

SP Medical Safety Catalogue



 **01952 288 999**
www.SPmedical.co.uk

**DISCOUNT AVAILABLE
FOR GP CONSORTIA
CALL FOR DETAILS**

We are delighted to introduce you to our 2014 catalogue

We have been extremely ambitious by introducing over 300 products under our new OPTICLAR brand. These fantastic ranges of premium quality, competitively priced products deliver outstanding performance. Backed by superb 5 year warranties and Service & Repair facilities you can be 100% confident that these products are innovative and also functional. We have tried to understand the day to day practical challenges and incorporated features to contribute to the smooth running of your organisation.

By introducing products with USB charging connections we have ensured you will have the capacity to recharge on the move via mains or car chargers. We have also introduced handy ENT otoscope tip dispensers enabling you to keep the working environment tidy and organised.

We hope you find this exciting edition packed with relevant, practical and functional products and combined with our first class knowledge we can find a solution that meets your need!

Easy ways to order

Telephone

01952 288 999

Fax

01952 606 112

Post

SP Services (UK) Ltd
Bastion House, Hortonwood 30
Telford, Shropshire, TF1 7XT

Website and email

For all on-line enquiries:

Web www.spmedical.co.uk

Email sales@spmedical.co.uk



Your local medical supplier is just a phone call away!

Our Promise To You:

Fast, reliable service

We continually review our stock levels to ensure we have the products you need fast. Any product in stock will be dispatched the same or following day.

First class Product Support and Service

We pride ourselves on the exceptional product knowledge we have built over many years of distributing medical products. We can provide unrivalled technical assistance, servicing and repairs so if any unfortunate occurrences arise we can assess and advise the best course of action.

Competitive Prices

We monitor our prices throughout the year to ensure we are offering value for money on products with the best features.

Call today for more information on how we can help you.

Flexible ways to pay

On account

Simply quote your account number when ordering.

New customers: please fax or post your company letterhead with your first order for instant account application.

Cheques

Please send your completed cheque with order, made payable to **SP Services (UK).Ltd**

Credit cards

All major credit cards are accepted. Please quote your card number, name and address to which the statement is sent and expiry date.

Debit cards

Simply quote your Maestro, Switch or Delta number, along with the issue number, expiry date and name and address.

Delivery terms

- All deliveries will be charged at cost, including large items, such as furniture and autoclaves, deliveries to overseas and northern scotland.
- Orders are usually despatched the same or following day and should be with you within 3-4 working days
- Our stock levels are always high, however we cannot always guarantee immediate availability of all items. Should an item be out of stock, we will do our utmost to advise you of the anticipated delivery time and to get the item to you in the shortest possible time.



Opticlar VisionMax 5 Examination Light
Page 139



Bollmann Classic Doctors Bag
Page 97



New Opticlar Diagnostic Range
Pages 6-43



BoSo Clinicus Aneroid Sphygmo
Page 65



New for 2014!



BoSo Nova® Table Top Aneroid Sphygmo
Page 68



Opticlar VisionMax 5 LED headlight
Page 59



AirPro3000 Nebuliser
Page 270



Opticlar P3 LED Pocket Otoscope
Page 7



BoSo Carat Synchro Pressure Monitor
Page 71



Opticlar D-Scope
Page 102



Kenz ECG305 Digital Electrocardiograph
Page 228



Children's Rainbow Mobile Lamp
Page 152

C O N T E N T S

Otosopes & Ophthalmoscopes Pages 4-51

- Mini Series Range 6 - 18
- Practice Range 19 - 29
- Specialist Ophthalmics 30 - 34
- Tips & Accessories 35 - 51

VISIONMED



Loupes & Personal Lighting Pages 52-63

- Loupes 52 - 55
- Personal Lighting 56 - 63

VISIONMAG



Blood Pressure Pages 64-77

- Aneroids 64 - 69
- Arterial Occlusive Disease Equipment 70
- Self Test Sphygs 71 - 75



Stethoscopes Pages 78-87

- GP Stethoscopes 78 - 79
- Cardiology Stethoscopes 80 - 81
- Nursing Stethoscopes 82 - 83
- Paediatric & Infant Stethoscopes 84



General Diagnostics Pages 88-93

- Thermometers 88 - 90
- Pen Torches 91
- Fob Watches 93



Cases & Bags Pages 94-101

- Cases 94 - 100
- Ampoule Holders 101
- Instrument Cases 101



Dermatology Pages 102-109

- Dermatoscopes 102 - 105
- Magnifiers, Skin models & Pens 106 - 107
- Biopsy Punches & Curettes 108 - 109



Instruments & Minor Ops Pages 110-137

- Gynaecology 110 - 115
- Proctology 116 - 117
- Cautery 118 - 121
- Electro & Crysurgery 122 - 123
- Instruments 124 - 133



Lighting Pages 138-155

- Examination Lamps 138 - 153
- Magnifying Lamps 154 - 155



Furniture Pages 156-191

- Couches 156 - 163
- Trolleys 165, 169 - 173
- Ward Screens 177 - 179



Scales & Height Measures Pages 192-201

- Floor Scales 192 - 193
- Column Scales 195, 198 - 199
- Wheelchair Scales 196



If you are unable to find exactly what you are looking for in this catalogue, please call us with details of your requirements.

See last pages for complete A to Z index

C O N T E N T S

Refrigeration Pages 202-205

- Pharmacy Fridges 202 - 204
- Freezers 204
- Portable Refrigeration 204



Accident & Emergency Pages 206-225

- Laryngoscopes 206 - 209
- Aspirators 210 - 213
- Tourniquets 218 - 219

VISIONAIR
MEDICAL



ECG Pages 226-241

- ECG Machines 226 - 237
- ECG Accessories 238 - 241



Dopplers Pages 242-245

- Arterial Occlusive Disease Equipment 242
- Pocket Dopplers 243 - 244
- Foetal Dopplers 245

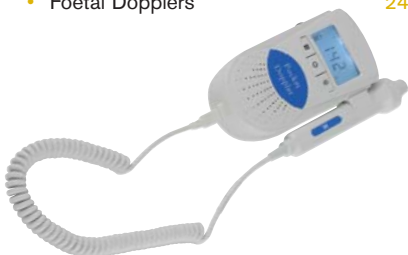

Spirometry & Respiratory Pages 246-271

- Spirometers & Consumables 246 - 263
- Nebulisers 266 - 271



Audiometry Pages 272-273

- Audiometers 272
- Tuning Forks 273



Disposable & Practice Sundries Pages 274-285

- Gloves & Dispensers 274 - 275
- Hand Towels and Toilet Paper 276 - 277
- Hand & Surface Cleaners 280 - 283

GUARDIAN
EMERGENCY & RESUSCITATION



Blood & Urine Analysis Pages 286-287

- Analyzers 286
- Blood Lancets 287
- Allergy Lancets 287



Health Care Pages 288-289

- Massagers & Infra Red Lamps 288
- Epicondylitis Clamps 289
- Heat Pads 289



Clothing, Footwear & Aseptics Pages 290-293

- Footwear 290 - 293
- Clothing 293



Training & Education Pages 294-297

- Skeletons 294
- Skulls 294
- Models 296 - 297



If you are unable to find exactly what you are looking for in this catalogue, please call us with details of your requirements.

See last pages for complete A to Z index

Welcome to the world of

OPTICLAR

A fascinating world of miniaturised optics, precision engineering and state of the art diagnostic technology.

International Brand Compatibility

Opticlar equipment has been cleverly developed to offer international compatibility with other diagnostic brands.



Whatever make of equipment you have in practice, Opticlar have a solution for upgrades, spares and accessories. Simply call us and we can help you choose the perfect solution to unify new and existing equipment, providing the best performance and great cost-savings in one package.

True-Tone LED

Where indicated, Opticlar pocket otoscopes and ophthalmoscopes feature TrueTone LED illumination, developed to provide the very best diagnostic illumination and an impressive longevity of over 10,000 hours continual use. So confident are we of the performance of the TrueTone LED system, we offer an **unrivalled 10 year warranty** on the LED illumination and substantial cost-savings over the life of an instrument.

Five Year Warranty

Opticlar include an industry-leading 5 year manufacturers warranty on all instruments and a **10 year warranty on LED light sources**. Subject to registration.

At the heart of every Opticlar instrument there lies a precision LED bulb utilising the latest technology and materials.

Our specialist LED designers ensure that Opticlar instruments, from concept to physical product, are designed to perform efficiently and optimally with LED illumination.



The advantages of Opticlar LED instruments are significant

Environmental – with Opticlar’s new generation of LED bulbs, battery life is increased significantly; in excess of 100 hours for AA and C cells as well as up to 20 hours for rechargeable cells, resulting in the disposal of fewer batteries, less charging time required, less cost for surgeries and minimal impact on the environment.

Bulb Life – typically miniaturised halogen bulbs have a working life of approximately 25 hours, Opticlar LED bulbs have a working life in excess of 10,000 hours. **In practice this means no more replacement bulb costs.**

Multivoltage capability – our multivoltage LED’s and long life mean that holding bulbs of differing voltages is a thing of the past. With OPTICLAR LED there is no need to worry about the differing input voltages of equipment, our LED’s easily cater for differing input voltages with minimal change in performance.

Enhanced diagnostic capability – unlike contemporary gas filled bulbs such as Xenon and halogen, OPTICLAR LED bulbs retain their original performance for their complete lifetime. Our LED’s retain their performance as power sources discharge unlike gas filled bulbs which offer reduced performance levels as batteries discharge.

Optical Clarity – our hand held diagnostic instruments benefit from their miniaturised optics guaranteeing excellent optical properties, attention to detail and ease of use in all situations.

Your local medical supplier is just a phone call away. See cover for full details

Prices shown are exclusive of VAT and delivery

Our VISION is for total quality

VISION_{LED}**MED** See pages 4-51

The VISIONMED range encapsulates the Diagnostic range of the OPTICLAR brand. This modern interpretation of the classic, popular diagnostic set combines superb performance at competitive prices. They are specially designed to harness miniaturised optics, precision engineering and state of the art technology.

The premium quality optics and advanced LED light sources ensure the optimum level of illumination is delivered offering medical practitioners a comprehensive range of unique benefits at extremely competitive prices.



VISION_{LED}**MAG** See pages 52-55

The VISIONMAG loupes are available in a variety of magnifications and specifications to cater for a wide range of disciplines. They are ideal for General Surgery, Dermatology, ENT, Ophthalmology, Oral and Maxillofacial, Dentistry and Veterinary medicine as well as many other types of uses.



VISION_{LED}**MAX** See pages 56-63

The VISIONMAX specialist lighting has been designed for the Medical Professional and enables examinations, minor procedures and surgical processes to be effectively performed.

Opticlar LED enables medical staff to perform their examinations and procedures with the optimum light and we strive to create the very best lighting conditions.

By selecting Opticlar LED luminaires you are ensuring the very best lighting conditions and the most energy efficient and practical type of lighting available.



VISION_{LED}**AIR** See pages 206-209

The VISIONAIR laryngoscope range combines modern fibre optic technology and multivoltage LEDs to ensure the range of blades and handles provide the anaesthetist with the very best combination of light and blade design.

All of our VA Mono blades are to recognised patterns and comply with ISO 7376 Green Standard and are therefore compatible not only with the OPTICLAR range of handles but also with other manufacturers handles that are Green Standard compliant.



Your local medical supplier is just a phone call away. See cover for full details

Prices shown are exclusive of VAT and delivery

Otosscopes & Ophthalmoscopes **Pocket Instruments**



Opticlar Pocket Professional Diagnostic Equipment

High quality LED illumination is core to each Opticlar pocket instrument, providing optimal illumination for the intended purpose of the instrument. With high quality materials and precise construction, Opticlar Pocket Diagnostic Instruments are guaranteed to provide years of reliable service with minimal running costs. Opticlar pocket instruments are clearly defined into three categories:

P3 K-Scope ENT Instruments – charismatic design in a Kaleidoscope choice of colours!

P2 Mini Pro Diagnostic Instruments – slim line pocket handles and total diagnostic performance with TrueTone LED technology, at an affordable price.

P1 Mini Plus Diagnostic Instruments – premium Hygena metal handle system with rotary on/off control, powers a FO otoscope and pocket ophthalmoscope instrument.

Advantages of OPTICLAR LED pocket instruments

Environmental

- Most efficient and appropriate LEDs significantly increase battery life: AA cells - in excess of 100 hours
- Reduces the cost of disposal of batteries

Bulb Life & Performance

- Working life in excess of 10,000 hours
- Fantastic 10 year LED warranty
- Retain performance throughout lifetime
- Engineered to provide the optimum level of illumination
- Ensures superb levels of colour rendering index
- Heat management system guarantees instruments remain cool and maintains consistent LED performance



Opticlar Pocket professional Diagnostic Instruments – Contents:

- Page 7 – P3 K-Scope, product overview
- Page 8 – P3 K-Scope, set options and colours
- Page 9 – P3 K-Scope, ear care station
- Page 10 – P2 Mini Pro, product overview
- Page 11 – P2 Mini Pro, otoscope
- Page 12 – P2 Mini Pro, ophthalmoscope
- Page 13 – P2 Mini Pro, combination diagnostic sets
- Page 14 – P2 Mini Pro, rechargeable diagnostic sets
- Page 15 – P2 Mini Pro, pocket diagnostic wall station
- Page 16 – P1 Mini Plus, product overview
- Page 17 – P1 Mini Plus, otoscopes and ophthalmoscopes
- Page 18 – P1 Mini Plus, combination diagnostic sets



Your local medical supplier is just a phone call away. See cover for full details

Prices shown are exclusive of VAT and delivery

P3 K-Scope Otoscope Otoscopes & Ophthalmoscopes

P3

K-Scope LED Otoscope



Available in Black, Blue or White. Please specify colour when ordering. If no colour is specified black will be supplied

Direct Illumination shows large lit area with room to manoeuvre instruments compared to Fibre Optic LED



D.I.

F.O.

Green LED technology



P3 Handles

- Double ended, enabling insertion of batteries without removing instrument head
- Pocket clip with fully tested on-off switch
- When used with Alkaline AA batteries and OPTICLAR LED instrument heads, battery life is > 100 hours continuous use.



OPTICLAR VISION MED
LED

OPTICLAR P3 LED Direct Illumination Pocket Otoscope

- Superb field of view with excellent level of illumination
- Excellent viewing capabilities with large viewing port and window
- Superior quality, ergonomic and non slip handles
- Long life switch tested for 10,000 cycles
- Convenient integral pocket clip
- Direct illumination to the point of examination
- Wide viewing aperture allows the insert of instruments
- Attached 3x rotating viewing window, cannot be mislaid
- Disposable tips in 2.5mm and 4.0mm diameter, compatible with premium brand German otoscopes so ideal for use in surgeries with a mixture of equipment

OPTICLAR P3 LED Fibre Optic Pocket Otoscope

- Fibre optic with distal illumination
- Guarded tip slot prevents fibre optic sheath breakage
- 3x rotating viewing window, cannot be lost
- Excellent viewing capabilities with large viewing port and window
- Pneumatic testing via inbuilt insufflation port
- Disposable tips in 2.5mm and 4.0mm diameter, compatible with premium brand German otoscopes so ideal for use in surgeries with a mixture of equipment
- 2 piece modern design



Your local medical supplier is just a phone call away. See cover for full details

Prices shown are exclusive of VAT and delivery

Otoscopies & Ophthalmoscopes P3 Otoscope Sets

P3 LED Fibre Optic Pocket Otoscope sets

- Choice of P3 K-Scope Otoscope in F.O. or D.I. in 3 colour options
- P3 Battery Handle
- Choice of Velcro Pouch or Zip Case
- Selection of 2.5mm and 4mm Single Use Tips



Direct Illumination

100.012.023	£64.00
P3 DI LED Otoscope with Velcro Case	
100.012.021	£74.00
P3 DI LED Otoscope with Zip Case	

Fibre Optic

100.012.020	£79.00
P3 LED FO Otoscope with Zip Case	
100.012.022	£69.00
P3 LED FO Otoscope with Velcro Case	

OPTICLAR H-Range Specula Tips - Single Use

- For use with all Opticlar otoscopes
- 2.5mm and 4.0mm end diameter with premium brand German tip fitting
- Compatible with premium German Brand pocket sets and fibre optic standard sets



		50	100	250	500	1000	5000	10000
100.250.000	2.5mm dia tips	£8.00	£11.00	£18.00	£32.00	£54.00	£239.00	£435.00
100.400.000	4.0mm dia tips	£8.00	£11.00	£18.00	£32.00	£54.00	£239.00	£435.00

Your local medical supplier is just a phone call away. See cover for full details
 Prices shown are exclusive of VAT and delivery

Ear Care Station Oscopes & Ophthalmoscopes

Available in Black, Blue or White.
Please specify colour when
ordering. If no colour is specified
black will be supplied



100.012.026/1 Shown

P3 Ear Care Station

- Wall Mounted Tip Dispenser Complete with Lid Mounted Instrument Receptacles and Side Mounted Holders
- Ideal for disposable noots ear tanks and ear irrigation accessories such as jet tips, currettes etc.
- Supplied with Opticlar P3 LED Pocket otoscope
- Superb for convenient location in ear irrigation treatment room as it stores all commonly used equipment
- Fantastic, space-saving solution for the treatment room and ear clinic
- Choice of 1 or 2 side holsters, to hold single-use noots tank or plastic accessory beaker (included)
- Base unit suitable for use with most makes of pocket otoscopes

Direct Illumination

100.012.027 P3 K-Scope Ear Care Station with D.I. LED Oscope	£109.00
100.012.027/1 As above with 1 x Side Holster	£154.00
100.012.027/2 As above with 2 x Side Holster	£189.00

Fibre Optic

100.012.026 P3 K-Scope Ear Care Station with F.O. LED Oscope	£119.00
100.012.026/1 As above with 1 x Side Holster	£164.00
100.012.026/2 As above with 2 x Side Holster	£199.00

Your local medical supplier is just a phone call away. See cover for full details

Prices shown are exclusive of VAT and delivery

Otosopes & Ophthalmoscopes P2 Mini Pro LED Diagnostic Instruments

P2 Mini Pro LED Diagnostic Instruments

OPTICLAR VISIONMED P2 Pocket Otoscope

Excellent illumination for increased clarity and diagnostic ability average bulb life greater than 10,000 hrs

- Superior quality slimline handles – comfortable and non slip
- Double ended design aids battery removal
- Long life switch tested for thousands of cycles
- Convenient integral pocket clip
- True Tone LED with fibre optic distal illumination
- Guarded tip slot prevents fibre optic sheath breakage
- 3x rotating viewing window, cannot be lost
- Excellent viewing capabilities with large viewing port and window
- Pneumatic testing with integral insufflation port
- Disposable tips in 2.5mm and 4.0mm diameter, compatible with German brand – so ideal for use in surgeries with a mixture of equipment
- 2 piece modern design



OPTICLAR VISIONMED P2 Ophthalmoscope

- Superb miniaturised optics provide clear images
- Impact resistant plastic handles and precise construction ensure ophthalmoscope delivers reliability and performance.
- True-Tone LED illumination – Excellent illumination for increased clarity and diagnostic ability
- Average LED life greater than 10,000 hrs
- Superior quality handles – comfortable and non slip, double ended design aids battery removal
- Long life switch tested for thousands of cycles
- Convenient integral pocket clip
- Handle powered by supplied AA batteries
- Full range of apertures, Large spot, small spot, fixation star, slit and red free
- 18 lenses from -20d to +20d to cater for common refractive errors +/- 1,2,3,4,6,8,10,15,20d



Lens range

- 20 15 10 8 6 1-4  1-4 6 8 10 15 20 +

Apertures



P2 Handles

- Double ended, enabling insertion of batteries without removing instrument head
- Pocket clip with fully tested on-off switch
- Use with Alkaline AA batteries.



Your local medical supplier is just a phone call away. See cover for full details

Prices shown are exclusive of VAT and delivery

P2 Mini Pro LED Otoscope Sets Otoscopes & Ophthalmoscopes

P2 Mini Pro Pocket Otoscope Set

- Comes with either a Velcro Pouch or Zip Case
- Set of 2.5mm and 4mm disposable tips
- Fibre Optic



100.010.022



100.010.020

100.010.022	P2 LED Otoscope with Velcro Case	£79.00
100.010.020	P2 LED Otoscope with Zip Case	£89.00

'P2 Mini Pro Otoscopes and Ophthalmoscopes include TrueTone LED illumination, for the brightest view and natural colour tone'. LED guaranteed for 10 years

P2 Mini Pro Rechargeable Otoscope Set

Combining the P2 Mini Pro LED Fibre Optic Otoscope with the portable Mini Pro single port desk charger – compact, stylish and always ready to use.

- P2 Mini Pro fibre optic otoscope with lithium ion rechargeable P2 Mini Pro slimline handle
- TrueTone LED illumination – guaranteed for 10 years
- Compact desk charger with a footprint of just 58 x 58mm!
- Charge time: 3.5 hours
- Working duration: > 5 hours
- Set includes:
 - P2 FO Otoscope
 - Selection of tips
 - P2 Mini Pro single port charger
 - 240v mains transformer
 - Carry case
 - Lithium ion P2 Mini Pro slimline handle



100.014.020	P2 Mini Pro FO Otoscope Set, Rechargeable	£169.00
-------------	---	---------

Your local medical supplier is just a phone call away. See cover for full details
Prices shown are exclusive of VAT and delivery

Otosscopes & Ophthalmoscopes P2 Mini Pro LED Ophthalmoscope Sets

P2 Mini Pro Ophthalmoscope Set

- Comes with either a Velcro Pouch or Zip Case
- Ideal for general examinations in the ward, practice or home visits



100.010.025 P2 LED Ophthalmoscope with Velcro Case **£114.00**

100.010.024 P2 LED Ophthalmoscope with Zip Case **£124.00**

'P2 Mini Pro Otoscopes and Ophthalmoscopes include TrueTone LED illumination, for the brightest view and natural colour tone'. LED guaranteed for 10 years

P2 Mini Pro Rechargeable Ophthalmoscope Set

Combining the P2 Mini Pro LED Ophthalmoscope with the portable Mini Pro single port desk charger – compact, stylish and always ready to use.

- P2 Mini Pro ophthalmoscope with rechargeable lithium ion P2 Mini Pro slim line handle
- TrueTone LED illumination – guaranteed for 10 years
- Compact desk charger with a footprint of just 58 x 58mm!
- Charge time: 3.5 hours
- Working duration: > 5 hours
- Set includes:
 - P2 Ophthalmoscope:
 - P2 Mini Pro single port charger
 - 240v mains transformer
 - Carry case
 - Lithium ion P2 Mini Pro slimline handle



100.014.024

P2 Mini Pro FO Oscope Set, Rechargeable

£214.00

Your local medical supplier is just a phone call away. See cover for full details

Prices shown are exclusive of VAT and delivery

P2 Mini Pro LED Diagnostic Sets Oscopes & Ophthalmoscopes

P2 Mini Pro Combination Diagnostic Sets

Include:

- P2 F.O. LED Otolaryngoscope
- P2 LED Ophthalmoscope
- Choice of 1 or 2 handles
- Velcro Fastening Pouch or Zip Case
- Selection of 2.5mm and 4mm tips
- Compatible with premium German brands



100.010.012	£169.00
P2 mini diagnostic set with zip case - 1 handle	
100.010.010	£189.00
P2 mini diagnostic set with zip case - 2 handle	

'P2 Mini Pro Oscopes and Ophthalmoscopes include TrueTone LED illumination, for the brightest view and natural colour tone'. LED guaranteed for 10 years

P2 Mini Pro Combination Diagnostic Set - with Pouch



100.010.013	£159.00
P2 mini diagnostic set with pouch - 1 handle	
100.010.011	£179.00
P2 mini diagnostic set with pouch - 2 handle	

Your local medical supplier is just a phone call away. See cover for full details

Prices shown are exclusive of VAT and delivery

Otosopes & Ophthalmoscopes P2 Mini Pro LED Diagnostic Sets

P2 Mini Pro Combination Diagnostic Sets

The P2 Mini Pro rechargeable diagnostic set combines quality instruments with the convenience and practicality of a rechargeable system. The P2 Mini Pro FO Otoscope and Ophthalmoscope perform brilliantly in a wide sphere of clinical settings, including general practice, community visits and hospital departments. TrueTone LED illumination is standard, providing a quality illumination with superb, natural colour rendering - guaranteed in use for 10 years!

The portable desk charger is available in single or double port configurations for use with single or twin handle mini pro diagnostic sets.



P2 Mini Pro Combination Diagnostic Set, 1 Handle

Set Includes:

- P2 Mini Pro FO Otoscope
- Selection of tips
- P2 Mini Pro Ophthalmoscope
- P2 Mini Pro single port desk charger
- 1 x P2 Mini Pro slim line rechargeable handle
- Storage case

Specifications:

- Charge Time: 3.5 hours
- Working Duration: > 5 hours
- Charger Dimensions: 58 (w) x 58 (d) x 52 (h) mm
- Battery Type: Lithium ion



100.014.012

£245.00

P2 Mini Pro Diagnostic Set, rechargeable, single port

'P2 Mini Pro Otoscopes and Ophthalmoscopes include TrueTone LED illumination, for the brightest view and natural colour tone'. LED guaranteed for 10 years



P2 Mini Pro Combination Diagnostic Set, 2 Handles

Set Includes:

- P2 Mini Pro FO Otoscope
- Selection of tips
- P2 Mini Pro Ophthalmoscope
- P2 Mini Pro twin port desk charger
- 2 x P2 Mini Pro slim line rechargeable handles
- Storage case
-

Specifications:

- Charge Time: 3.5 hours
- Working Duration: > 5 hours
- Charger Dimensions: 128 (w) x 58 (d) x 52 (h) mm
- Battery Type: Lithium ion

100.014.010

£295.00

P2 Mini Pro Diagnostic Set, rechargeable, twin port

Your local medical supplier is just a phone call away. See cover for full details

Prices shown are exclusive of VAT and delivery

P2 Mini Pro LED Diagnostic Sets Oscopes & Ophthalmoscopes

P2

Mini Pro Twin Handle Wall Station Diagnostic Centre

New, innovative wall mounted diagnostic centre that maximises convenience and security and remains stationed in a specific location, ready to use.

- P2 Mini-Pro combination diagnostic set, with wall station holder
- P2 Mini Pro Ophthalmoscope
- P2 Mini Pro Fibre Optic or Direct Illumination Oscope
- 2 x P2 Mini Pro slimline battery handles
- Twin port wall unit with accessory box and tip dispenser
- Selection of single use tips
- Perfect for the treatment room or surgery with limited space
- Instruments are always to hand and easy to locate
- Original, smart design
- Hygienic and easy to clean
- Tip dispenser with tip size markings
- Can also take Heine pocket, Riester pocket, KaWe Piccolight and Keeler Jazz instruments and tips

'P2 Mini Pro Oscopes and Ophthalmoscopes include TrueTone LED illumination, for the brightest view and natural colour tone'. LED guaranteed for 10 years

OPTICLAR VISION MED
LED



100.012.024	£239.00
P2 Mini Pro Wall Diagnostic Centre with FO Oscope	
100.012.025	£234.00
P2 Mini Pro Wall Diagnostic Centre with DI Oscope	

Your local medical supplier is just a phone call away. See cover for full details
Prices shown are exclusive of VAT and delivery

Otoscopies & Ophthalmoscopes P1 Mini Plus LED Diagnostic Instruments

P1 Mini Plus LED Diagnostic Instruments

OPTICLAR VISIONMED P1 Pocket Otoscope

Excellent illumination for increased clarity and diagnostic ability average bulb life greater than 10,000 hrs

- True Tone LED with fibre optic distal illumination
- Guarded tip slot prevents fibre optic sheath breakage
- 3x rotating viewing window, cannot be lost
- Excellent viewing capabilities with large viewing port and window
- Pneumatic testing with integral insufflation port
- Disposable tips in 2.5mm and 4.0mm diameter, compatible with premium German brand otoscopes so ideal for use in surgeries with a mixture of equipment
- 2 piece modern design



OPTICLAR VISIONMED P1 Ophthalmoscope

- Superb miniaturised optics provide clear images
- Impact resistant plastic and precise construction ensure ophthalmoscope delivers reliability and performance
- LED illumination – Excellent illumination for increased clarity and diagnostic ability average bulb life greater than 10,000 hrs
- Superior quality metal handles – comfortable and non slip, double ended design aids battery removal
- Full range of apertures, large spot, small spot, fixation star, slit and red free
- 18 lenses from -20d to +20d to cater for common refractive errors +/- 1,2,3,4,6,8,10,15,20d



Lens range



Apertures



'P1 Mini Plus Ophthalmoscopes include TrueTone LED illumination, for the brightest view and natural colour tone'. LED Guaranteed for 10 years

P1 Mini Plus Metal Handles

- Superior quality slimline metal handles – comfortable and non slip
- Convenient integral pocket clip
- Rotary on/ off switch if used with LEDs or rheostat if used with halogen or xenon instruments
- Fully compatible with German brand screw thread pocket instruments
- Double ended, enabling insertion of batteries without removing instrument head
- Use with Alkaline AA batteries.



Your local medical supplier is just a phone call away. See cover for full details

Prices shown are exclusive of VAT and delivery

P1 Mini Plus LED Diagnostic Sets Otoscopes & Ophthalmoscopes

P1 Mini Plus LED Otoscope Sets

Includes:

- P1 Mini Plus F.O. Otoscope
- Selection of 2.5mm or 4mm single use tips
- P1 Metal Battery Handle
- Choice of Velcro Pouch or Zip Case



100.015.021 **£126.00**
P1 Mini Plus LED Otoscope with Velcro Case

100.015.020 **£139.00**
P1 Mini Plus LED Otoscope with Zip Case

P1 Mini Plus LED Ophthalmoscope Sets

Includes:

- P1 Mini Plus Ophthalmoscope
- P1 Metal Battery Handle
- Choice of Velcro Pouch or Zip Case



100.015.023 **£144.00**
P1 LED Otoscope with Velcro Case

100.015.022 **£154.00**
P1 LED Otoscope with Zip Case

Lens range

- 20 15 10 8 6 1-4 1-4 6 8 10 15 20 +

Apertures



Your local medical supplier is just a phone call away. See cover for full details

Prices shown are exclusive of VAT and delivery

Otosscopes & Ophthalmoscopes P1 Mini Plus LED Diagnostic Sets

P1 MINI Plus Diagnostic Set - Metal handle with Zip Case



Includes:

- P1 Mini Plus F.O. Otoscope
- P1 Mini Plus Ophthalmoscope
- Selection of 2.5mm or 4mm single use tips
- 1 or 2 P1 Metal Battery Handles
- Zip Case



100.015.012	£209.00
P1 mini diagnostic set - 1 handle	
100.015.010	£259.00
P1 mini diagnostic set - 2 handle	

Lens range: - 20 15 10 8 6 1-4 1-4 6 8 10 15 20 +

Apertures:

P1 Mini Plus Ophthalmoscopes include TrueTone LED illumination, for the brightest view and natural colour tone. LED Guaranteed for 10 years

P1 MINI Plus Diagnostic Set - Metal handle with Pouch



100.015.013	£199.00
P1 mini diagnostic set - 1 handle	
100.015.011	£249.00
P1 mini diagnostic set - 2 handle	

Lens range: - 20 15 10 8 6 1-4 1-4 6 8 10 15 20 +

Apertures:

Your local medical supplier is just a phone call away. See cover for full details

Prices shown are exclusive of VAT and delivery



Opticlar VisionMed Practice Diagnostic Instruments

The Opticlar VisionMed Practice range, encompasses a range of ENT, Ophthalmic and Dermatology diagnostic instruments with outstanding features and performance.

At the core, each Practice instrument has TrueTone LED illumination technology, providing the brightest illumination whilst retaining excellent colour-rendering qualities and natural tissue tones.

With a versatile range of power supplies to choose from, including battery, rechargeable and wall systems, Opticlar VisionMed Practice instruments can be configured to suit all needs and budgets.

Opticlar rechargeable options include Lithium Polymer cells as standard and boast market-leading charge times, running duration and longevity. The unique and practical ADAPT USB handle can be charged from mains, car or anywhere with a powered USB outlet.

Opticlar Practice Diagnostic Instruments – Contents:

Page 19-21	Practice Instruments, product overview and handle power options
Page 22	Practice S1 Oscope Sets
Page 23	Practice L28 Ophthalmoscope Sets
Page 24-27	Practice Combination Sets
Page 28-29	EENT Sets
Page 30-34	Specialist Ophthalmic Instruments and Sets
Page 35	Tips and Dispensers
Page 36-38	Power Supplies
Page 39-41	ENT Instruments
Page 42-45	Ophthalmic Instruments

The Power Behind Opticlar Practice Diagnostic Instruments

Opticlar Practice power supplies are available in three ranges:



VisionMed ADAPT – Battery and Rechargeable Systems

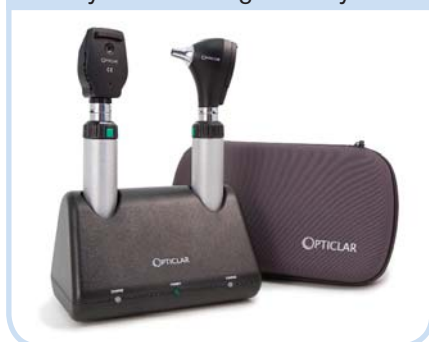

VisionMed E-LITHIUM – Rechargeable Desk Systems



VisionMed STATION – Wall-Mounted Systems



VisionMed ADAPT

As the name suggests, an adaptable handle system that has a robust metal sleeve at its core, with a knurled surface for maximum grip. ADAPT handles come in battery (2 x C cell), USB lithium rechargeable and desk lithium rechargeable options. Handles can be upgraded and swapped between C battery and rechargeable, by simply interchanging cells and end caps, making it a truly flexible option for all situations.

Running duration:

C-battery > 125 hours

USB-Lithium > 20 hours

Desk-Lithium > 20 hours

Charge times:

USB-Lithium – 12 hours (initial), 8 hours (normal)

Desk-Lithium – 2 hours (approx)



Your local medical supplier is just a phone call away. See cover for full details

Prices shown are exclusive of VAT and delivery

Otosscopes & Ophthalmoscopes Practice Diagnostic Instruments

VisionMed E-LITHIUM

E-LITHIUM handles are manufactured from lightweight composite materials with compact dimensions, particularly suited to practitioners with smaller hands and for carrying around in a coat pocket. The ribbed handle is easy to grip and comfortable to use. A rotary control allows the LED brightness to be adjusted easily.

The E-LITHIUM handle can be charged using the Opticlar VisionMed single or twin port desk charger, with auto-on / auto-off feature. This function means the E-LITHIUM is always ready to use and protects the handle from accidental charge damage.

Running duration:

E-Lithium > 10 hours

Charge times:

2 hours (approx)



Auto on/off feature – instrument comes on automatically when removed from charger

VisionMed WALL STATION

Opticlar VisionMed wall mounted diagnostic stations, provide mains power for the VisionMed Practice range of instruments. Available in single-bay or twin-bay configurations with fixed cord handles with a working radius of more than 3 metres. The smooth design and rounded profile is hygienic, easy to clean and minimises dust traps.

- Auto on/off bays
- Rheostat brightness control on each handle
- Locking collars secure instrument heads against loss and theft
- Easy to assemble and install
- Available in wall, rail, mobile stand and pole mount options

Additional accessory bays available:

- Accessory storage box / tip dispenser
- Infra-Red thermometer holder, for Braun, AW or other thermometer
- BoSo Nova large dial sphygmomanometer



Locking bayonet system for easy changing of heads.

Smooth action rotary brightness control.

Your local medical supplier is just a phone call away. See cover for full details

Prices shown are exclusive of VAT and delivery

OPTICLAR VISIONMED S1 Practice Diagnostic Instruments

The Opticlar S1 Practice range provides professionals with the diagnostic capabilities they require in a high quality yet affordable format featuring simple, functional design and elegant detailing.



VisionMed Practice instruments include **TrueTone LED illumination**, the standard providing the brightest view, finest colour rendering and natural tone. LED guaranteed for 10 years

Opticlar S1 Practice LED Fibre Optic Oscope

- TrueTone LED illumination
- Distal fibre optics gives cool light to examination site with no reflections and provides excellent view of the tympanic membrane
- Swivel viewing lens cannot be lost and is guarded on lower edge from potential breakage
- 3x magnification from scratch proof window lens
- Wide angle viewing window for easy instrumentation under magnification
- Sealed system allows for pneumatic otoscopy
- MultiVoltage system, works with all power sources
- Disposable tips in 2.5mm or 4.0mm diameters
- Head available with premium German Auto-lock fitting or American style Twist-lock fitting. Please specify at time of ordering, otherwise American style fit is supplied as standard.



Opticlar L28 Practice Ophthalmoscope

- Superior miniaturised optics facilitates entry into even very small diameter pupils
- Polarising filter practically eliminates corneal reflex and can be used on all apertures
- Sealed optics for long life and reduced running cost
- 28 lenses from -25 to +40d
- Independently selectable red free filter for use on all apertures provides increased contrast
- 18 filter/aperture combinations for increased diagnostic capabilities
- Cobalt blue filter to help detect corneal abrasions



Easy to operate lens wheel for superior focus



Select from 3 filter settings: Redfree, Clear, Polarised

Smooth action thumb wheel for aperture selection

Lens range

- 25 20 15 1-10 1-10 12 15 20 40 +

Apertures



With contrast filter



With polarisation filter

Your local medical supplier is just a phone call away. See cover for full details

Prices shown are exclusive of VAT and delivery

Otosscopes & Ophthalmoscopes **S1 Practice Oscope Sets**

**125 hours
continuous
use from
one set of
batteries**

VisionMed Practice instruments include **TrueTone LED** illumination, the standard providing the brightest view, finest colour rendering and natural tone. LED guaranteed for 10 years

*American style tip fitment as standard.
Please specify German style tip if required.*



S1 Practice Oscope Set – Battery Version

Includes:

- S1 Practice F.O. Oscope
- Adapt C-Cell Battery Handle
- Selection of 2.5mm and 4mm tips
- Zip case

100.020.040 **£180.00**
S1 Oscope Battery handle with Zip Case

S1 Practice Oscope Set – USB Version

Includes:

- S1 Practice F.O. Oscope
- Adapt USB Lithium Rechargeable Handle plus USB lead
- Selection of 2.5mm and 4mm tips
- Zip case



100.020.041 **£236.00**
S1 Oscope USB handle with Zip Case

S1 Practice Oscope Adapt Desk System

Includes:

- S1 Practice F.O. Oscope
- Adapt Lithium Rechargeable Metal Handle
- Selection of 2.5mm and 4mm tips
- Zip case
- Single port charger



100.020.042 **£295.00**
S1 Oscope Adapt Rechargeable handle with Zip Case

S1 Practice Oscope – E-Lithium Desk System

- E-Lithium Ion Rechargeable handle
- Single port charger
- Selection of 2.5mm and 4mm tips
- Zip case
- Single port charger



100.025.040 **£261.00**
S1 Oscope E-Lithium Rechargeable handle with Zip Case

OPTICLAR S1 LED Station – Wall Mounted Oscope

Includes:

- S1 Practice F.O. Oscope
- Single Bay Wall Station
- Selection of 2.5mm and 4mm tips



100.030.040 **£222.00**
S1 Oscope and single handle wall unit

100.000.141 **£199.00**
Mobile Trolley Stand with conversion plate

Your local medical supplier is just a phone call away. See cover for full details

Prices shown are exclusive of VAT and delivery

L28 Practice Ophthalmoscope Sets Otosopes & Ophthalmoscopes

VisionMed Practice instruments include TrueTone LED illumination, the standard providing the brightest view, finest colour rendering and natural tone. LED guaranteed for 10 years



L28 Practice Ophthalmoscope Set – Battery Version

Includes:

- L28 Practice Ophthalmoscope
- Adapt C-Cell Battery Handle
- Zip case

100.020.050

£263.00

L28 Ophthalmoscope, Battery handle with Zip Case

L28 Practice Ophthalmoscope Set – USB Version

Includes:

- L28 Practice Ophthalmoscope
- Adapt USB Lithium Rechargeable Handle plus USB lead
- Zip case



100.020.051

£319.00

L28 Ophthalmoscope, USB handle with Zip Case

L28 Practice Ophthalmoscope Adapt Desk System

Includes:

- L28 Practice Ophthalmoscope
- Adapt Lithium Rechargeable Metal Handle
- Single port charger
- Zip case



100.020.052

£399.00

L28 Ophthalmoscope, Adapt Rechargeable handle with Zip Case

L28 Practice Ophthalmoscope – E-Lithium Desk System

- L28 Practice Ophthalmoscope
- E-Lithium Ion Rechargeable handle
- Single port charger
- Zip case



100.025.050

£349.00

L28 Ophthalmoscope, E-Lithium Rechargeable handle with Zip Case

OPTICLAR L28 LED Station – Wall Mounted Ophthalmoscope

Includes:

- L28 Practice Ophthalmoscope
- Single Bay Wall Station



100.030.050

£299.00

L28 Ophthalmoscope and single handle wall unit

100.000.041

£199.00

Mobile Trolley Stand with conversion plate

Your local medical supplier is just a phone call away. See cover for full details

Prices shown are exclusive of VAT and delivery

Otoscopy & Ophthalmoscopy S1 Practice Diagnostic Sets

OPTICLAR VISIONMED S1 Practice Diagnostic Sets

The OPTICLAR S1 range provides professionals with the diagnostic capabilities they require in a high quality yet affordable format featuring simple, functional design and elegant detailing.

See pages 19-21 for full product description.

American style tip fitment as standard.

Please specify German tip fitment if required.

VisionMed Practice instruments include TrueTone LED illumination, the standard providing the brightest view, finest colour rendering and natural tone. LED Guaranteed for 10 years



Practice Diagnostic Set – Battery Handle

Includes:

- S1 Practice F.O. Otoscope
- L28 Practice Ophthalmoscope
- 1 Adapt C-Cell Battery Handle
- Selection of 2.5mm and 4mm tips
- Zip case



100.020.020 **£259.00**
S1 Practice Diagnostic Set - Adapt C cell
Battery Handle



Practice Diagnostic Set – Adapt USB Rechargeable Handle

Includes:

- S1 Practice F.O. Otoscope
- L28 Practice Ophthalmoscope
- 1 Adapt USB Rechargeable Handle
- Selection of 2.5mm and 4mm tips
- Zip case

100.020.021 **£399.00**
S1 Practice Diagnostic Set - Adapt USB
Rechargeable Handle

Your local medical supplier is just a phone call away. See cover for full details

Prices shown are exclusive of VAT and delivery

S1 Practice Diagnostic Sets Oscopes & Ophthalmoscopes

S1 Practice Diagnostic Set Adapt Desk Systems

100.020.022

Includes:

- S1 Practice F.O. Otoscope
- L28 Practice Ophthalmoscope
- Adapt Lithium Rechargeable Metal Handle
- Single port or twin port charger
- Auto on/off feature
- Selection of 2.5mm and 4mm tips
- Zip case



100.020.023



100.020.022 **£455.00**
S1 Practice Diagnostic Set - 1 x Adapt Lithium Rechargeable Handle, Single Port Charger

100.020.023 **£599.00**
S1 Practice Diagnostic Set - 2 x Adapt Lithium Rechargeable Handles, Twin Port Charger

S1 Practice Diagnostic Set E-Lithium Desk Systems

Includes:

- S1 Practice F.O. Otoscope
- L28 Practice Ophthalmoscope
- E-Lithium Rechargeable Handle
- Single port or twin port charger
- Auto on/off feature
- Selection of 2.5mm and 4mm tips
- Zip case



100.025.011

100.025.010



100.025.010 **£419.00**
S1 Practice Diagnostic Set - 1 x E-Lithium Rechargeable Handle, Single Port Charger

100.025.011 **£499.00**
S1 Practice Diagnostic Set - 2 x E-Lithium Rechargeable Handles, Twin Port Charger

Your local medical supplier is just a phone call away. See cover for full details

Prices shown are exclusive of VAT and delivery

Otosscopes & Ophthalmoscopes **S1 Practice Wall Stations**

OPTICLAR VISIONMED S1 Wall Stations

American style tip fitment as standard.

Please specify German tip fitment if required.

S1 Practice Twin Handle Wall Station

Includes:

- S1 Practice F.O. Otoscope
- L28 Practice Ophthalmoscope

100.030.010 **£441.00**
S1 LED Wall Mounted Diagnostic Centre

100.000.142 **£199.00**
Mobile Trolley Mount with mounting plate



VisionMed Practice instruments include TrueTone LED illumination, the standard providing the brightest view, finest colour rendering and natural tone. LED guaranteed for 10 years



Mobile Trolley Mount, For S1 Practice Wall Systems

- Portable wheeled base for OPTICLAR Wall Stations
- Provides mains powered instruments the ability to move between ward, department or treatment room
- Available for Single Handle and Twin Handle wall units

100.000.141 **£199.00**
Mobile Trolley Mount (Single) with mounting plate

100.000.142 **£199.00**
Mobile Trolley Mount (Double) with mounting plate

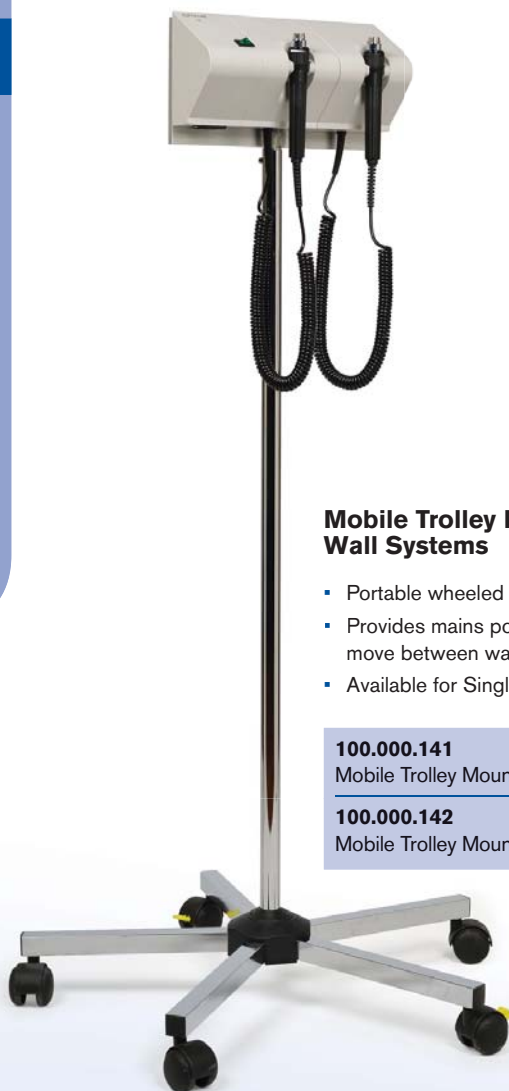

Your local medical supplier is just a phone call away. See cover for full details

Prices shown are exclusive of VAT and delivery

S1 Practice Wall Stations Otosscopes & Ophthalmoscopes



S1 Practice Twin Handle Wall Station with Tip Dispenser

Includes:

- S1 Practice F.O. Otoscope
- L28 Practice Ophthalmoscope
- Tip Dispenser

100.030.010/1 **£475.00**
S1 LED Wall Mounted Diagnostic Centre with Tips Dispenser

100.000.142 **£199.00**
Mobile Trolley Mount with mounting plate



S1 Practice Twin Handle Wall Station with Tip Dispenser and Thermometer Holder

Includes:

- S1 Practice F.O. Otoscope
- L28 Practice Ophthalmoscope
- Tip Dispenser
- I.R. Thermometer Holder

100.030.010/2 **£504.00**
S1 LED Wall Mounted Diagnostic Centre with Tips Dispenser and IR Thermometer bay

100.000.142 **£199.00**
Mobile Trolley Mount with mounting plate



S1 Practice Twin Handle Wall Station with Tip Dispenser

Includes:

- S1 Practice F.O. Otoscope
- L28 Practice Ophthalmoscope
- Tip Dispenser
- I.R. Thermometer Holder
- BoSo Large Dial Sphyg

100.030.010/3 **£603.00**
S1 LED Wall Mounted Diagnostic Centre with Tips Dispenser, IR Thermometer bay and Sphyg

Your local medical supplier is just a phone call away. See cover for full details

Prices shown are exclusive of VAT and delivery

Otosscopes & Ophthalmoscopes **EENT Diagnostic Sets**

OPTICLAR VISIONMED EENT Diagnostic Sets

The Opticlar S1 EENT sets provide ENT professionals with the diagnostic capabilities they require in a high quality yet affordable format featuring simple, functional design and elegant detailing.

See pages 17-19 for full product description and page 41 for ENT accessories.

EENT Sets Include:

- S1 Practice F.O. Otoscope
- L28 Practice Ophthalmoscope
- Curved laryngeal mirror
- Tongue blade holder and illuminator
- Nasal illuminator
- Bi-Valve Nasal Speculum
- Choice of Power Supply Systems



100.020.030



Practice EENT Set – Battery Handle



100.020.030 £745.00
EENT Diagnostic Set - Adapt C Cell Battery handle

VisionMed Practice instruments include TrueTone LED illumination, the standard providing the brightest view, finest colour rendering and natural tone. LED guaranteed for 10 years

Practice EENT Set – USB Rechargeable Handle



100.020.031



100.020.031 £790.00
EENT Diagnostic Set - Adapt USB Rechargeable handle

Your local medical supplier is just a phone call away. See cover for full details
Prices shown are exclusive of VAT and delivery

EENT Diagnostic Sets Oscopes & Ophthalmoscopes

Practice EENT Set – Adapt Desk Rechargeable

100.020.032 **£860.00**

S1 EENT Diagnostic Set - 1 x Adapt Lithium Rechargeable Handle, Single Port Charger

100.020.033 **£995.00**

S1 EENT Diagnostic Set - 2 x Adapt Lithium Rechargeable Handles, Twin Port Charger

100.020.032



VisionMed Practice instruments include TrueTone LED illumination, the standard providing the brightest view, finest colour rendering and natural tone. LED guaranteed for 10 years



100.025.031

Practice EENT Set – E-Lithium Desk Rechargeable

100.025.030



100.025.030 **£825.00**

S1 EENT Diagnostic Set - 1 x E-Lithium Rechargeable Handle, Single Port Charger

100.025.031 **£935.00**

S1 EENT Diagnostic Set - 2 x E-Lithium Rechargeable Handles, Twin Port Charger

Your local medical supplier is just a phone call away. See cover for full details

Prices shown are exclusive of VAT and delivery

Otosopes & Ophthalmoscopes Specialist Ophthalmic Instruments

OPTICLAR AL68 Ophthalmoscope

- Fully featured ophthalmoscope for specialist use
- True-Tone LED illumination
- Superior miniaturised optics facilitates entry into even very small diameter pupils
- Polarising filter practically eliminates corneal reflex and can be used on all apertures
- Sealed optics for long life and reduced running costs
- 68 lenses from -30 to +38 in single steps
- Independently selectable red free filter for use on all apertures provides increased contrast
- 18 filter/aperture combinations for increased diagnostic capabilities
- Cobalt blue filter to help detect corneal abrasions
- Selectable apertures - Micro Spot, small spot, large spot, fixation star, slit, cobalt blue, red free on all apertures
- Polarising on all above except for red free and cobalt blue
- Battery life: C cell - 125 hours continuous use, rechargeable Lithium Ion - 2 hours continuous use from full charge



Apertures



Lens range -30 to +38 full range in single diopter steps



OPTICLAR Streak Retinoscope

- True-Tone LED illumination
- Excellent fundus reflex from exceptional clear LED light
- Dustproof for reduced maintenance and downtime
- Single adjustment wheel for easy control of slit rotation and convergence/divergence
- Integral soft brow rest increases comfort and protects examiners spectacles
- Superior construction for longevity and reliability
- Magnetic Fixation cards supplied as standard



VisionMed Practice instruments include TrueTone LED illumination, the standard providing the brightest view, finest colour rendering and natural tone. LED guaranteed for 10 years

Your local medical supplier is just a phone call away. See cover for full details

Prices shown are exclusive of VAT and delivery

Specialist Ophthalmoscopes Otoscopes & Ophthalmoscopes

OPTICLAR AL68 Ophthalmoscope Sets



125 hours continuous use 2 x C Cell Adapt battery handle



100.020.060

100.020.060 **£308.00**
AL68 LED Ophthalmoscope Set with Adapt C Cell Battery Handle

20 hours continuous use
USB rechargeable Adapt battery handle



100.020.061 **£364.00**
AL68 LED Ophthalmic Set with USB Handle

100.000.123/71 **£9.99**
USB recharger to fit 3 pin UK plug

100.000.123/72 **£12.99**
USB recharger to fit car accessory socket



100.020.062 **£444.00**
AL68 LED Ophthalmoscope Set. Adapt Lithium rechargeable Handle and Single Port Charger



100.025.060



100.025.060 **£394.00**
AL68 LED Ophthalmoscope Set. E-Lithium Rechargeable Handle Single Port Charger

AL68 Single wall unit

- Supplied with one handle
- 12ft/ 3.65metre cable
- AL68 ophthalmoscope lockable head
- Mains operated

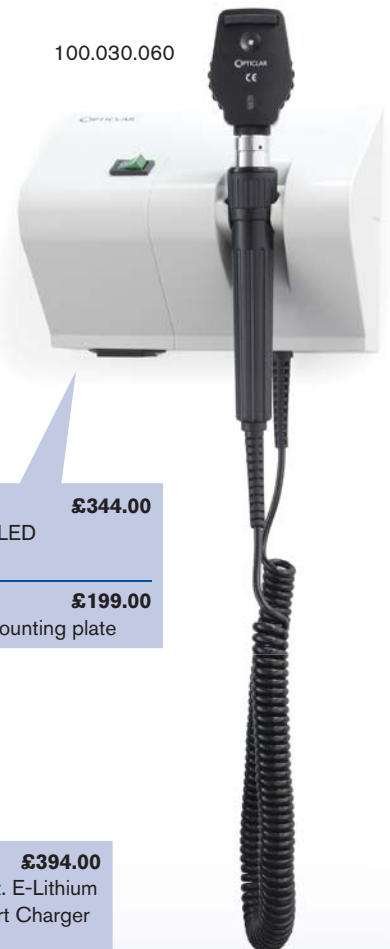

100.030.060

100.030.060 **£344.00**
AL68 Wall Mounted Single LED Ophthalmic Set

100.000.141 **£199.00**
Mobile Trolley Mount with mounting plate

Your local medical supplier is just a phone call away. See cover for full details
Prices shown are exclusive of VAT and delivery

Otosopes & Ophthalmoscopes Retinoscopes

OPTICLAR Streak Retinoscope Sets



125 hours continuous use
2 x C Cell Adapt Battery Handle

100.020.080 **£289.00**
Streak Retinoscope Set - Adapt C Cell Battery Handle



20 hours continuous use
USB Rechargeable Adapt Battery Handle

100.020.081 **£340.00**
Streak Retinoscope Set - Adapt USB Lithium Ion rechargeable battery handle

100.000.123/71 **£9.99**
USB recharger to fit 3 pin UK plug

100.000.123/72 **£12.99**
USB recharger to fit car accessory socket



100.020.082 **£399.00**
Streak Retinoscope with Adapt Rechargeable Lithium Ion Handle, Single Port Charger



Single wall unit includes:

- Mains powered wall unit with corded handle and lockable collar
- 12ft/ 3.65metre cable
- Streak Retinoscope head

100.030.080 **£325.00**
Wall mounted Streak Retinoscope with Corded Handle

100.000.141 **£199.00**
Mobile Trolley Mount with mounting plate



100.025.080 **£364.00**
Streak Retinoscope with E - Lithium Ion Handle, Single Port Charger

Your local medical supplier is just a phone call away. See cover for full details
Prices shown are exclusive of VAT and delivery

Specialist Ophthalmic Sets Oscopes & Ophthalmoscopes

OPTICLAR AL68 Ophthalmoscope & Retinoscope Ophthalmic Sets Refer to page 30 for full product description



VisionMed Practice instruments include TrueTone LED illumination, the standard providing the brightest view, finest colour rendering and natural tone. LED guaranteed for 10 years

Specialist Ophthalmic Set with Battery Handles

- Includes:
- Streak Retinoscope
 - AL68 Specialist Ophthalmoscope
 - 2 x Battery Handles
 - Zip Case

100.020.130 **£575.00**
Ophthalmic Set - Battery Handle

Specialist Ophthalmic Set with USB Rechargeable Handles



- Includes:
- Streak Retinoscope
 - AL68 Specialist Ophthalmoscope
 - 2 x Adapt USB Rechargeable Handles
 - Zip Case

100.020.131 **£689.00**
Ophthalmic Set - Adapt USB Lithium Ion rechargeable battery handle

100.000.123/71 **£9.99**
USB recharger to fit 3 pin UK plug

100.000.123/72 **£12.99**
USB recharger to fit car accessory socket

Your local medical supplier is just a phone call away. See cover for full details
Prices shown are exclusive of VAT and delivery

Otosopes & Ophthalmoscopes **Specialist Ophthalmic Sets**

OPTICLAR AL 68 Ophthalmoscope and Retinoscope Combination Sets

Specialist Ophthalmic Set with E-Lithium Rechargeable Handles and Twin Port Charger



Includes:

- AL68 Ophthalmoscope
- Streak Retinoscope
- 2 E-Lithium Rechargeable Handles
- Twin Port Charger
- Zip Case

100.025.130 **£689.00**
Ophthalmic Set with 2 E-Lithium Ion Rechargeable Handles, Twin Port Charger

VisionMed Practice instruments include TrueTone LED illumination, the standard providing the brightest view, finest colour rendering and natural tone. LED guaranteed for 10 years

AL 68 Ophthalmic Set with Adapt Lithium Ion Rechargeable Handles and Twin Port Charger

Includes:

- AL68 Ophthalmoscope
- Streak Retinoscope
- 2 Adapt Lithium Rechargeable Handles
- Twin Port Charger
- Zip Case



Twin Bay Wall Station includes:

- Mains wall unit with 2 x corded handles with lockable collars
- 12ft/ 3.65metre cable
- AL68 Ophthalmoscope and Streak retinoscope heads

100.030.130 **£611.00**
Wall mounted Ophthalmic Set with twin Handles

100.000.141 **£199.00**
Mobile trolley mount for Wall Unit with mounting plate

100.020.132 **£750.00**
Ophthalmic Set with 2 x Adapt metal Lithium Ion Rechargeable Handles, Twin Port Charger

Your local medical supplier is just a phone call away. See cover for full details

Prices shown are exclusive of VAT and delivery



Tips and Dispensers Otosscopes & Ophthalmoscopes

OPTICLAR Disposable Specula



All Opticlar disposable single patient ear tips are manufactured to the highest possible standards. For those surgeries using a mix of equipment we have designed the OPTICLAR tip fitment to be compatible with other well known brands.

Our tips are available in 2 variations:



Opticlar H Range Tips

For Opticlar pocket instruments P1 Mini Plus, P2 Mini Pro and P3 K-Scope. Compatible with German Brand pocket otoscopes and full-size fibre optic otoscopes. Available in 2.5mm, 4mm and 5mm (nasal) sizes.

Opticlar W Range Tips

For Opticlar S1 Practice Fibre Optic Otoscope. In addition they are also compatible with American Brand fibre optic otoscopes. Available in 2.75mm and 4.25mm sizes.



			50	100	250	500	1000	5000	10000
Opticlar H Range Tips	100.250.000	2.5mm dia tips	£8.00	£11.00	£18.00	£32.00	£54.00	£239.00	£435.00
	100.400.000	4.0mm dia tips	£8.00	£11.00	£18.00	£32.00	£54.00	£239.00	£435.00
	100.500.000	5.0mm dia tips	£10.00	£14.00					
Opticlar W Range Tips	100.275.000	2.75mm dia tips	£8.00	£11.00	£18.00	£32.00	£54.00	£239.00	£435.00
	100.425.000	4.25mm dia tips	£8.00	£11.00	£18.00	£32.00	£54.00	£239.00	£435.00

OPTICLAR Disposable Specula Dispensers

Accessory box and tip dispenser



100.000.130/5 **£34.00**

Tip dispenser with twin mini instrument ports



100.000.130/6 **£42.00**

Tip dispenser with single mini instrument port



100.000.130/7 **£42.00**

Auxiliary Side Holster

- For use with Tip Dispensers
- Holds disposable noots tanks or plastic accessory cup (1 x included)



100.000.130/8 **£32.00**

OPTICLAR tip dispensers are a cost effective way of managing your disposable tips and come complete with 4 dispensing tubes and instrument compartment with lid

- Uniquely each tube dispenser can be labelled with the diameter of the tip it dispenses so ensuring the correct diameter tip is selected.
- Suitable for use with OPTICLAR, Heine, Riester, KaWe and Keeler Jazz disposable tips.

Let us know which type of tips you are using and we will add reorder codes to your dispenser ensuring you always order the correct item.



Your local medical supplier is just a phone call away. See cover for full details

Prices shown are exclusive of VAT and delivery

Otosscopes & Ophthalmoscopes Power Supplies

OPTICLAR Wall Units



OPTICLAR VISIONMED wall units meet all national and international standards and are CE marked for peace of mind.

- Each unit has been designed without flat surfaces which can attract unwanted items such as used tips etc.
- Handles have Auto on/off and spiral cords that have a reach of approx. 12ft/ 3.65mtr
- Heads can be locked into position preventing unauthorised removal
- Wall units can be used as a direct replacement for other leading makes either directly or by use of simple adaptors
- Can be supplied with mobile trolley unit for maximum portability.

OPTICLAR Wall Stations only – Heads not included

100.030.000 Single Bay Wall Unit	£135.00
100.030.001 Extension module for Single Bay Wall Unit	£85.00
100.030.002 Twin Bay Wall Unit	£199.00
100.000.141 Mobile Trolley for Single Wall Units with mounting plate	£199.00
100.000.142 Mobile Trolley for Twin Bay Wall Units with mounting plate	£199.00

100.030.006 Hand disinfectant dispenser with trolley mount	£230.65
166-0-121 BoSo Nova Large Dial Aneroid Syphyg for trolley mount with integral cuff holder	£99.00
100.030.007 Basket for additional cuffs for BoSo Nova Aneroid	£123.50
100.000.130/9 IR Thermometer Holder Bay	£29.00
100.030.008 Glove Box Holder for Trolley	£116.35
100.030.009 Waste receptacle	£129.60

Your local medical supplier is just a phone call away. See cover for full details

Prices shown are exclusive of VAT and delivery



All OPTICLAR Pocket and Pocket Plus handles are fully compatible with German brand ranges of screw thread instruments.



OPTICLAR Power Sources - Mini Handles

- Available in either P2 Slimline and P3 Wide Line version
- Feature a metal screw thread connector for reliability and longevity
- Convenient pocket clips
- Fully tested on/off switches

Pocket P2 Slimline & P3 Wideline Handles

- Double ended enabling insertion of batteries without removing instrument head
- When used with Alkaline AA batteries and OPTICLAR LED instrument heads battery life is > 100 hours continuous use.

Pocket Plus Metal Handles

- Rotary on/ off switch if used with LEDs or rheostat if used with halogen or xenon instruments
- Fully compatible with German brand screw thread pocket instruments

100.010.000/10 OPTICLAR P2 Pocket handle - slimline black	£16.50
100.010.000/13 OPTICLAR P2 Lithium ion rechargeable handle	£49.50
100.012.000/11 OPTICLAR P3 Pocket handle - K-Scope black/blue/white	£49.50
100.015.000/10 OPTICLAR P1 Pocket Plus handle - metal	£49.50



OPTICLAR Power Sources - Battery and Rechargeable Handles

ADAPT handles are modular allowing users to start with C cell sets and add rechargeable cells and chargers at a later date. Opticlar E-Lithium handles are a compact, lightweight and affordable alternative for use with single and twin pod chargers. Due to the unique OPTICLAR MultiVoltage System our instrument heads can be interchanged between different power systems with no modifications necessary and with no concern over blowing bulbs or inadequate illumination.

- **Adapt System:** Choice of C Cell handle, lithium Ion rechargeable handle with USB charging base or rechargeable handle with desk charging single or twin pod
- **E-Lithium System:** lithium Ion rechargeable handle for use with desk charging single or twin pod
- Initial charge 120 minutes (12 hours via USB)
- Battery life continuous use:
 - Adapt C Cell - 125 hours
 - Adapt USB and rechargeable - 20 hours
 - E-Lithium rechargeable - 10 hours

OPTICLAR ADAPT

- C Cell
- USB
- Desktop Charger



100.020.000/2

OPTICLAR E - Lithium

- Desktop Charger



100.025.000/1

100.020.000/1 OPTICLAR ADAPT Battery handle, 2 C Cell	£87.50
100.020.000/2 OPTICLAR ADAPT USB rechargeable handle, Lithium	£139.50
100.020.000/3 OPTICLAR ADAPT Lithium rechargeable handle for pod chargers	£106.00
100.025.000/1 OPTICLAR E-Lithium rechargeable handle	£79.00

Your local medical supplier is just a phone call away. See cover for full details

Prices shown are exclusive of VAT and delivery

Otosscopes & Ophthalmoscopes Power Supplies

OPTICLAR Recharging Pods

All OPTICLAR VISIONMED recharging pods meet national and international standards and are CE marked for peace of mind. Most sets are offered with our space efficient single port pod however where appropriate the slightly larger twin port pod is offered.

- All pods are supplied with 3 pin UK plugs and other configurations are available upon request
- All transformers plug into the rear of the pod so in the event of breakage or malfunction only the transformer has to be returned or replaced
- This greatly simplifies repairs and enables users to swap components without the cost and inconvenience of returning the complete charging base
- Realising that the most convenient position for our charging pod may not be close to a mains plug we equip our transformers with a generous 10ft lead.



100.010.123/2 OPTICLAR VISIONMED Mini Single Port Charging Pod	£68.75
100.010.123/1 OPTICLAR VISIONMED Mini Twin Port Charging Pod	£88.75



100.000.123/2 OPTICLAR VISIONMED Single Port Charging Pod	£98.50
100.000.123/1 OPTICLAR VISIONMED Twin Port Charging Pod	£139.00



Lithium Ion Cells

We only offer the highest quality lithium ion rechargeable cells that provide quicker recharge times, longer use time and lighter weight than NIMh systems with the added bonus of no memory effect. Initial charge time depends upon handle fitment, however operating time is circa 20 hours

100.000.123/10 Lithium Ion re-chargeable cells	£49.00
--	---------------

Your local medical supplier is just a phone call away. See cover for full details
Prices shown are exclusive of VAT and delivery

OPTICLAR VISION^{LED}MED

P3 LED DI
Otoscope
head



P3 LED FO
Otoscope
head



P2 Truetone
LED FO
Otoscope
head



'Opticlar VISION instrument heads are available to purchase separately on the following pages. Please refer to the full product page for further information and specifications. Don't forget that Opticlar VisionMed instruments can be supplied compatible with other brands from the USA and Germany, saving you £££'s when upgrading an existing set. Please call for details.



All OPTICLAR VISION instruments are manufactured to exacting standards and meet or exceed national and international standards and are marked accordingly.

- Standard warranty terms 2 years with an additional 3 years warranty added free of charge upon return of our warranty registration card
- OPTICLAR MV LED Bulbs 10 years total warranty
- In the unlikely event of failure please return the item to ourselves for repair or replacement

- Our warranty covers faulty workmanship and materials but does not cover misuse or accidental damage

OPTICLAR VISIONMED Pocket Otoscope Heads

- Pocket Otoscope have a metal screw thread connector for reliability and longevity
- Fully compatible with premium German brand handles and are cost effective replacements for old or damaged equipment or as an upgrade to LED illumination

100.000.023DI **£42.00**
P3 LED DI Otoscope head. Available in Black, Blue or White, please state when ordering

100.000.023FO **£49.00**
P3 Otoscope head. Available in Black, Blue or White, please state when ordering

100.000.022 **£54.00**
P2 LED F.O. Otoscope head

100.000.019 **£3.20**
Insufflation port adaptor to connect insufflation bellows

100.000.020 **£8.50**
Insufflation bellows

VisionMed Mini Pro LED Ear Light

- TrueTone LED illumination
- Single patient use ear illuminators, screw in fit (10 included)
- Slim line pocket handle with on/off switch
- Takes 2 x AA batteries (included)

100.010.052 **£52.00**

100.010.050/10 **£13.00**

Pack 10 screw-in ear illuminators



VisionMed Mini Pro LED Pocket Torch

- TrueTone LED illumination
- Slim line pocket handle with on/off switch
- Takes 2 x AA batteries (included)

100.010.050 **£43.00**

VisionMed Mini Pro LED Multi Torch

- TrueTone LED illumination
- Incorporates torch with tongue-blade holder
- Slim line pocket handle with on/off switch
- Takes 2 x AA batteries (included)

100.010.054 **£43.00**

100.010.054/1 **£14.60**

Pack 10 acrylic tongue blades



Your local medical supplier is just a phone call away. See cover for full details

Prices shown are exclusive of VAT and delivery

Otosopes & Ophthalmoscopes ENT Instruments

VisionMed Practice ENT Instrument Heads

*American style tip fitment as standard.
Please specify German style tip fitment if required.*

OPTICLAR VISIONMED Standard Size Otoscopes and ENT instruments

- Opticlar VisionMed Practice instruments are full-sized and come with the Opticlar handle fitting as standard
- Bayonet connector fitting also available
- Fitted with Opticlar MultiVoltage illumination enabling them to be moved between C cell handles to rechargeable and Wall based power sources without the need to change bulbs
- Average LED life is greater than 10,000 hours and OPTICLAR MV LEDs are guaranteed for 10 years from date of purchase



VisionMed Practice Fibre Optic Otoscope Head

- TrueTone LED illumination
- FO light transmission
- 3x swivel lens
- Insufflation port

100.000.010 £79.00

OPTICLAR S1 FO LED Standard otoscope head with twist lock

100.000.010H £99.00

OPTICLAR S1 FO LED Standard otoscope head with Auto-lock Bayonet (German brand) connector

Auto-lock (German brand) handle adaptor



VisionMed Practice LED Operating Otoscope Head

- TrueTone LED illumination
- FO light stem
- Open head design, allows procedures to be carried out through the head
- Choice of tip sizes
- Swivelling lens

100.000.012 £99.00

OPTICLAR S2 LED Operating otoscope head

100.000.012H £119.00

OPTICLAR S2 LED Operating otoscope head with Auto-lock (bayonet) connector

100.000.012/2 £4.99

Autoclaveable tip for S2 - 2mm

100.000.012/3 £4.99

Autoclaveable tip for S2 - 3mm

100.000.012/4 £4.99

Autoclaveable tip for S2 - 4mm

100.000.012/5 £4.99

Autoclaveable tip for S2 - 5mm

100.000.012/9 £4.99

Autoclaveable tip for S2 - 9mm

100.000.012/SET £19.99

Set of autoclaveable tips



Your local medical supplier is just a phone call away. See cover for full details

Prices shown are exclusive of VAT and delivery

OPTICLAR Oscope Head Accessories



VisionMed ENT Transilluminator

- Finoff Transilluminator, for scleral transillumination and checking pupil reflex
- LED illumination source
- Also suitable for frontal and maxillary sinus examination



VisionMed Nasal Illuminator

- Fibre optic nasal illuminator, with LED illumination
- Includes nasal speculum
- Suitable for general ENT examinations



100.000.013	Transilluminator	£49.00
100.000.013/H		£71.00
Transilluminator with adaptor to fit Auto-lock handles		

100.000.014	Nasal Illuminator	£79.00
100.000.014/H		£93.00
Nasal Illuminator with adaptor to fit Auto-lock handles		

VisionMed Larynx and Nasopharynx Illuminator

- Fibre Optic light stem
- LED illumination source
- Rotating mirror with pilot hole



VisionMed Bi-Valve Nasal Speculum

- Spreadable speculum for nasal illumination and examination
- LED illumination and fibre optic light stem
- Fingertip control to facilitate the easy removal of foreign bodies



100.000.016	Larynx and Nasopharynx Illuminator	£165.00
100.000.016H		£187.00
Larynx and Nasopharynx Illuminator with adaptor to fit Auto-lock handles		

100.000.015	Bi-Valve Speculum	£86.00
100.000.015/H		£108.00
Bi-Valve Speculum with adaptor to fit Auto-lock handles		
100.000.012/9	Autoclaveable Tip - 9mm	£4.99

VisionMed Multi-Purpose Illuminator

- LED torch with tongue-blade holder
- Takes acrylic tongue blades (available separately)



VisionMed Throat Illuminator with Tongue Blade Holder

- LED illumination and FO light stem
- Holds traditional wooden tongue blades



Insufflation bellows for use with P2 and P3 Oscopes



100.000.017	£37.00
100.000.017H	£59.00
With adaptor to fit Auto-lock handles	
100.010.054/1	£14.60
Pack 10 acrylic tongue blades	

100.000.018	£67.00
100.000.018H	£99.00
With adaptor to fit Auto-lock handles	

100.000.019	£3.20
Insufflation port adaptor	
100.000.020	£8.50
Insufflation bellows	

Your local medical supplier is just a phone call away. See cover for full details
Prices shown are exclusive of VAT and delivery

Otosopes & Ophthalmoscopes **Ophthalmic Instruments**

OPTICLAR VisionMed Ophthalmic Instrument Heads

All Opticlar ophthalmic equipment is manufactured to exacting standards to ensure first class optical performance. **10 Year LED warranty**



OPTICLAR Pocket Ophthalmoscope Head

- Compact ophthalmoscope head for general ophthalmic examinations
- TrueTone LED illumination
- Replacement head for Opticlar VisionMed P1 and P2 sets
- [See page 10 for full product details](#)

100.000.024 £79.99
OPTICLAR Pocket Ophthalmoscope Head



OPTICLAR Standard Size Ophthalmoscopes

- L28 Practice Ophthalmoscope head for general medical examination
- AL68 Specialist Ophthalmoscope head for optometry / ophthalmology
- Double sealed against dust ingress
- TrueTone LED illumination
- [See pages 21 and 30 for full details](#)

L28 Lens range



L28 Apertures



100.000.050 £139.00
L28 Ophthalmoscope Head

100.000.050H £159.00
L28 Ophthalmoscope Head with auto-lock adaptor



L28

AL68 Lens range -30 to +38 full range in single steps



AL68 Apertures



100.000.060 £189.00
AL68 Ophthalmoscope Head

100.000.060H £209.00
AL68 Ophthalmoscope Head with auto-lock adaptor



AL68

Your local medical supplier is just a phone call away. See cover for full details

Prices shown are exclusive of VAT and delivery

OPTICLAR Streak Retinoscope Head

- TrueTone LED multi-voltage illumination, providing the clearest fundus reflex
- Single control for focus and rotation of beam
- Magnetic fixation cards included as standard
- See page 30 for full product details



100.000.080 SR Streak Retinoscope Head	£179.00
100.000.080H SR Streak Retinoscope Head with auto-lock adaptor	£199.00



VisionMed Practice instruments include TrueTone LED illumination, the standard providing the brightest view, finest colour rendering and natural tone. LED Guaranteed for 10 years



Set of 4 Magnetic fixation cards are supplied as standard.

Your local medical supplier is just a phone call away. See cover for full details
Prices shown are exclusive of VAT and delivery

Otosopes & Ophthalmoscopes **Ophthalmic Accessories**

TONO-PEN XL

Applanation Tonometer for Rapid and Accurate Glaucoma screening in the palm of your hand.

Very easy to use, hand held instrument providing fast and accurate intraocular pressure readings with accuracy comparable to the Goldmann Tonometer. The device utilises micro strain gauge technology and a 1.0mm transducer tip. The Tono Pen gently contacts the cornea and displays the average of 4 independent readings along with a statistical co-efficient. Leading EDGE™ recognition software ensures measurements are taken during applanation and ScanLock™ tracking harvests data at a rate of 500 samples per second. Battery powered for complete portability and enough power for 1200 eyes. Ocu-Film™ tip covers are used to reduce the risk of cross contamination



Technical Specifications

Weight	64g (2.2oz)
Dimensions	19cm x 5cm
Transducer	Micro strain gauge
Measurement range	5 - 80mm Hg
Battery	2 Ocu-Cel™ XL batteries

230635	£2100.00
Tono-Pen XL Tonometer Starter Pack with Carry Case, 1 box of Ocu-Film Tip covers. 1 pack of Ocu Cel XL batteries Instructional Video and Manual	

Accessories

230651	£78.00
Ocu-Film Tip covers. Sanitised. Box of 200	
230570	£40.00
Ocu-Cel Batteries. Pack of 4	

Slit-Lamp Model SM-30N

Greenough type microscope with high quality multicoated lens. Two step revolving magnification changer. Light booster mounted on top of joy stick. LED navigation system. Coated reflecting mirror to reduce harmful infrared and UV light emission. Chin rest is stable and durable.



Includes Motorised Table

Specifications

Type	Greenough type stereoscopic microscope
Magnifications	10x, 16x, 25.6x (when 16x eyepieces in use)
Interpupillary adjustment	52mm to 82mm
Slit width	0 to 10mm, continuously variable
Slit length	1 to 10mm, continuously variable
Aperture diaphragms	10mm, 5mm, 3mm, 2mm, 1mm and 0.2mm
Built in filters	Heat absorbing, UV. Red Free and Cobalt Blue
Lamp	12v/30w Halogen bulb
Power consumption	40VA
Base size	359mm x 328.5mm
Weight	13.5Kg

SM-30N	£4750.00
Slit lamp with headrest and transformer on motorised table	

Spring Cell Trial Frame

- Lightweight yet durable plastic construction.
- Spring cells for full aperture lenses
- 24 – 40mm PD each side (48mm to 80mm)
- Soft contoured nasal bridge
- Holds 6 full aperture lens
- Adjustable bridge, side lengths and angles



AWO-TFP Spring Cell Trial Frame - Deluxe Version	£96.75
---	---------------

Trial Lens Set

- This high quality yet economically priced trial lens set is ideal for the new practitioner or for upgrading an existing practice.
- Full aperture lens set comprising 266 pieces
- Glass lenses with metal rims and handles
- Protective carry case with individual compartments
- Convex and concave spherical lenses
- Convex and concave cylinders
- Prism
- Full accessory lens set included



AWO-TLS266	£395.00
266 piece trial lens set complete in leather storage case	

AWO-TLS/TFP	£425.00
Combination 266 piece trial lens set complete in leather storage case with Deluxe Spring Cell trial frame. (Saving £66.00 from individual purchase price)	

Your local medical supplier is just a phone call away. See cover for full details

Prices shown are exclusive of VAT and delivery

Ishihara Tests for Colour Blindness

- Popular and efficient test for red/green colour vision deficiency
- Quickly differentiates between congenital and acquired defects
- Choice of 38 plate, 24 plate and 14 plate editions

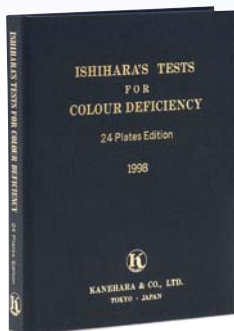

AW226	Ishihara Test, 38 plate edition	£173.00
AW227	Ishihara Test, 24 plate edition	£155.00
AW228	Ishihara Test, 14 plate edition	£112.00

3M and 6M Test Chart



- Double sided chart for adults and children
- 3M version has standard TVH test type on side one, Kindergarten test on side two
- 6M version has AOE test type on side one, Kindergarten test on side two
- Glare reducing surfaces allow the chart to be highly illuminated without reflection
- Washable, wipe-clean surfaces
- 3 or 6 metre viewing distance
- Includes hanging cord

AW340	Test Chart, double sided	£18.00
AW340/6	Test Chart, double sided 6M viewing distance	£28.00

3M Illuminated Test Chart

- Slimline, lightweight and completely portable
- Ideal for domiciliary visits or where wall space is minimal
- Each side has individually switched illumination
- Glare reducing surfaces eliminate annoying reflections
- Fitted with a dual purpose carrying handle/desk stand
- Can be wall mounted
- Individual TVH Snellen Test Type and Kindergarten Test included
- Dimensions 30 x 34cm and ultra-slim to fit most briefcases
- Weight 1.8 kg



AW363	3M Illuminated Test Chart	£345.00
--------------	---------------------------	----------------

6M Test Chart

- 6 metre TVH test type on side one
- Illiterate 'E' test on reverse
- Patient hand card also included, with near vision test on reverse
- Double sided and laminated for durability
- Washable, wipe-clean surfaces
- Can be viewed direct or indirect (via mirror)
- Includes hanging cord



AW341	Test Type with patient hand card	£28.00
--------------	----------------------------------	---------------

AW Eye Test Charts

Reading Test Type No.300

- Traditional reading test type, double sided
- Faculty approved N5 to N48
- Includes news print, Snellen chart reduced for near vision, and music
- Printed back to back and laminated
- Washable and hard wearing

AW300	Reading Test Type	£16.00
--------------	-------------------	---------------

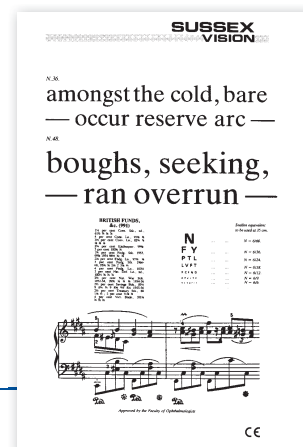

Reading Test Type No.301

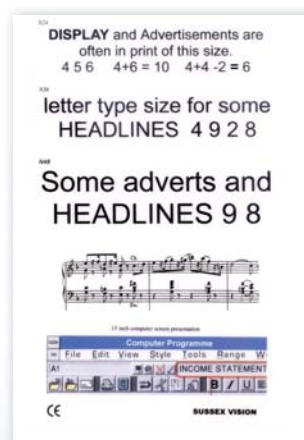

- A modern version of the traditional type 300 test
- Type face is Arial instead of Times Roman
- Text begins with larger print size and progresses to smaller sizes
- Largest text has been separated and put on reverse for LVA patients
- Numerals have been introduced to assist with non-english readers and illiterates
- A section of typical computer presentation has also been introduced
- Printed back to back and laminated
- Washable and hard wearing

AW301	Reading Test Type, modern	£16.00
--------------	---------------------------	---------------

Your local medical supplier is just a phone call away. See cover for full details

Prices shown are exclusive of VAT and delivery



The 2G Range was introduced into the UK in 2000 and has since become one of the leading sources of generic medical, surgical and veterinary products, earning popularity with Practitioners, Practice Managers and NHS institutions who recognise the outstanding quality and cost savings that the 2G range offers.

Behind the 2G lies a wealth of knowledge and expertise drawn from 50 years experience selling and servicing hand held diagnostic equipment throughout the UK and Ireland. This results in 2G offering superb quality and performance at extremely competitive prices.

Continually growing 2G now includes not only consumables but replacement spares for manufacturers such as Welch Allyn, Heine, Keeler, Riester and KaWe.

New to the 2G range are LED upgrade kits enabling users to improve the performance of their favourite diagnostic tools to a modern, efficient LED illumination.

Designed and engineered for reliability and durability 2G products feature an attractive 2 year warranty as standard (where applicable). LED upgrades are guaranteed for 10 years.



2G Guardian Generica Disposable Specula for HEINE Direct Illumination Otoscopes

- Fits HEINE K100 and BETA100 direct illumination otoscopes
- Superb fit with atraumatic distal end
- Black colour minimizes light loss



2.5mm Tips

HSD12.5/50	Pack of 50	2.5mm diameter	£8.00
HSD12.5/100	Pack of 100	2.5mm diameter	£11.00
HSD12.5/250	Pack of 250	2.5mm diameter	£18.00
HSD12.5/500	Pack of 500	2.5mm diameter	£34.00
HSD12.5/1000	Pack of 1000	2.5mm diameter	£63.00

4.0mm Tips

HSD14.0/50	Pack of 50	4mm diameter	£8.00
HSD14.0/100	Pack of 100	4mm diameter	£11.00
HSD14.0/250	Pack of 250	4mm diameter	£18.00
HSD14.0/500	Pack of 500	4mm diameter	£34.00
HSD14.0/1000	Pack of 1000	4mm diameter	£63.00

Your local medical supplier is just a phone call away. See cover for full details

Prices shown are exclusive of VAT and delivery

GG Specula Spares & Accessories Otoroscopes & Ophthalmoscopes

2G Guardian Generica Disposable Specula for HEINE Fibre Optic Otoroscopes

- Fits all HEINE mini, K180 and BETA fibre optic otoroscopes
- Superb fit with atraumatic distal end

2.5mm Tips

HSFO2.5/50	Pack of 50	2.5mm diameter	£8.00
HSFO2.5/100	Pack of 100	2.5mm diameter	£11.00
HSFO2.5/250	Pack of 250	2.5mm diameter	£18.00
HSFO2.5/500	Pack of 500	2.5mm diameter	£32.00
HSFO2.5/1000	Pack of 1000	2.5mm diameter	£54.00

4.0mm Tips

HSFO4.0/50	Pack of 50	4mm diameter	£8.00
HSFO4.0/100	Pack of 100	4mm diameter	£11.00
HSFO4.0/250	Pack of 250	4mm diameter	£18.00
HSFO4.0/500	Pack of 500	4mm diameter	£32.00
HSFO4.0/1000	Pack of 1000	4mm diameter	£54.00



2G Guardian Generica Disposable Specula for Keeler Otoroscopes

- High quality disposable specula to fit the Practitioner, Standard, Pocket, Vista, Fibre Optic and Medic Otoroscopes
- 2.5mm, 3.5mm, 4.5mm and 5.5mm end diameters

2.5mm Tips

KS2.5	Pack of 25	2.5mm diameter	£4.00
KS2.5/100	Pack of 100	2.5mm diameter	£12.00
KS2.5/500	Pack of 500	2.5mm diameter	£44.00

3.5mm Tips

KS3.5	Pack of 25	3.5mm diameter	£4.00
KS3.5/100	Pack of 100	3.5mm diameter	£12.00
KS3.5/500	Pack of 500	3.5mm diameter	£44.00

4.5mm Tips

KS4.5	Pack of 25	4.5mm diameter	£4.00
KS4.5/100	Pack of 100	4.5mm diameter	£12.00
KS4.5/500	Pack of 500	4.5mm diameter	£44.00

5.5mm Tips

KS5.5	Pack of 25	5.5mm diameter	£4.00
KS5.5/100	Pack of 100	5.5mm diameter	£12.00
KS5.5/500	Pack of 500	5.5mm diameter	£44.00



Your local medical supplier is just a phone call away. See cover for full details
Prices shown are exclusive of VAT and delivery

Otosopes & Ophthalmoscopes **GG Specula Spares & Accessories**

2G Guardian Generica Disposable Specula for Welch Allyn Otoscopes

- Fits all Welch Allyn otoscopes except the Macroview
- Very high quality atraumatic tips

2.75mm Tips

WS2.75	Pack of 25	2.75mm diameter	£3.00
WS2.75/100	Pack of 100	2.75mm diameter	£11.00
WS2.75/500	Pack of 500	2.75mm diameter	£32.00
WS2.75/1000	Pack of 1000	2.75mm diameter	£54.00

4.25mm Tips

WS4.25	Pack of 25	4.25mm diameter	£3.00
WS4.25/100	Pack of 100	4.25mm diameter	£11.00
WS4.25/500	Pack of 500	4.25mm diameter	£32.00
WS4.25/1000	Pack of 1000	4.25mm diameter	£54.00



2G Generic Welch Allyn Reusable Otoscope Tips

- Select the appropriate Guardian Generica tip by cross referring to the correct Welch Allyn reference
- Choice of diameters from 2mm to 9.0mm
- Available in set of tips consisting of one each of 2mm, 3mm, 4mm, 5mm and 9mm diameters

WA ref	2G ref	Diameter	Price
22002	100.000.012/2	2.0mm diameter	£4.99
22003	100.000.012/3	3.0mm diameter	£4.99
22004	100.000.012/4	4.0mm diameter	£4.99
22005	100.000.012/5	5.0mm diameter	£4.99
22009	100.000.012/9	9.0mm diameter	£4.99
22100	100.000.012/SET	Set of Above 5 tips	£19.99

Your local medical supplier is just a phone call away. See cover for full details

Prices shown are exclusive of VAT and delivery

GG Specula Spares & Accessories Otosscopes & Ophthalmoscopes



Guardian Generica Kawe Disposable Specula

- Fits all Kawe mini and fibre optic otoscopes
- 2.5 mm and 4mm end diameters

KWS 2.5/250	Pack of 250	2.5mm diameter	£12.00
KWS 4.0/250	Pack of 250	4mm diameter	£12.00

Guardian Generica Riester Disposable Specula

- Fits all Riester mini and fibre optic otoscopes
- 2.5 mm and 4mm end diameters

RS 2.5/250	Pack of 250	2.5mm diameter	£17.00
RS 4.0/250	Pack of 250	4mm diameter	£17.00

Rechargeable Cells suitable for use with Heine or Welch Allyn handles

A range of quality rechargeable cells, guaranteed for 2 years with an average working life of 5 years



HEINE Ref. X-002.99.382

3.5v rechargeable handle NiMh rechargeable battery to fit Beta rechargeable handles and F.O. laryngoscope handles

HRC382

£43.50

WA ref	2G ref	Diameter	Price
72000	WA720002G	2.5v 600mAh NiCad Red label	£38.00
72200	WA722002G	3.5v 600mAh NiCad Black label	£38.00
72300	WA723002G	3.5v 800mAh NiCad Orange label	£38.00
72600	WA726002G	2.5v 600mAh NiCad Blue label	£38.00

Your local medical supplier is just a phone call away. See cover for full details

Prices shown are exclusive of VAT and delivery

Otosscopes & Ophthalmoscopes GG Specula Spares & Accessories



Results of using LED

- Superior illumination
- Longer battery life
- Less charge time
- Reduced ongoing costs of bulb replacements
- Fantastic 10 year warranty against bulb failure



2G Guardian Generica Bulbs

- Compatible with Heine, Welch Allyn, Kawe Keeler or Riester instruments
- Low cost option for replacing bulbs
- Upgrade to LED when replacing halogen for superior illumination
- 10 year warranty on LED upgrade bulbs
- Choice of standard or premium multi-voltage LED bulbs that can be used with a variety of power sources - standard C cell batteries, rechargeable battery handle or mains powered wall units

2G HEINE Bulbs

- HEINE instruments take either 2.5v or 3.5v bulbs. A common error is the fitting of the incorrect voltage bulb resulting in immediate bulb failure (2.5v fitted to 3.5v handle or wall unit) or dim illumination (3.5v bulb fitted to C cell battery handle). To ensure you order the correct voltage bulb use this simple decision tree:
- Which bulb do you need?
- If the power source is a C cell battery handle i.e. replaceable batteries you need a 2.5v bulb
- If the power source is rechargeable or wall unit you need s 3.5v bulb

If you are unsure please contact us and we will identify the bulb voltage you require.

LED Upgrade Kit

With a 2G LED upgrade kit you can avoid the problem of which bulb to use. We have specially designed our LED kits to be multi-voltage so they are perfectly suitable for use with 2.5v or 3.5v power sources. LED bulbs are **guaranteed for 10 years**. The extra cost for the 2G LED upgrade is easily recouped after a few months through increased battery usage and shorter recharge times. The main benefit of the 2G LED upgrade is significantly brighter illumination and no need to purchase a new head.

Heine ref	2G Xenon Bulb	Price	Multi-voltage LED upgrade	Price
X-001.88.035	H035	£14.00	H035044	£28.00
X-001.88.037	H037	£14.00	H037049	£28.00
X-001.88.038	H038	£14.00		
X-001.88.039	H039	£14.00		
X-001.88.040	H040	£14.00		
X-001.88.041	H041	£14.00	H000041	£28.00
X-001.88.042	H042	£14.00		
X-001.88.056	H110056	£14.00	H056110	£28.00
X-001.88.057	H057	£14.00		
X-001.88.059	H059	£14.00		
X-001.88.069	H069	£14.00		
X-001.88.077	H077	£14.00	H077078	£28.00
X-001.88.084	H084	£14.00		
X-001.88.087	H087	£14.00		
X-001.88.105	H105	£14.00	H000105	£28.00
X-001.88.106	H106	£14.00		
X-001.88.107	H107	£14.00	H000107	£28.00
X-001.88.109	H109	£14.00		
X-001.88.110	H110056	£14.00	H056110	£28.00
X-002.88.044	H044	£14.00	H035044	£28.00
X-002.88.046	H046	£14.00		
X-002.88.049	H049	£14.00	H037049	£28.00
X-002.88.070	H070	£14.00		
X-002.88.078	H078	£14.00	H077078	£28.00
X-002.88.086	H086	£14.00		
X-002.88.091	H091	£14.00		
X-002.88.101	H101	£14.00		
X-004.88.068	H068	£14.00		

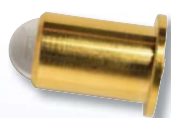

H087

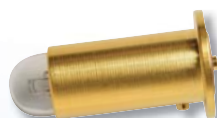

H068

Your local medical supplier is just a phone call away. See cover for full details

Prices shown are exclusive of VAT and delivery

GG Specula Spares & Accessories Oscopes & Ophthalmoscopes

Why 2G LED

On average Xenon halogen bulbs have a useful working life of approximately 25 hours continuous use, however the quality of illumination degrades from new. Battery life with Xenon halogen bulbs is approximately 4 hours for C cells and 1 hour for NiMh cells.

With 2G LED bulbs the illumination is the same throughout the life of the bulb, in excess of 10,000 hours use. Battery life is greater than 100 hours with C cells and 20 hours for rechargeable NiMh cells

Why 2G Xenon Bulbs

2G Xenon bulbs are manufactured by a world leading miniaturised bulb company and provide high quality illumination suitable for all examinations. We are confident you will be entirely satisfied with your choice of 2G Xenon bulb.

Spare Bulbs for Keeler Ophthalmoscopes and Oscopes



Ophthalmoscope

KT12.8	2.8v halogen bulb for Keeler pocket ophthalmoscope. Single packed	£21.00
KT22.8	2.8v halogen bulb for Keeler New Standard and New Practitioner ophthalmoscope	£21.00
KT23.6	3.6v halogen bulb for Keeler New Standard and New Practitioner ophthalmoscope	£21.00
KT32.8	2.8v halogen bulb for Keeler Vista and Vista 20 ophthalmoscope	£21.00
KT33.6	3.6v halogen bulb for Keeler Vista and Vista 20 ophthalmoscope	£21.00

Otoscope bulb – screw in type

KT42.8	2.8v halogen bulb for Keeler Standard, Pocket Deluxe, Vetscope and Tongue depressor	£21.00
KT43.6	3.6v halogen bulb for Keeler Standard, Pocket Deluxe, Vetscope and Tongue depressor	£21.00

Otoscope bulb – push in type

KT52.8	2.8v halogen bulb for Keeler Practitioner, Vista, Fibre Optic Oscope and Finoff transilluminator	£21.00
KT53.6	3.6v halogen bulb for Keeler Practitioner, Vista, Fibre Optic Oscope and Finoff transilluminator	£21.00

Generic Spare bulbs for Welch Allyn Instruments

WA Ref No.	Description	2G Ref No.	List price ex VAT
00200-U	2.7v Vacuum bulb for 4100,26030, 235, 20100, 21600 heads	00200-2G	£6.00
01200-U	Binocular indirect bulb. 4.6v for 125 series indirects	01200-2G	£29.95
02100-U	2.7v vacuum bulb	02100-2G	£15.50
02300-U	2.7v vacuum bulb	02300-2G	£15.50
03000-U	Halogen 3.5v bulb for 11710,12400,47300,11600,11605,11610,18000 instrument heads	03000-2G	£16.25
03100-U	Halogen 3.5v bulb for 25020, 21700, 20200, 73500, 28100, 27000, 27050, 26530, 41100, 43300, 25000, 25200, 20000 heads	03100-2G	£14.40
03300-U	2.5v halogen bulb for 11511,11500 heads	03300-2G	£17.00
03400-U	2.5v halogen bulb for 24011, 24020, 24000, 21110, 21111, 24031, 73550, 27200, 27250, 41110 heads	03400-2G	£15.60
03600-U	2.5v bulb for 60500	03600-2G	£10.95
03800-U	3.5v halogen bulb for 11810, 11820, 11800 heads	03800-2G	£12.95
03900-U	2.5v halogen bulb for 13000,12810 heads	03900-2G	£16.95
04100-U	14.5v bulb for 48400,48410 lights	04100-2G	£78.75
04200-U	12v bulb for 48600,48610,48625,48635,48700 exam lights	04200-2G	£40.90
04400-U	2.5v halogen bulb for 11400,11411,11470,11475 heads	04400-2G	£16.95
04500-U	3.5v halogen bulb for 18010 head	04500-2G	£68.00
04600-U	3.5v halogen bulb for 17710 head	04600-2G	£68.00
04700-U	2.7v vacuum bulb for laryngoscopes	04700-2G	£6.00
04800-U	2.7v vacuum bulb for laryngoscopes	04800-2G	£6.00
04900-U	3.5v halogen bulb for 11720,11730,11735,11620,11630 heads	04900-2G	£17.95
06000-U	2.5v halogen bulb for laryngoscope handles	06000-2G	£15.95
06200-U	3.5v halogen bulb for 23300,23000,23020,23040 heads	06200-2G	£17.75
06500-U	3.5v halogen bulb for 23300,23000,23020,23040 heads	06500-2G	£17.75
07800-U	6.0v halogen bulb for 73211 handle	07800-2G	£23.75
08200-U	3.5v halogen bulb for 18245,18200,18235 heads	08200-2G	£11.95
08500-U	3.6v halogen bulb for 20502S,20512S,20512H head lights	08500-2G	£24.95



If you are unable to see the product you require, please call your local distributor. Most other generic Welch Allyn bulbs are available upon request.

Your local medical supplier is just a phone call away. See cover for full details

Prices shown are exclusive of VAT and delivery

Loupes OPTICLAR Loupes

OPTICLAR VISIONMAG Loupes

By the use of modern polymer plastics OPTICLAR loupes combine durability with comfort and lightweight. OPTICLAR VISIONMAG loupes are available in a variety of magnifications and specifications to cater for a wide range of disciplines. They are ideal for General Surgery, Dermatology, ENT, Ophthalmology, Oral and Maxillofacial, Dentistry and Veterinary medicine as well as many other types of uses.

OPTICLAR VISIONMAG Pro-Line I.O Loupes



OPTICLAR VISIONMAG Pro-Line S.O Loupes



OPTICLAR VISIONMAG Pro-Line Superview Loupes



VISIONMAG

LED

All VISIONMAG loupes have the following characteristics

- Achromatic, multi coated optics for crisp, bright images
- Water resistant
- Independently adjustable optics for perfect PD adjustment or auto adjust optics where applicable for ease of use and perfect PD adjustment
- Wide fields of view
- Deep working distances
- Very lightweight for comfort
- Wide choice of working distances and magnifications providing the ideal solution for many applications
- Competitively priced
- Optional cost effective lighting
- Comfortable, lightweight and strong sports style frame
- Click in supplementary frame for individual prescription lenses
- Lens protectors
- Choice of stylish frame colours
- Storage case

As a guideline the following will help you choose your ideal loupe.

- 1 Field of view, the area that is in focus, generally the wider the better as this reduces the amount of sideways head movement
- 2 Working distance - generally this depends upon whether the user is sitting or standing. However for guidance please use the following;

Height

less than 5ft 4in working distance 340mm
5ft 4in to 5ft 9in working distance 420mm
5ft 9in to 6ft 2in working distance 460mm
Above 6ft 2in working distance 500mm

This guideline is for those practitioners standing, if sitting the next lowest working distance should be most suitable.

Please note that these are only guidelines.

- 3 Magnification – the general rule is the least magnification the better. For most applications a 2.5x or 3.0x loupe is ideal. For more demanding applications such as root canal work, microsurgery, vascular surgery, neurosurgery etc then consider a 3.5x, 4.0x or even 5.0x but please remember that the higher the magnification the smaller the working distance and field of view.

Your local medical supplier is just a phone call away. See cover for full details

Prices shown are exclusive of VAT and delivery

OPTICLAR VISIONMAG Pro-Line I.O Loupes



Code	Magnification	Working Distance mm	Price
402.025.340	2.5x	340	£499.00
402.025.420	2.5x	420	£499.00
402.025.460	2.5x	460	£499.00
402.025.500	2.5x	500	£499.00
402.030.340	3.0x	340	£499.00
402.030.420	3.0x	420	£499.00
402.030.460	3.0x	460	£499.00
402.030.500	3.0x	500	£499.00

With a twin lens system the Pro-Line range of loupes provide excellent edge to edge clarity with no aberration. The individually adjustable optics ensure accurate interpupillary setting. Coated optics minimise reflections and maximise light transmission to provide crisp bright images. The unique height adjuster provides perfect pupillary alignment. The extreme angles of declination available ensures that these loupes are ideal for dentistry as well as all other forms of examination, other disciplines and surgery. Very comfortable, lightweight yet strong sports frame.

OPTICLAR Loupe Light for I.O Loupes

Fitted with a high quality LED the Opticlar I.O loupe light provides brilliant homogenous illumination free from chromatic aberration. The compact lithium ion battery pack can provide up to 12 hours continuous use and fully recharges in less than 2 hours. With compact dimensions the battery pack can sit unobtrusively in the pocket or clipped to waist band or belt. The connection cable has a coiled section that provides an early warning if the cable is snagged on furniture or other objects. A separate on/off switch prevents premature wear on the rotary rheostat and enables the unit to be turned on/off at the previously chosen setting.



500.000.054 **£399.00**
OPTICLAR Loupe Light IO

Your local medical supplier is just a phone call away. See cover for full details

Prices shown are exclusive of VAT and delivery



OPTICLAR VISIONMAG Pro-Line S.O Loupes

The Pro-Line S.O range of loupes provide excellent edge to edge clarity with no aberration. The centrally adjustable optics feature oversize oculars that compensate for relative differences in interpupillary distance and make the Pro-Line S.O. range very easy to set up. Coated optics minimise reflections and maximise light transmission to provide crisp bright images. Ideal for users who have small interpupillary differences

Code	Magnification	Working Distance mm	Price
404.025.340	2.5x	340	£499.00
404.025.420	2.5x	420	£499.00
404.025.460	2.5x	460	£499.00
404.025.500	2.5x	500	£499.00
404.030.340	3.0x	340	£499.00
404.030.420	3.0x	420	£499.00
404.030.460	3.0x	460	£499.00
404.030.500	3.0x	500	£499.00

OPTICLAR Loupe Light for - Pro-Line - S.O - Superview Loupes



The S class loupe light provides intense homogenous illumination suitable for all procedures. The lithium polymer rechargeable battery pack has a 6 stage illumination control that provides between 4-12 hours use dependant upon illumination setting. With a recharge time of approximately 2 hours the loupe light provides sufficient run time for most applications. A yellow filter is included for dentistry applications.

The light sits coaxially between the lenses and ensures that illumination is in the correct position.

500.000.060	£399.00
OPTICLAR Loupe Light for - Pro-Line - S.O - Superview Loupes	

Your local medical supplier is just a phone call away. See cover for full details

Prices shown are exclusive of VAT and delivery

OPTICLAR VISIONMAG Pro-Line Superview Loupes

The Pro-Line SuperView Prismatic range of loupes feature advanced lightweight optical components that provide excellent edge to edge clarity with no aberration and low weight. A combination virtually unheard of with prismatic loupes. The individually adjustable optics make the Pro-Line SuperView range very easy to set up. Coated optics minimise reflections and maximise light transmission to provide crisp bright images.



Code	Magnification	Working Distance mm	Price
406.040.340	2.5x	340	£599.00
406.040.420	2.5x	420	£599.00
406.040.460	2.5x	460	£599.00
406.040.500	2.5x	500	£599.00
406.050.340	3.0x	340	£599.00
406.050.420	3.0x	420	£599.00
406.050.460	3.0x	460	£599.00
406.050.500	3.0x	500	£599.00

OPTICLAR Loupe Light for - Pro-Line Superview Loupes



The S class loupe light provides intense homogenous illumination suitable for all procedures. The lithium polymer rechargeable battery pack has a 6 stage illumination control that provides between 4-12 hours use dependant upon illumination setting. With a recharge time of approximately 2 hours the loupe light provides sufficient run time for most applications. A yellow filter is included for dentistry applications.

The light sits coaxially between the lens and ensures that illumination is in the correct position.

500.000.060 **£399.00**
 OPTICLAR Loupe Light for Pro-Line Superview

Your local medical supplier is just a phone call away. See cover for full details

Prices shown are exclusive of VAT and delivery

OPTICLAR VISIONMAX

OPTICLAR VISIONMAX Personal Lighting

Whether in the individual practitioners office settings or in the OR proper lighting makes all work tasks easier. Individuals receive approximately 85% of their information through their sense of sight. Appropriate lighting without glare or shadows can reduce eye fatigue and headaches and it can help minimise workplace mistakes and inaccurate conclusions.

OPTICLAR VISIONMAX LED Headlights

Spectacle Mounted



3W LED Headlight



5W LED Headlight



'Touch-Start' LED Headlight

OPTICLAR specialist lighting has been designed for the Medical Professional and enables examinations, minor procedures and surgical processes to be effectively performed. It enables staff to perform their duties with the optimum light and we strive to create the very best lighting conditions.

By choosing OPTICLAR LED luminaires you are ensuring the best possible lighting combined with the most energy efficient and practical options available. Our goal is to provide lighting equipment which is taken for granted and which performs its duties day in day out without fuss or problems, enabling staff to carry out their procedures without worry.

We understand the essential differences between practice based lighting and individual personal lighting.

Our goal is to provide personal lighting for the individual user that is highly effective and value for money. The OPTICLAR range has been designed to fulfil the following criteria:-

- Quality of illumination with exceptional brightness (circa 60,000lux)
- Exceptional colour temperature (circa 5500-6000k)
- Homogenous light spot giving edge to edge consistent illumination and optimal illumination spot size
- Battery life; lithium polymer batteries provide up to 12 hours use at maximum illumination. Quick recharge time of less than 2 hours
- Compact dimensions to reduce belt weight and increase comfort.

Compact: Battery dimensions and lightweight ensures battery pack is comfortable to wear either belt mounted or inside pocket.

Comfortable: Experience shows that if a headlight is not comfortable it will not be used. All OPTICLAR head lights are designed for comfort over extended periods of use.

Modular: Our 3w range is entirely interchangeable and the basic unit can be used as a loupe light, spectacle mounted light, sports headband or professional headband mounted. If you require a variety of mounting options there is no need to purchase additional lights. Simply add the mount of your choice.

Reliability: Use of high quality raw materials and components together with world class assembly techniques ensures high degrees of reliability and longevity.

Ease of use: with simple logical controls all Opticlar VisionMax headlights are easy and intuitive to use. Easy adjustment of illumination via continuously adjustable rheostat. A separate on/off switch ensures unit is at your preferred level of brightness the next time it is turned on (certain models only).

Your local medical supplier is just a phone call away. See cover for full details

Prices shown are exclusive of VAT and delivery

OPTICLAR VISION^{LED}MAX

OPTICLAR VISIONMAX VM3 LED Headlight

With a brilliant 3W LED the VM3S provides homogenous illumination and is ideal for most disciplines and especially suitable for domiciliary and paramedic applications.

- Quality illumination and exceptional brightness - circa 60,000 lux
- Exceptional colour temperature - circa 5,500 - 6,000k
- Homogenous light spot providing edge to edge consistent illumination and optimal spot size
- Up to 12 hours continuous use from full charge of battery
- 2 hour quick recharge time
- Orange filter included for dentistry or light sensitive patients

- Compact dimensions reduce belt weight and increase comfort
- Adjustable rheostat promotes easy adjustment of illumination
- Available in flexible options:
 - On sports frame with clip in prescription lenses
 - Universal fitting for use on all spectacles
 - Sports headband (see following page)
 - Professional headband (see following page)



500.020.000

OPTICLAR VISIONMAX Spectacle Headlight with Dedicated Spectacle Fitting

- Clip in prescription lens frame
- Supplied with attractive carry case
- Lightweight sports-style frame

OPTICLAR VISIONMAX Spectacle Headlight Universal Fitting

- Universal fitting for use on all spectacles
- Supplied with attractive carry case

500.020.000	£549.00
OPTICLAR VISIONMAX 3 Spectacle Headlight	
500.020.000/1	£79.00
Dedicated Spectacle Mount with Light Mounting	

500.020.002	£499.00
OPTICLAR VISIONMAX 3 Spectacle Headlight with Universal Fitting	
500.020.002/1	£45.00
Universal Clip only with Light Mounting	

Your local medical supplier is just a phone call away. See cover for full details

Prices shown are exclusive of VAT and delivery

Lighting Headworn

OPTICLAR VISIONMAX

OPTICLAR VISIONMAX 3 Headlight on Sports Headband

- Fully adjustable lightweight sports headband
- Storage carry case
- Optional orange filter included



500.010.020	£549.00
OPTICLAR VISIONMAX 3 headlight on Sports Headband with storage/carry case	
500.010.020/1	£79.00
Lightweight Sports Headband only with Light Mounting	

OPTICLAR VISIONMAX 3 Headlight on Professional Headband



- Professional overhead headband with central point adjustment
- Storage carry case

Can be supplied with Opticlar Pro-Line 402 series loupes for added versatility

500.010.010	£599.00
OPTICLAR VISIONMAX 3 headlight on Professional Headband with storage/carry case	
500.010.010 340	£749.00
OPTICLAR VISIONMAX 3 headlight with 340mm 2.5 x Loupes	
500.010.010 420	£749.00
OPTICLAR VISIONMAX 3 headlight with 420mm 2.5 x Loupes	
500.010.010 460	£749.00
OPTICLAR VISIONMAX 3 headlight with 460mm 2.5 x Loupes	
500.010.010 500	£749.00
OPTICLAR VISIONMAX 3 headlight with 500mm 2.5 x Loupes	
500.010.010/1	£99.00
Professional Headband only with light fitting	

Your local medical supplier is just a phone call away. See cover for full details

Prices shown are exclusive of VAT and delivery

**OPTICLAR VISIONMAX 5
Professional Headband Mounted LED Light**

**5W LED Focussing Light with
Lithium Ion cell and charger**

- Variable focus enabling accurate adjustment of image
- Quality illumination and exceptional brightness - circa 60,000 lux
- Exceptional colour temperature - circa 5,500 - 6,000k
- Homogenous light spot providing edge to edge consistent illumination and optimal spot size
- Up to 10 hours continuous use from full charge of battery
- 2 hour quick recharge time
- Compact dimensions reduce belt weight and increases comfort
- Adjustable rheostat promotes easy adjustment of illumination
- Overhead headband with centre point adjustment
- Supplied with attractive carry case



500.020.010 £699.00

500.020.010 340	OPTICLAR VISIONMAX 5 headlight with 340mm 2.5 x Loupes	£849.00
500.020.010 420	OPTICLAR VISIONMAX 5 headlight with 420mm 2.5 x Loupes	£849.00
500.020.010 460	OPTICLAR VISIONMAX 5 headlight with 460mm 2.5 x Loupes	£849.00
500.020.010 500	OPTICLAR VISIONMAX 5 headlight with 500mm 2.5 x Loupes	£849.00

OPTICLAR Professional Headband Mounted 'Touch-Start' LED Light

With its dual pannier mounted rechargeable batteries this innovative headlight provides the ultimate in portability and freedom of movement. With no cables, users have unrestricted 360° of movement around the examination or operating site.

With its lightweight and excellent working time the new Wireless LED is ideal for most procedures. It's unique touch sensitive panel enables the user to quickly and easily control the desired illumination level and is very easy to keep clean. Unlike wall mounted charging systems that cannot easily be moved the novel charging dock further enhances the units mobility by enabling it to be moved between examination rooms and clinics quickly and easily. Replacement batteries are quickly and easily fitted and are realistically priced.

- Illumination - TrueTone high definition LED
- Lux >35,000 lux @ 30cm
- CRI >90
- Charge time - fully discharged to fully charged - approx. 3.5 hours
- Working time at full illumination >3.5 hours
- Weight of complete unit including batteries approx. 440g
- Spot size at 40cm 12mm to 75mm, continuously adjustable



500.020.015	Opticlar Wireless LED headlight with charging dock	£1429.00
500.020.015/1	Spare lithium polymer batter	£139.00

Your local medical supplier is just a phone call away. See cover for full details

Prices shown are exclusive of VAT and delivery

Lighting Headworn

OPTICLAR VISION^{LED} MAX

Despite the recent advances made with LED power sources Xenon still remains the illumination system of choice for major surgery and especially where colour rendering and tissue colour differentiation is critical such as Neuro and Cardiovascular.

The OPTICLAR Xenon system is manufactured in conjunction with one of the oldest established names in Xenon lighting and we are pleased to include these products within our range under the Opticlar F.O.X. Banner.

In addition to Xenon systems we have collaborated on a range of new high power LED projectors that offer much of the advantages and features of Xenon projectors with the added benefit of LED systems such as long life illumination systems and low running costs.

For those departments wishing to renew or include Xenon or LED headlight systems we offer a no obligation trial period to ensure that the system chosen is correct for the intended applications. In addition we can offer loan periods for those units wishing to use Xenon/LED systems on a case by case basis or where finance is being discussed.

With a variety of headbands suitable for general surgery, ENT and specialised surgery there is an Opticlar Xenon/LED headlight system suitable for most applications.

OPTICLAR Standard Headband Fibre Optic Headlight

- Competitively priced, entry level model ideal for day to day use in the busy OR environment
- Sturdy and robust but lightweight and comfortable
- Adjustable light spot diameter
- Easy adjustment for position and angle of luminaire
- Comfort headband with washable brow and crown pads
- Ideal for use with face masks and shields
- Suitable for use with Halogen or Xenon projectors
- Fibre optic cable can be easily replaced if damaged
- Wolf and Storz cable fittings supplied as standard

Please state the type of standard connector required. Wide variety of alternative connectors are available, please ask for details.



500.030.000

£599.00

Your local medical supplier is just a phone call away. See cover for full details

Prices shown are exclusive of VAT and delivery

OPTICLAR Focusable Professional Headband Fibre Optic Headlight

The most popular headlight with a choice of single fibre optic cable or bifurcated twin cable in standard weight and lightweight versions. The joystick positioning control is autoclaveable and easy to insert and remove and enables the light head to be set at any desired angle. Excellent homogenous illumination regardless of the spot size chosen. The 2.5mt length cable ensures mobility around the operating site and cable 'glow' is minimal to reduce light loss yet sufficient to ensure the cable is visible even with main operating lights in use. Supplied with Storz fitting as standard, other fittings available upon request.

- Extremely strong, focusable fibre optic headlight
- Lightweight and comfortable for long operations
- Adjustable light spot diameter
- Easy adjustment for position and angle of luminaire
- Professional comfort headband with washable brow and crown pads
- Loupe fitting (certain models)
- Ideal for use with face masks and shields
- Suitable for use with Halogen or Xenon projectors
- Single cable with large range of cable ends to fit most machines
- Choice of mono or bifurcated cables



Please state the type of standard connector required. Wide variety of alternative connectors are available, please ask for details.

500.030.010	£1099.00
OPTICLAR Focusable FO Headlight with mono cable	
500.030.012	£1199.00
OPTICLAR Focusable FO Headlight with bifurcated cable	
500.030.014	£1299.00
Focusable FO Headlight with lightweight bifurcated cable	

OPTICLAR Comfort Headband Fibre Optic Mini Headlight

With a micro headlight this OPTICLAR headlight is ideal for ENT and Dental surgery or other applications that require illumination in deep cavities. Focusable, with very small dimensions the light head can easily be positioned. Supplied with a 2.5mt cable with Storz fitting as standard.

- Ideal for ENT and other disciplines requiring excellent light transmission and lightweight quality
- Focusable mini headlight with comfort headband
- Extremely lightweight 3.5mm bundle
- Adjustable light spot diameter
- Easy adjustment for position and angle of luminaire
- Comfort headband with washable brow and crown pads
- Suitable for use with Halogen or Xenon projectors
- Fibre optic cable can be easily replaced if damaged
- Wide range of cables to suit most types of projectors



Please state the type of standard connector required. Wide variety of alternative connectors are available, please ask for details.

500.030.018	£869.00
--------------------	----------------

Your local medical supplier is just a phone call away. See cover for full details

Prices shown are exclusive of VAT and delivery

Lighting Headworn

OPTICLAR LED Light Sources

The Opticlar range of light sources provide the optimum illumination for the majority of surgical disciplines.

From cost effective Halogen to performance orientated Xenon and new technology LED there is an Opticlar light source suitable for all your needs from outpatient examinations to lengthy surgical procedures

LED Light Sources

- Stepless illumination control
- Rheostat control of illumination from 30% to 100% with no affect to colour temperature
- 10,000 hour bulb life
- Storz interface with others available on request
- 6,300 Kelvin colour temperature
- BNC Video input terminal

Model 1000

- Output comparable to 100w Xenon
- Connections - Storz or Wolf

Model 3000

- Output comparable to 300w Xenon
- Minimal heat sink to outside environment
- Connections - Turret assembly including Wolf, Storz, Olympus and ACMI

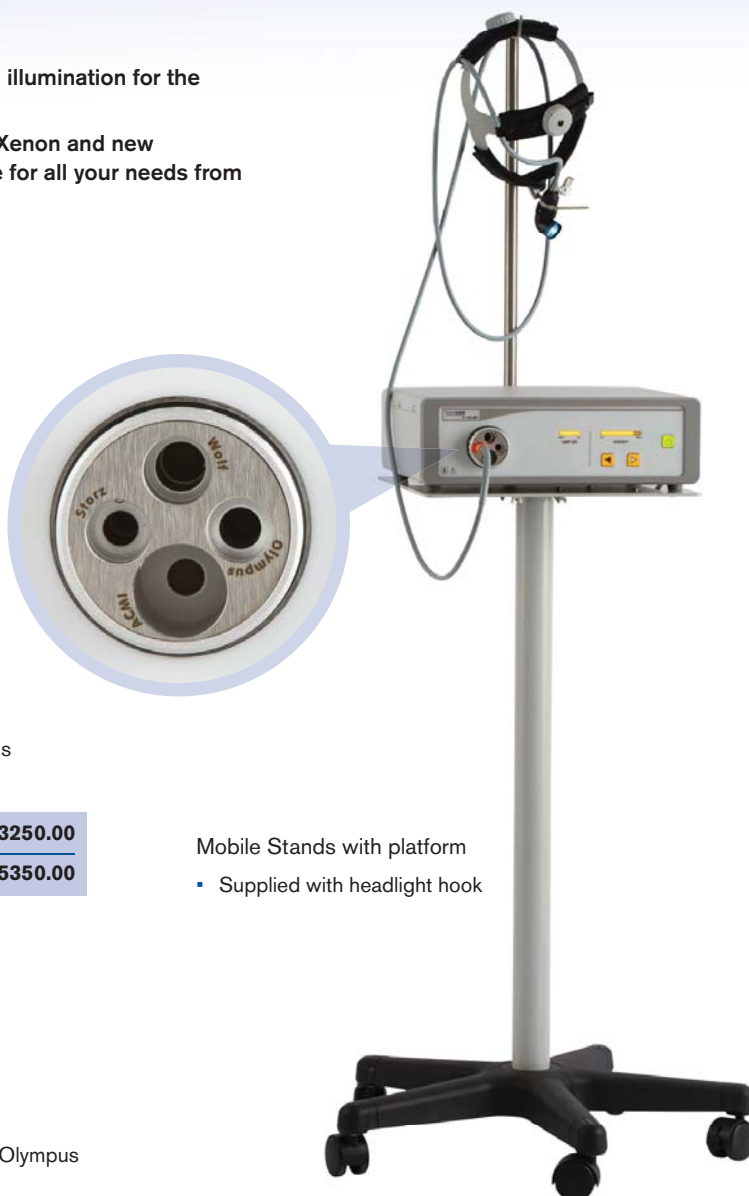

Mobile Stands with platform

- Supplied with headlight hook

500.050.100 Opticlar LED 1000 Light Source **£3250.00**

500.050.300 Opticlar LED 3000 Light Source **£5350.00**

Opticlar Fibre Optic Xenon Light Source 100w

- Concave mirror achieves maximum power output
- Short arc emits very minimal heat with very low heat sink
- Diaphragm light adjustable intensity
- Easy replacement of bulbs
- Supplied with turret system including Storz, Wolf, ACMI and Olympus

500.070.100 Opticlar F.O.X 100w Projector with turret **£3395.00**

500.070.100/1 Replacement Xenon 100w Bulb **£449.00**

500.080.002 400 x 350mm platform

£409.00

Opticlar Fibre Optic Xenon Light Source 180w

- Optimum efficiency in light generation and transmission
- Diaphragm light adjustable intensity delivering highest levels of colour rendering
- 5800k colour temperature
- Easy replacement of bulbs
- Lamp life indicator mounted and easily viewed on front panel
- Self check on initial start up
- Quick fan thermostatically regulated
- Minimal heat sink to outside environment
- Turret cable interface with Storz, Wolf and Olympus/ ACMI ports

500.070.180 Opticlar F.O.X 180w Projector with turret **£3800.00**

500.070.180/1 Replacement Xenon 180w Bulb **£449.00**

Opticlar Fibre Optic Xenon Light Source 300w

- Utilises discharge lamp filled with non polluting Xenon gas
- Diaphragm light adjustable intensity delivering highest levels of colour rendering
- Provides near daylight illumination
- 5600k colour temperature
- Lamp life indicator mounted and easily viewed on front panel
- Turret cable interface with Storz/ Olympus/ ACMI ports
- Automatic self check on start up
- Quiet fan thermostatically regulated
- Minimal heat sink to outside environment

500.070.300 Opticlar F.O.X 300w Projector with turret **£5290.00**

500.070.300/1 Replacement Xenon 300w Bulb **£449.00**

Your local medical supplier is just a phone call away. See cover for full details

Prices shown are exclusive of VAT and delivery

F.O.X Integrated Systems

Opticlar LED 100 System

The LED 100 systems include LED 100 projector, comfort headlight with 2.5mt mono cable and projector stand with headlight boom.

500.090.100LED Opticlar LED 100 System **£4750.00**

Opticlar F.O.X 100w System

The F.O.X 100w systems include 100w Xenon projector with turret, comfort headlight with turret, comfort headlight with 2.5mt mono cable and projector stand with headlight boom

500.090.100FOX Opticlar F.O.X 100w System **£4750.00**

Opticlar F.O.X 180w System

The F.O.X 180w systems include 180w Xenon projector with turret, comfort headlight with turret, comfort headlight with 2.5mt bifurcated cable and projector stand with headlight boom

500.090.180FOX Opticlar F.O.X 180w System **£4750.00**

Opticlar LED 300 System

The LED 300 systems include LED 300 projector, comfort headlight with 2.5mt lightweight bifurcated cable and projector stand with headlight boom. (Please specify Storz or Wolf fitting, Storz supplied if none specified)

500.090.300LED Opticlar LED 300 System **£6750.00**



Lumatic LED Headlight



- Small and lightweight (only 63g)
- High brightness and visibility by
- 5 LEDs, permanent or blinking light
- Detachable lamp
- Battery 1.5V ABA (included)
- Dimensions: 72 x 58 x 32mm

43.2020.01 Lumatic LED-Headlight **£20.20**

Lumatic LED Headlight with high/low intermittent setting



- Lightweight (only 91g)
- 3 LEDs, permanent or blinking light
- Adjustable up to 80% from horizontal
- 2 x CR2032 batteries (included)

43.3008 Lumatic LED-Headlight with high/low settings **£44.90**

Lumatic LED Opti Focus Headlight

- 155g weight
- 3 x 1.5V AAA batteries (included)



43.2021 Lumatic LED Opti Focus Headlight **£34.70**

Your local medical supplier is just a phone call away. See cover for full details

Prices shown are exclusive of VAT and delivery

Blood Pressure Hand Held Aneroids

Designed for the busy surgery requiring the very best in terms of practical use and long term value for money. With product on offer from Bosch & Sohn (BoSo) and Guardian you can be sure of excellent reliability, longevity and ease of use. 15 year warranty on all BoSo units in this category and 5 year for Guardian ensures peace of mind.



GUARDIAN®

BoSo Solid

For those more traditional surgeries requiring a screw type of connector, the Bosch Solid is the perfect unit. With its high quality threaded connector cuff changes are easy to perform. The large dial with 'ClearView' markings ensures easy readings even in poor lighting

- Protective metal construction
- Instant cuff connection
- Completely Latex-free
- Shockproof Manometer
- 50mm dial, clear and easy to read
- Traditional screw type air release
- Includes zip storage pouch



50.06.113 BoSo Solid aneroid sphygmo **£54.70**

For replacement or alternative size cuffs please see Section 1 on page 77

BoSo Roid

Simply push on/pull off renders cuff changing easy. ClearView dial and metal construction for ease of use and longevity.

- Precise easy read 60mm dial
- Thread lock cuff connector system
- Completely Latex-free
- Shockproof Manometer
- Protective metal rim
- Traditional air release system
- Leatherette storage case



50.07.123 BoSo Roid aneroid sphygmo **£50.70**

For replacement or alternative size cuffs please see Section 1 on page 77

BoSo Classico

Beautifully designed and manufactured the Classico is available in Cool Black finish. Shock proof chamber with shock absorbing rim, twin tube within tube design for smooth measurement.

- Metal construction in matt black finish
- Smooth air release system
- Twin tube inflation system, stops 'jumping' of needle
- Completely Latex-free
- Shock proof Manometer
- Smart design for the modern practitioner
- Includes zip fastening pouch



50.09.113 BoSo Classico aneroid sphygmo **£53.00**

For replacement or alternative size cuffs please see Section 2 on page 77

Your local medical supplier is just a phone call away. See cover for full details
Prices shown are exclusive of VAT and delivery

Hand Held Aneroids Blood Pressure

Built to exacting standards the Essentials range provides quality, reliability and excellent value for money. To comply with European quality standards every individual Bosch & Sohn (BoSo) unit is tested for accuracy before leaving the factory. Quality and accuracy at a bargain

price. Shock proof and drop proof chamber. All BoSo Essentials range units carry a 10 year warranty for peace of mind and all Guardian units a generous 5 year warranty.

BoSo Clinicus



- Lightweight ABS construction
- Completely Latex-free
- Shockproof Manometer
- Strong and durable
- Traditional air release system
- Large easy to read 60mm dial
- Includes zip fastening pouch
- Available in black, blue, green or red. Please specify colour when ordering.



50.08.113 BoSo Clinicus aneroid sphygmo £42.35

For replacement or alternative size cuffs please see Section 1 on page 77

BoSo Varius



- Economically Priced – with no compromise on quality
- Shock and Corrosion Protected Manometer
- Safe Against Overpressure – a common cause of manometer failure from over-inflation
- 60mm Dial – clear and easy to read
- Latex Free Cuff and Pouch – included as standard
- Unbreakable Plastic Casing
- 10 Year Guarantee – against failure of the manometer mechanism



50.08.120 BoSo Varius £33.70

For replacement or alternative size cuffs please see Section 1 on page 77

Your local medical supplier is just a phone call away. See cover for full details
Prices shown are exclusive of VAT and delivery

Blood Pressure Hand Held Aneroids

For ambidextrous use

BoSo Profitest

- Push button valve, instant air release
- Two-tone design
- Completely Latex-free
- Shockproof Manometer
- Strong and light ABS construction
- Clear and easy to read 60mm dial
- Quick and easy to use
- Choice of red/black or grey/white
- Includes zip storage pouch

50.08.110 **£39.30**

BoSo Profitest aneroid sphygmo, red/black

50.08.110W **£39.30**

BoSo Profitest aneroid sphygmo, grey/white



For replacement or alternative size cuffs please see Section 1 on page 77

Guardian Pro Berlin Aneroid

- High quality aneroid with pressure safe mechanism
- Luminous dial for low light situations
- Impact resistant housing
- Chromium plated body
- Latex free cuff
- Storage pouch

51.32.000 **£38.80**

Guardian Pro Berliner Aneroid sphygmo with adult cuff

For replacement or alternative size cuffs please see Section 1 on page 77



AW Clip-on

- Reliable sphygmo, ideal for nursing
- Separate dial and inflation bulb
- Dial clips to cuff for easy reading
- Screw valve air release
- Adult velcro cuff
- 12 month warranty
- Supplied in storage pouch



For replacement or alternative size cuffs please see Section 1 on page 77

51.06.113 **£22.50**
AW Clip-on aneroid sphygmo

Guardian Pro Europa

Superb model with a rotating pump body ensuring that the unit is comfortable for left and right handed use.

- High quality aneroid with pressure safe mechanism
- Easy read dial
- Impact resistant housing
- Chromium plated body
- Latex free cuff
- Slip resistant inflation bulb
- Storage pouch



For replacement or alternative size cuffs please see Section 1 on page 77

51.34.000 **£39.80**
Guardian Pro Europa Model sphygmo with adult cuff



Your local medical supplier is just a phone call away. See cover for full details

Prices shown are exclusive of VAT and delivery

Wall Mounted Aneroids Blood Pressure

Guardian Pro Wall Model

- Measurement range 0 – 300mm Hg
- Spiral tube
- Adult cuff
- Accurate and reliable
- Easy to read large dial



51.12.000		£74.50
Guardian Pro Wall mounted aneroid Sphygmo with adult cuff		
P-102NI	Guardian Nylon Cuff - Infant 24.5 x 8cm	£4.95
P-102NP	Guardian Nylon Cuff - Paediatric 35 x 11cm	£4.95
P-102WDX	Guardian Nylon Cuff - Adult 51 x 14.2cm	£6.95

For replacement or alternative size cuffs please see Section 4 on page 77



BoSo Nova S® Wall Mounted

- Specially designed aneroid sphygmomanometer developed for use in surgeries and clinics
- Generously dimensioned 120mm high contrast scale layout for optimum readability
- Hardened diaphragm guarantees accurate pressure readings up to 300mm Hg
- Resilient, non-corrosive mechanism
- Manometer safe against overpressure and equipped with a non-corrosive mechanism
- Spacious holder on the reverse side for tubes and cuffs
- Air-release valve with fine adjustment
- Latex free cuffs
- Two tube system
- Maximum error tolerance: ± 3 mm Hg



166-0-121 boso Nova S Aneroid, Wall model **£96.00**

For replacement or alternative size cuffs please see Section 4 on page 77

Your local medical supplier is just a phone call away. See cover for full details
Prices shown are exclusive of VAT and delivery

Blood Pressure Table Top Aneroid

TABLE TOP ANEROIDS

BoSo Nova S® Table Top

- Specially designed aneroid sphygmomanometer developed for use in surgeries and clinics
- Generously dimensioned 120mm high contrast scale layout for optimum readability
- Hardened diaphragm guarantees accurate pressure readings up to 300mm Hg
- Resilient, non corrosive mechanism
- Manometer safe against overpressure and equipped with a non-corrosive mechanism
- Spacious holder on the reverse side for tubes and cuffs
- Air-release valve with fine adjustment
- Latex free cuffs
- Two tube system
- Maximum error tolerance: ± 3 mm Hg



165-0-121 boso Nova S Aneroid, table top	£89.00
167-0-121 boso Nova S Aneroid, Bed rail model	£110.00

For replacement or alternative size cuffs please see Section 4 on page 77

Guardian Pro Table Model

- Measurement range 0 – 300mm Hg
- Spiral tube
- Adult cuff
- Space saving base
- Accurate and reliable
- Easy to read large dial



51.10.000 Guardian Pro Table top aneroid Sphygmo with adult cuff	£74.50
--	--------

For replacement or alternative size cuffs please see Section 4 on page 77

Your local medical supplier is just a phone call away. See cover for full details
Prices shown are exclusive of VAT and delivery

MOBILE MOUNTED MODELS



BoSo Nova S® Mobile

- Specially designed aneroid sphygmomanometer developed for use in surgeries and clinics
- Generously dimensioned 120mm high contrast scale layout for optimum readability
- Hardened diaphragm guarantees accurate pressure readings up to 300mm Hg
- Resilient, non-corrosive mechanism
- Manometer safe against overpressure and equipped with a non-corrosive mechanism
- Spacious holder on the reverse side for tubes and cuffs
- Air-release valve with fine adjustment
- Latex free cuffs
- Two tube system
- Maximum error tolerance: ± 3 mm Hg
- Includes telescopic adjustable trolley with 5 point anti-tip base.

For replacement or alternative size cuffs please see Section 4 on page 77

168-0-121

boso Nova S Aneroid, Tripod model

£193.70

Guardian Pro Mobile Model

- Measurement range 0 – 300mm Hg
- Spiral tube
- Adult cuff
- Accurate and reliable
- Easy to read large dial
- Height adjustable non tip stand
- Storage basket



For replacement or alternative size cuffs please see Section 4 on page 77

51.14.000

Guardian Pro Mobile aneroid Sphygmo with adult cuff

£120.40

Your local medical supplier is just a phone call away. See cover for full details

Prices shown are exclusive of VAT and delivery

Blood Pressure Peripheral Arterial Occlusive Disease Equipment

Bosch and Sohn (BoSo) ABI

System 100 – Saving lives through early detection of PAOD

Procedure
can be
undertaken by
non-qualified
individuals



The worlds first ABI system with many thousands of units in use in Germany the BoSo ABI 100 provides a completely new method of measuring the Ankle Brachial Index. A simple routine check with the BoSo 100 can help to save lives.

Peripheral arterial occlusive disease (PAOD) is often the forerunner of cardiovascular events with very serious consequences. Unfortunately even in high risk groups such as smokers, diabetics and the elderly, PAOD is often diagnosed too late with tragic personal consequences.

BoSo ABI calculates the crucial values quickly, precisely and reliably without the need for Doppler. All of BoSo's decades of experience manufacturing precision blood pressure measuring equipment is incorporated into the ABI 100 making it easy and very simple to use and understand.

Professional testimonies from well respected individuals such as Prof. Med. Curt Diehm, Head of Department, Internal and Vascular Medicine, Karlsbad-Langensteinbach Clinic, University of Heidelberg highlight the enormous advantages of the BoSo System 100

“ The innovative method used by the BoSo ABI-system 100 creates broad applications for ABI determination in medical practice because the test can be carried out in a few minutes without any special preparations. Doctors and patients alike benefit from this service spectrum, which makes possible accurate diagnosis and early targeted treatment. ”

After simple training the BoSo ABI System can be taking measurements in minutes and the supplied software has an internal database that offers patient management, graphic representation of measured values and a GDT interface that allows export to the practice data processing system.

The BoSo ABI 100 was designed to save lives – quickly, accurately and affordably.



The BoSo ABI 100 was designed to save lives – quickly, accurately and affordably.

466-0-141
BoSo ABI – System 100

£2595.00

Your local medical supplier is just a phone call away. See cover for full details

Prices shown are exclusive of VAT and delivery

Self Testing Sphygs Blood Pressure

BoSo Carat Synchro Pressure Monitor

Innovative new simultaneous blood pressure monitor specially designed to enable the measurement of blood pressure on both arms. This facility is important for determining the risk of cardiovascular events. There are many recommendations to measure on both arms as a difference of 15mmHg increases the risk of all-cause mortality by 60% (Lancet. 2012 Mar10; 379(9819): 905-14. doi:10.1016/S0140-6736(11)61710-8. Epub 2012 Jan 30).

Specially designed for the exacting requirements in hospitals and GP surgeries the main benefit of the Boso Carat Synchro is by taking the measurement on both arms there is no distortion due to variations in blood pressure.

- Intelligent inflation technology allows gentle and rapid measurement with additional pumping
- Irregular heartbeat is detected and displayed during measurement
- Operates with supplied AC power - AC adaptor
- Equipped with two universal velcro cuffs for arm circumferences 22 - 42cm fitting the majority of patients



472-0-141

BoSo Carat Synchro Blood Pressure Monitor

£489.00



BoSo Medilife

- Compact design
- 30 memory blocks provide 14 day profile
- Large 3 value display
- Supplied with storage case, batteries and blood pressure record card

60.13.000

BoSo Medilife

£46.95

Your local medical supplier is just a phone call away. See cover for full details

Prices shown are exclusive of VAT and delivery

Blood Pressure Self Testing Sphygs

The BoSo Medicus family of digital BP units is one of the most comprehensive and respected range of digital BP units available with models suitable for professional and home use.

BoSo Medicus Exclusive

The premium blood pressure instrument for health assessment

- Optimises blood pressure assessment
- High-quality finish and comprehensive range of functions
- Extra large digital display provides brilliantly clear readings
- Speech output function ensures the elderly and visually impaired can easily measure their own blood pressure
- Precise blood pressure measurement at the upper arm – clinically validated
- Intelligent pump-action for optimal inflation to the required pressure
- Movement error indicator helps to avoid false readings
- Selectable speech function (5 languages) with volume control
- Memory for 90 readings with date and time – monthly overview, if 3 measurement per day, additional guest mode
- Irregular heart beat indication
- Display of average values for a thorough blood pressure assessment during the day (morning / afternoon)
- Evaluation of blood pressure according to WHO-classification
- Tri-check function - automatic, three-time measurement and averaging
- Cuff for arm circumference 22 - 42 cm
- High-quality carrying case
- Batteries included

All units are CE marked and are independently validated by the respected German TUV. Certain models have been clinically validated by the German Hypertensive Society. All models have a 3 year manufacturers warranty.



471-0-143 BoSo Medicus Exclusive £89.00



BoSo Medicus Control

- Evaluation of BP as per WHO guidelines
- Average value indicator
- 30 memory blocks for 14 day profile
- Irregular heart beat indication
- Optional extra large cuff available
- Supplied with carrying case, adult cuff, batteries and record card

60.32.000 £73.45
BoSo Medicus Control complete

143-4-750 £26.05
Adult cuff for Medicus Control 22-32cm circumference

143-4-757 £34.70
Extra large adult cuff for Medicus Control 33-41 cm circumference

BoSo Medicus Uno

- Simple one button operation
- Memory of last measurement
- Irregular heart beat indication
- Optional extra large cuff available
- Supplied with carrying case, adult cuff, batteries and record card



60.36.000 £70.30
BoSo Medicus Uno complete

Spares and Accessories

143-4-750 £26.05
Adult cuff for Medicus Uno 22-32cm circumference

143-4-757 £34.70
Extra large adult cuff for Uno 33-41cm circumference

Your local medical supplier is just a phone call away. See cover for full details

Prices shown are exclusive of VAT and delivery

BoSo Medicus Prestige

- Classical upper arm model especially suitable for the elderly and patients suffering from diabetes and/or rheumatism
- Single push button operation
- 30 measurement memory for 14 day profile
- Very comfortable measurement due to SoftMatic measurement and fast deflation
- Average value and irregular heart beat indicator
- Extra large 8.6cm 3 value display of systolic, diastolic and heart rate
- Optional extra large and extra small cuff available
- Optional speaking unit with acoustic output for the visually impaired
- Supplied with carrying case, adult cuff, batteries and record card



60.30.000 BoSo Medicus Prestige	£76.00
60.30.010 BoSo Medicus Prestige GP Package includes 1 x standard cuff, 1 x XS cuff, 1 x XL cuff	£130.55

Spares and Accessories

141-4-771 Extra small cuff 16-22cm circumference	£27.05
143-4-750 Adult size cuff 22-32cm circumference	£26.05
143-4-756 Extra large cuff 33-41cm circumference	£31.40

BoSo Medicus Standard and PC Plus

For patients with manifest hypertension, monitoring is optimised by using the Medicus PC Plus (60.17.000). The patient can take his blood pressure at home and upon returning to the GP the stored data can be downloaded and used to generate a detailed long term profile including graphics. With this information medication can be precisely controlled to reduce side effects, improve blood pressure and reduce medication costs.

- Fully automatic with single push button operation
- Four set inflation levels avoids over inflation
- Large 3 value display
- Optional PC compatible units available
- BoSo Medicus PC Plus (60.17.000) has 169 memory blocks and is supplied with PC software
- Supplied with carrying case, adult cuff, batteries and record card



60.10.000
BoSo Medicus



60.17.000
BoSo Medicus PC Plus



60.10.000 BoSo Medicus	£80.45
60.17.000 BoSo Medicus PC Plus	£122.40

Spares and Accessories

143-4-750 Adult cuff for Medicus range 22-32cm circumference	£26.05
143-4-757 Large adult cuff for Medicus range 33-41 cm circumference	£34.70

Your local medical supplier is just a phone call away. See cover for full details
Prices shown are exclusive of VAT and delivery

Blood Pressure Self Testing Sphygs

Guardian Pro-Check GP32

The Guardian Pro-Check 32 utilises the latest digital BP algorithms to produce a highly accurate yet very simple to use digital BP unit.

Specifically designed for use in a clinical environment the GP32 utilises a simple one button operation ensuring that even occasional users are able to quickly become accustomed to the machine. Integral cuff holder helps prevent cuffs and machine separation.

- Memory key for optional storage of readings.
- Extra large cuff and AC/DC transformer available as optional accessories
- Fully automatic operation
- Large desktop display
- Single key operation
- Large button
- Auto power off
- Low battery indicator
- Memory function
- Oscillometric
- Accuracy +/- 3mmHg
- 195l x 165w x 90d mm
- 620g weight
- 4 x AA batteries



Cuff storage compartment keeps everything tidy when not in use.

60.50.000		£35.20
Guardian Pro-Check GP32 digital clinical sphygmo		
60.40.000/1	Standard Cuff 22-34cm	£7.75
60.40.000/2	Large Cuff 32-42cm	£8.75

Guardian Pro-Check HU61M

Approved by the German Hypertension Society (GHS) HU61M provides superior accuracy and ease of use. With the six colour WHO blood pressure indicator all users can keep a track of their individual blood pressures. Readings can be averaged on an hourly, daily, weekly, monthly and overall basis. Four medication alarms and convenient clock showing date and time when not in operation.

For those individuals requiring blood pressure assessment on a regular basis HU61M is their ideal partner.



60.40.000		£39.30
Guardian Pro-Check HU61M digital clinical sphygmo		
60.40.000/1	Standard Cuff 22-34cm	£7.75
60.40.000/2	Large Cuff 32-42cm	£8.75

Your local medical supplier is just a phone call away. See cover for full details

Prices shown are exclusive of VAT and delivery

Guardian Self Test

- Simple, economically priced self test BP machine
- Individual dial and inflation systems
- Dial clips on to cuff for easy reading
- Includes stethoscope, attached to cuff for instant arterial placement
- Complete in pouch with full user instructions



55.09.113

Guardian Self Test sphygmo

£26.10

BoSo BS90



- Traditional self-test BP machine
- Aneroid principal with screw type air release
- Blue ABS casing and co-ordinated velcro cuff
- Large 60mm easy to read dial
- Stethoscope with cuff fastening for instant arterial location
- Complete with full user instructions and storage case

55.08.200

BoSo BS90 self test sphygmo

£50.00

BoSo Egotest

- Self-test manual BP monitor
- Automatic push-button air release
- Tough ABS construction
- Stethoscope with cuff fastening for instant arterial location
- Large 60mm dial
- Complete with full user instructions and storage case



54.08.110

BoSo Egotest self test sphygmo

£45.40

Your local medical supplier is just a phone call away. See cover for full details

Prices shown are exclusive of VAT and delivery

Blood Pressure 24 Hour BP Monitors

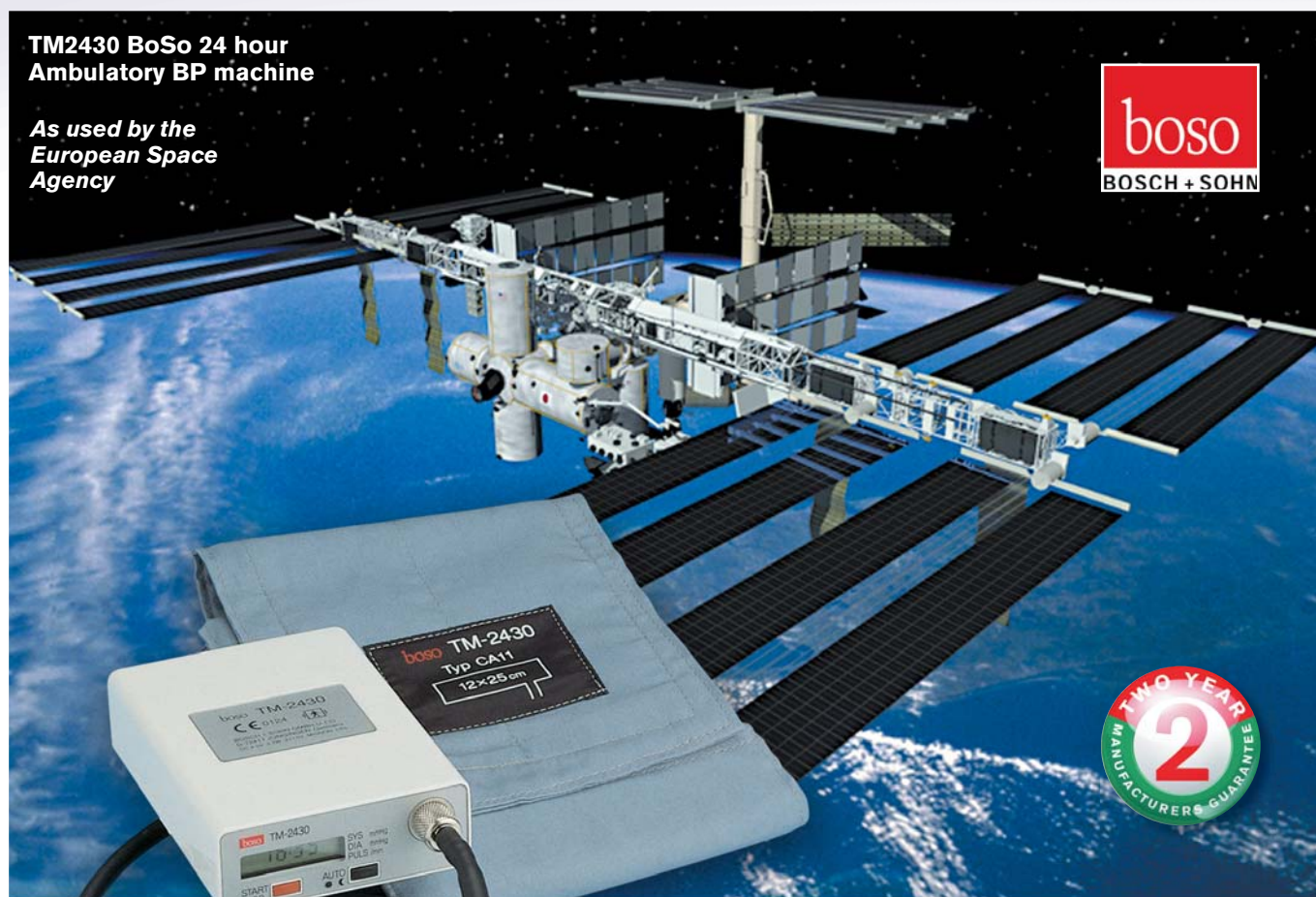

TM2430 BoSo 24 hour Ambulatory BP machine

As used by the European Space Agency



76



60.24.000 TM2430 24 hour ABPM, with PC control **£1250.00**

TM2430 BoSo 24 hour BP Monitor

- Lightweight and compact 24 hour ambulatory BP machine with PC control
- Oscillometric principal for consistent accuracy and performance
- Fully programmable from PC
- Automatic sleep function
- Powered from rechargeable NIMH accumulators (supplied)
- Stores up to 350 measurements
- Fast, reliable evaluation of patients data – plug in and go
- Create tables of pressure readings, display data and calculate mean arterial pressure, pulse and morning blood pressure surge
- Supplied in protective carrying case, with:
 - TM2430 PC, BP monitor
 - Adult velcro cuff, latex free
 - Hip case, belt strap, and shoulder strap
 - PC transmission pack and cable
 - Profile manager software
 - Accumulators and charger
 - Full user instructions
- Dimensions: 100 x 80 x 27mm
- Weight: 220gm
- 2 year warranty

24 hour BP Monitor – Spares & Accessories

For replacement or alternative size cuffs please see Section 3 on page 223

60.24.000/1	Child Cuff with inflation bag 95cm tubing	£139.00
60.24.000/2	Adult Cuff with inflation bag 120cm tubing	£139.00
60.24.000/3	Large Adult Cuff with inflation bag 130cm tubing	£139.00
60.24.000/5	Hip Case	£22.50
60.24.000/6	PC Transmission Box including D connector and jack plug	£65.00
60.24.000/7	Girdle	£32.00
60.24.000/8	Carrying Case	£44.10
60.24.000/10	Set of 3 Nmh rechargeable batteries	£35.00
60.24.000/21	Replacement Inflation Bag - Child	£56.95
60.24.000/22	Replacement Inflation Bag - Adult	£56.95
60.24.000/23	Replacement Inflation Bag - Large Adult	£56.95
60.24.000/31	Pack of 10 cloth cuff covers - Child	£44.10
60.24.000/32	Pack of 10 cloth cuff covers - Adult	£44.10
60.24.000/33	Pack of 10 cloth cuff covers - Large Adult	£44.10

Your local medical supplier is just a phone call away. See cover for full details

Prices shown are exclusive of VAT and delivery

Spares and Cuffs Blood Pressure

Should the required accessory not be listed, please call the order line, where our trained advisors will be happy to assist you with the item you require.

- Note: i For digital BP monitor cuffs, please refer to the correct product listing earlier in this section.
 ii Individual Boso cuffs and bladders, inflation bulbs, valves and other accessories are available on request

Please call for further details.

Section 1: For BoSo Clinicus, Profitest, Varius, Roid, Solid, Guardian Pro Berlin, Guardian Pro Europa, AW Clip On, Heine Gamma G5, G7 and GP

311-4-400	Neonatal (multi-colour) 4 x 20cm (circ. < 8cm)	£16.85
311-4-350	Infant (multi-colour) 6 x 34cm (circ. < 8cm)	£16.85
211-4-310	Toddler (multi-colour) 6.5 x 28cm (circ. 8 – 13cm)	£16.85
211-4-300	Child (multi-colour) 10 x 34cm (circ. 14 – 21cm)	£16.85

Section 2: BoSo Classico and Classic

211-4-303	Child (black) 8 x 20cm (circ. 14 – 21cm)	£20.95
111-4-252	Adult (black) 12 x 23cm (circ. 22 – 32cm)	£20.95
111-4-111	Adult large (black) 12 x 35cm (circ. 33 – 41cm)	£23.50

- Note: i Twin-tube versions of the above cuffs are available for the Boso Rapid on request.
 ii These Boso cuffs are push-on tube fitting and will fit most aneroid BP monitors with a male connector

111-4-100	Adult (black) 14 x 53cm (circ. 22 – 32cm)	£16.85
111-4-255	Adult (black / red) 14 x 53cm (circ. 22 – 32cm)	£16.85
111-4-130	Adult large (black) 15 x 64cm (circ. 33 – 41cm)	£19.90
111-4-210	Thigh (black) 20 x 86cm (circ. > 41cm)	£42.35

We are pleased to offer the following services to ensure the ongoing accuracy and performance of your blood pressure apparatus:

- Calibration and accuracy validation
- Servicing and Repair
- Parts replacement

Please call for further details



TM2430



BoSo

Section 3: For TM2430 BoSo 24hr Blood Pressure Monitor

60.24.000/1	Child size cuff	£139.00
60.24.000/2	Adult size cuff	£139.00
60.24.000/3	Outsize adult size cuff	£139.00
60.24.000/10	Set of 3 NMH rechargeable batteries for ABPM	£35.00

Section 4: For Nova S and Guardian Pro Large Dial Units

121-4-120	Adult 14 x 53cm (circ. 22 - 32cm)	£22.80
121-4-250	Adult (black) 14 x 53cm (circ. 22 - 32cm)	£19.25
121-4-130	Large Adult 15 x 64cm (circ. 33 - 41cm)	£25.30
121-4-210	Adult X Large 16 x 66cm (circ. 33 - 41cm)	£42.50
121-4-200	Thigh 20 x 86cm (circ. >41cm)	£37.00

General sphygmomanometer accessories

57.50.020	AW inflation bulb	£3.40
57.50.021	Air control valve, metal	£3.10
57.50.030	Zip fastening pouch, standard	£12.30
57.50.035	Zip fastening pouch, large	£12.30

Your local medical supplier is just a phone call away. See cover for full details

Prices shown are exclusive of VAT and delivery

Stethoscopes GP Stethoscopes

Littmann Master Classic II

- Tuneable diaphragm for high and low frequencies
- Single side chest piece
- High performance single lumen tubing
- Non chill ring
- 3 year warranty
- 69cm tubing

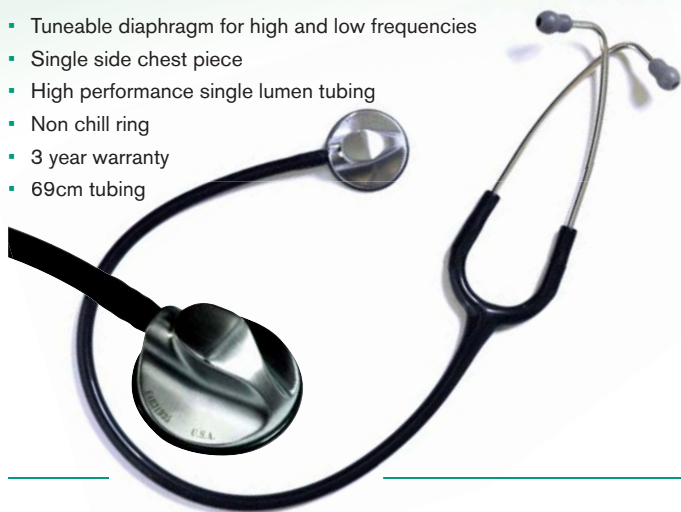

L2144L	Littmann Master Classic II, Black tubing	£77.00
L2143	Littmann Master Classic II, Purple tubing	£77.00
L2146	Littmann Master Classic II, Burgundy tubing	£77.00
L2147	Littmann Master Classic II, Navy Blue tubing	£77.00
L2630	Littmann Master Classic II, Caribbean Blue tubing	£77.00
L2632	Littmann Master Classic II, Hunter Green tubing	£77.00
L2633	Littmann Master Classic II, Ceil Blue tubing	£77.00
L2634	Littmann Master Classic II, Pine Green tubing	£77.00

Special Editions

L2141	Littmann Master Classic II, all Black finish	£77.00
--------------	--	---------------

80.20.000-02	Guardian Spirit Master GP stethoscope, Black tubing	£47.00
80.20.000-01	Guardian Spirit Master GP stethoscope, Grey tubing	£47.00
80.20.000-03	Guardian Spirit Master GP stethoscope, Hunter Green tubing	£47.00
80.20.000-07	Guardian Spirit Master GP stethoscope, Dark Blue tubing	£47.00
80.20.000-10	Guardian Spirit Master GP stethoscope, Burgundy tubing	£47.00
80.20.000-13	Guardian Spirit Master GP stethoscope, Ceil Blue tubing	£47.00
80.20.000CP	Guardian Spirit Master GP stethoscope, all Black version	£47.00
80.20.000GP	Guardian Spirit Master GP stethoscope, Gold plated version	£47.00

Guardian Spirit Master GP Stethoscope

- Tuneable pressure sensitive diaphragm for high and low frequencies
- Single side chest piece
- High performance single lumen tubing
- Non chill ring
- 3 year warranty
- 69cm tubing



Guardian Spirit Sprague Interchange

- Cardiology quality stethoscope with unique interchangeable diaphragm chestpieces and bells providing suitability for Child and Adult use.
- Tuneable pressure sensitive diaphragm for high and low frequencies
- 3 year warranty
- 69cm tubing

80.16.000-01	Guardian Spirit Sprague, Grey tubing	£69.40
80.16.000-02	Guardian Spirit Sprague, Black tubing	£69.40
80.16.000-03	Guardian Spirit Sprague, Dark Green tubing	£69.40
80.16.000-05	Guardian Spirit Sprague, Royal Blue tubing	£69.40
80.16.000-07	Guardian Spirit Sprague, Dark Blue tubing	£69.40
80.16.000-10	Guardian Spirit Sprague, Burgundy tubing	£69.40
80.16.000-16	Guardian Spirit Sprague, Red tubing	£69.40
80.16.000-21	Guardian Spirit Sprague, Navy Blue tubing	£69.40



Your local medical supplier is just a phone call away. See cover for full details

Prices shown are exclusive of VAT and delivery

Littmann Classic II SE Stethoscope

- The standard stethoscope of the healthcare professional worldwide.
- Dual frequency diaphragm
- Stainless steel chestpiece
- 28" tubing with integral headframe
- 3 year warranty
- Wide variety of colours available

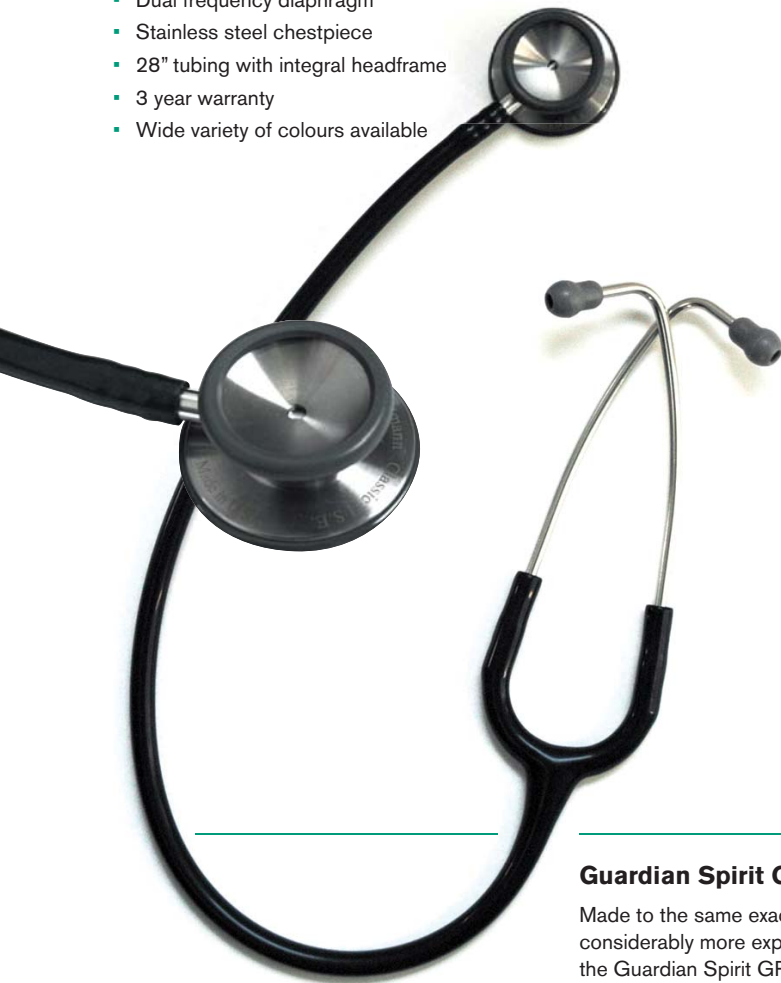

L2201	Littmann Classic II SE, Black tubing	£58.25
L2203	Littmann Classic II SE, Grey tubing	£58.25
L2205	Littmann Classic II SE, Navy Blue tubing	£58.25
L2206	Littmann Classic II SE, Caribbean Blue tubing	£58.25
L2208	Littmann Classic II SE, Hunter Green tubing	£58.25
L2209	Littmann Classic II SE, Purple tubing	£58.25
L2210	Littmann Classic II SE, Raspberry tubing	£58.25
L2211	Littmann Classic II SE, Burgundy tubing	£58.25
L2813	Littmann Classic II SE, Ceil Blue tubing	£58.25
L2812	Littmann Classic II SE, Orange tubing	£58.25
L2816	Littmann Classic II SE, Pink tubing	£58.25
L2817	Littmann Classic II SE, Bubblegum Pink tubing	£58.25
L2818	Littmann Classic II SE, Pine Green tubing	£58.25
L2819	Littmann Classic II SE, Ocean Blue tubing	£58.25
L2822	Littmann Classic II SE, Peach tubing	£58.25

Special Finishes

L2218BE	All Black edition	£58.25
L2820	CPR Copper version	£58.25
L2823	Rainbow	£58.25
L2201BRS	Brass	£58.25
L2827SM	Smoke, Black tubing	£58.25
L2829RBW	Rainbow	£58.25
L2941	Smoke, Sand tubing	£58.25
L2942	Smoke, Dark olive tubing	£58.25

Guardian Spirit GP

Made to the same exacting standards as considerably more expensive stethoscopes the Guardian Spirit GP is ideal for those practitioners requiring a high quality stethoscope with excellent sound transmission at a reasonable price.

- Dual frequency diaphragm
- Stainless steel chest piece, adult
- 28" tubing with integral head frame
- Spare ear tips
- 3 year warranty
- Wide variety of colours available with some unique variations
- For paediatric, infant or neonatal size, please see [page 86](#)



80.05.000BLACK	Guardian Spirit GP Stethoscope, Black tubing	£33.20
80.05.000BLUE	Guardian Spirit GP Stethoscope, Blue tubing	£33.20
80.05.000BURGUN	Guardian Spirit GP Stethoscope, Burgundy tubing	£33.20
80.05.000GREEN	Guardian Spirit GP Stethoscope, Green tubing	£33.20
80.05.000GREY	Guardian Spirit GP Stethoscope, Grey tubing	£33.20
80.05.000RED	Guardian Spirit GP Stethoscope, Red tubing	£33.20
80.05.000-13	Guardian Spirit GP Stethoscope, Ceil Blue tubing	£33.20
80.05.000-24	Guardian Spirit GP Stethoscope, Frosted Seafoam tubing	£33.20
80.05.000-27	Guardian Spirit GP Stethoscope, Frosted Lilac tubing	£33.20
80.05.000-29	Guardian Spirit GP Stethoscope, Frosted Bubblegum pink tubing	£33.20

Your local medical supplier is just a phone call away. See cover for full details

Prices shown are exclusive of VAT and delivery

Stethoscopes Cardiology Stethoscopes

3M™ Littmann™ Master Cardiology Stethoscope

- The ultimate acoustic stethoscope
- Unique patented single-sided design
- Clinician monitors both high and low frequency sound by simply alternating pressure on the chestpiece
- Accurate and efficient auscultation
- 27" tubing and integral headframe
- Supplied in attractive presentation box with accessories
- Seven year warranty



L2160 Master Cardiology Stethoscope, Black	£171.00
L2161 Master Cardiology Stethoscope, All Black edition	£171.00
L2163 Master Cardiology Stethoscope, Burgundy	£171.00
L2164 Master Cardiology Stethoscope, Navy Blue	£171.00
L2167 Master Cardiology Stethoscope, Plum	£171.00

L2165 Master Cardiology Stethoscope, Hunter Green	£171.00
L2175 Master Cardiology Stethoscope, Brass edition	£171.00
L2176 Master Cardiology Stethoscope, Smoke edition	£171.00
L2178 Master Cardiology Stethoscope, Caribbean Blue	£171.00

Guardian Spirit SHC Stethoscope

- Single head cardiology chest piece with pressure sensitive diaphragm
- Ergonomic head design reduces extraneous external noise and provides superb acoustics
- Adjust pressure to alternate between high and low frequency sounds
- Soft seal ear tips
- 10 year warranty

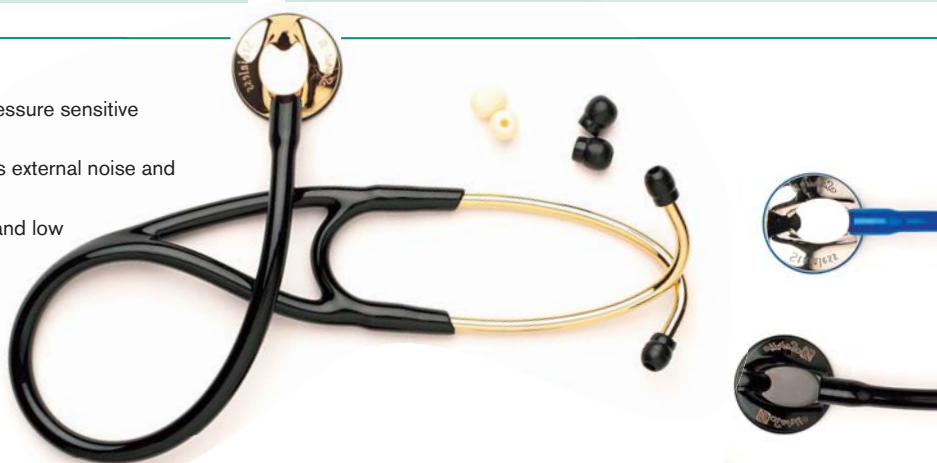

80.10.000-01 Guardian Spirit Cardiology SHC, Grey tubing	£104.50
80.10.000-02 Guardian Spirit Cardiology SHC, Black tubing	£104.50
80.10.000-03 Guardian Spirit Cardiology SHC, Hunter Green tubing	£104.50
80.10.000-05 Guardian Spirit Cardiology SHC, Royal Blue tubing	£104.50

80.10.000-07 Guardian Spirit Cardiology SHC, Dark Blue tubing	£104.50
80.10.000-10 Guardian Spirit Cardiology SHC, Burgundy tubing	£104.50
80.10.000-16 Guardian Spirit Cardiology SHC, Red tubing	£104.50
80.10.000-21 Guardian Spirit Cardiology SHC, Navy Blue tubing	£104.50

Littmann Cardiology STC

- The Littmann Soft Touch Chestpiece provides Cardiology grade acoustics in a single sided chestpiece
- The unique soft-touch insert greatly improves ergonomics and reducing noise and providing superior acoustics
- Move between high and low frequency sounds by increasing and decreasing pressure on the chestpiece
- Littmann soft sealing eartips
- 6 year warranty
- Available in black, blue or burgundy

L4471 Littmann Cardiology STC, Black	£170.00
L4472 Littmann Cardiology STC, Burgundy	£170.00
L4473 Littmann Cardiology STC, Navy Blue	£170.00
L4475 Littmann Cardiology STC, Plum	£170.00



Your local medical supplier is just a phone call away. See cover for full details

Prices shown are exclusive of VAT and delivery

Cardiology Stethoscopes Stethoscopes

Littmann™ Cardiology III Stethoscope



- Littmann, dual patented tuneable diaphragm design
- Low and high frequency sounds can be monitored by alternating pressure on the chestpiece
- Large diaphragm is used for adults and the small diaphragm is ideal for paediatric or thin patients
- Versatile and accurate for efficient auscultation
- 27" tubing and integral headframe
- Supplied in attractive presentation box with accessories.
- 5 year warranty



L3128 Littmann Dual/Cardiology III, Black	£147.00
L3129 Littmann Dual/Cardiology III, Burgundy	£147.00
L3130 Littmann Dual/Cardiology III, Navy Blue	£147.00
L3135 Littmann Dual/Cardiology III, Plum	£147.00

L3134 Littmann Dual/Cardiology III, Hunter Green	£147.00
L3136 Littmann Dual/Cardiology III, Grey	£147.00
L3137 Littmann Dual/Cardiology III, Chocolate	£147.00

80.09.000-01	£98.00
Guardian Spirit Cardiology with Grey tubing	
80.09.000-02	£98.00
Guardian Spirit Cardiology with Black tubing	
80.09.000-03	£98.00
Guardian Spirit Cardiology with Hunter Green tubing	
80.09.000-05	£98.00
Guardian Spirit Cardiology with Royal Blue tubing	
80.09.000-07	£98.00
Guardian Spirit Cardiology with Dark Blue tubing	
80.09.000-10	£98.00
Guardian Spirit Cardiology with Burgundy tubing	
80.09.000-16	£98.00
Guardian Spirit Cardiology with Red tubing	
80.09.000-21	£98.00
Guardian Spirit Cardiology with Navy Blue tubing	

Guardian Spirit Cardiology

- Cardiology stethoscope with pressure sensitive diaphragms
- Large diaphragm for adult use, smaller diaphragm for paediatric use
- Optional screw on bell for versatility
- Integral headframe
- Durable Stainless steel chest piece
- Soft seal ear tips
- 10 year warranty
- 8 colours available



BoSo Cardioscope

With over 50 years of experience manufacturing the highest quality BP monitors and stethoscopes Bosch and Sohn of Jungingen, Germany are recognised as producing some of the finest medical equipment available. The Cardioscope provides the very best in quality at a very reasonable price.

- Cardiology stethoscope with adult diaphragm and bell chestpiece
- Integral headframe
- Durable Stainless steel chest piece
- Soft seal ear tips
- 10 year warranty
- Available in Black or Pink tubing



010.00.000Black	BoSo Cardioscope Black	£89.00
010.00.000Pink	BoSo Cardioscope Pink	£89.00

Your local medical supplier is just a phone call away. See cover for full details

Prices shown are exclusive of VAT and delivery

Stethoscopes Nursing & Child Friendly Stethoscopes

Littmann Lightweight II SE

- The 3M Littmann Lightweight II SE is a general purpose stethoscope with an improved design that provides reliable acoustics for basic blood pressure and limited physical assessment.
- It has a chestpiece shape designed for better orientation around blood pressure cuffs and body contours.
- In addition, this stethoscope has a two sided chestpiece; a traditional bell on the smaller side and the 3M Littmann tunable diaphragm on the larger side of the chestpiece.
- The 3M Littmann tunable diaphragm conveniently alternates between high and low frequency sounds without the need to turn over the chestpiece and reposition the stethoscope. Use firm pressure with the tunable diaphragm to listen to the high frequencies and use light pressure to listen to the low frequencies.
- The Lightweight II comes with the patented 3M Littmann snap tight soft-sealing eartips that create an excellent acoustic seal to reduce ambient noise as well as providing a comfortable fit.
- This stethoscope is available in a wide range of colours and comes with a two year warranty backed by the exceptional service and quality of 3M Littmann.



LS2450 Littmann Lightweight II with Black tubing	£24.95
LS2451 Littmann Lightweight II with Burgundy tubing	£24.95
LS2452 Littmann Lightweight II with Caribbean Blue tubing	£24.95
LS2453 Littmann Lightweight II with Lilac tubing	£24.95
LS2454 Littmann Lightweight II with Ceil Blue tubing	£24.95
LS2455 Littmann Lightweight II with Seafoam Green tubing	£24.95
LS2456 Littmann Lightweight II with Pink tubing	£24.95

Guardian Spirit Advanced Nursing Stethoscope



With its tunable diaphragm the Advanced is a superb stethoscope for all nursing applications

The novel oval shaped chestpiece allows easier use around blood pressure cuffs and the comfortable ear tips provide a good acoustic seal.

An excellent value for money alternative for those who appreciate value for money

80.25.000-01 Guardian Advanced with grey tubing	£19.40
80.25.000-04 Guardian Advanced with pink tubing	£19.40
80.25.000-07 Guardian Advanced with dark blue tubing	£19.40
80.25.000-10 Guardian Advanced with burgundy tubing	£19.40
80.25.000-13 Guardian Advanced with ceil blue tubing	£19.40

Guardian Spirit Nurses Scopes

A range of high quality single sided stethoscopes ideal for all nursing requirements

Single side chest piece with sound centraliser to enhance the sound frequency of both heart and lung



PRF
Stethoscope

£24.50

Your local medical supplier is just a phone call away. See cover for full details

Prices shown are exclusive of VAT and delivery

Nursing & Child Friendly Stethoscopes Stethoscopes

3M™ Littmann™ Select Stethoscope



- Designed to meet nurses and technicians daily auscultation needs
- Single sided listening for high and low frequencies
- Adjustable integral headframe and tubing
- Soft sealing ear tips
- Supplied in presentation box
- 2 year warranty

L2290	£37.00
Littmann Select Stethoscope, Black	
L2296	£37.00
Littmann Select Stethoscope, Raspberry	
L2301	£37.00
Littmann Select Stethoscope, Ceil Blue	
L2305	£37.00
Littmann Select Stethoscope, Pine Green	
L2306	£37.00
Littmann Select Stethoscope, Ocean Blue	
L2310	£37.00
Littmann Select Stethoscope, Peach	

Guardian Spirit Nurse

- Superb acoustic quality in a value for money package
- Single sided chestpiece with pressure sensitive floating diaphragm
- Adjustable headframe
- 2 year warranty



80.24.000-04	£29.60
Guardian Spirit Nurse scope with pink tubing	
80.24.000-07	£29.60
Guardian Spirit Nurse scope with dark blue tubing	
80.24.000-14	£29.60
Guardian Spirit Nurse scope with magenta tubing	
80.24.000-27	£29.60
Guardian Spirit Nurse scope with frosted lilac tubing	

Your local medical supplier is just a phone call away. See cover for full details

Prices shown are exclusive of VAT and delivery

Stethoscopes Nursing & Child Friendly Stethoscopes

Child Friendly Stethoscopes

Sister Sunshine Smiley Face

Make your patients smile and your colleagues laugh when you use Sister Sunshine Yellow Smiley face. Sound centralising chest piece for high quality sound reproduction. Only available with Sunshine Yellow tubing and Sunshine Yellow Smiley Face



SSSF Sister Sunshine Smiley Face stethoscope **£24.50**

Sister Sunshine Animals

Sister Sunshine also loves animals and you can choose from any of those shown opposite.

- With deluxe head frame and high performance chest piece this stethoscope is ready for any duty.
- Supplied with complete set of 7 interchangeable heads



SSA-06 Sister Sunshine stethoscope - yellow tubing **£24.50**
SSA-18 Sister Sunshine stethoscope - blue tubing **£24.50**
SSA-19 Sister Sunshine stethoscope - pink tubing **£24.50**

AW Monoscope

- Single sided chestpiece for blood pressure testing
- Adjustable headframe with external spring
- Colours: Black, Blue, Burgundy, Green, Grey or Red



90.05.000 **£7.20**
 AW Monoscope (please state colour req.)

AW Duoscope

- Double sided chestpiece for general use
- Adjustable headframe with external spring
- Colours: Black, Blue, Burgundy, Green, Grey or Red



90.01.000 **£8.70**
 AW Duoscope (please state colour req.)

Your local medical supplier is just a phone call away. See cover for full details
 Prices shown are exclusive of VAT and delivery

Electronic Stethoscopes Stethoscopes

3M Littmann Electronic Stethoscope Model 3200 with Bluetooth



- Reduces distracting room noise by an average of 85%
- Amplification and filtering system picks up difficult-to-hear heart and body sounds
- Easy use with infants and paediatric patients
- Ergonomic chestpiece for one hand manipulation
- Non chill diaphragm for patient comfort
- Operates on single AA (alkaline or lithium) battery
- Low battery warning
- Up to 24x sound amplification
- 2 year guarantee
- Recording and playback functions
- Can record and playback in the stethoscope
- Supplied with PC compatible Bluetooth dongle
- Zargis Steth Assist visualization software
- Recordings can be sent to colleagues or attached to patient records

L3200BK27 Littmann Electronic Stethoscope Black Model 3200	£324.00
L3200BU Littmann Electronic Stethoscope Burgundy Model 3200	£324.00
L3200NB Littmann Electronic Stethoscope Navy Blue Model 3200	£324.00

3M Littmann Electronic Stethoscope Model 3100



- Reduces distracting room noise by an average of 85%
- Amplification and filtering system picks up difficult-to-hear heart and body sounds
- Ergonomic chestpiece for one hand manipulation
- Non chill diaphragm for patient comfort
- Operates on single AA (alkaline or lithium) battery
- Low battery warning
- Up to 24x sound amplification
- 2 year guarantee

L3100BK27 Littmann Electronic Stethoscope Black Model 3100	£262.00
L3100BU Littmann Electronic Stethoscope Burgundy Model 3100	£262.00
L3100NB Littmann Electronic Stethoscope Navy Blue Model 3100	£262.00

Guardian Spirit Pro-Sound



- The value for money alternative with superb acoustic features and build quality
- Precision electronic stethoscope
- 3 function selection of Bell – Diaphragm and Wide Range to enhance sound of heart and lung
- Sound Analysis Software supplied – displays frequency to help accurate and precise diagnosis
- Rechargeable Li-Ion battery
- Simple and reliable to use

CK-E600A Guardian CK-E600 Precision electronic stethoscope with SAS software	£232.50
---	----------------

Your local medical supplier is just a phone call away. See cover for full details

Prices shown are exclusive of VAT and delivery

Stethoscopes Paediatric and Infant Stethoscopes

3M™ Littmann™ Classic II S.E. Stethoscope Paediatric and Infant



For Adult versions of the Classic II S.E. stethoscope please see page 79

- The standard of the healthcare professional worldwide
- Incorporates the Littmann dual frequency diaphragm
- 28" tubing with integral adjustable headframe
- Available in paediatric and infant versions
- Supplied in presentation box
- 3 year warranty



L2113 Littmann Classic II S.E. Paediatric Black	£67.00
L2123 Littmann Classic II S.E. Paediatric Navy Blue	£67.00
L2122 Littmann Classic II S.E. Paediatric Raspberry	£67.00
L2131 Littmann Classic II S.E. Paediatric Pine Green	£67.00
L2113R Littmann Classic II S.E. Paediatric Red	£67.00
L2153 Littmann Classic II S.E. Paediatric Rainbow edition	£67.00
L2136 Littmann Classic II S.E. Paediatric Royal Blue	£67.00
L2154 Littmann Classic II S.E. Paediatric Peach	£67.00
L2155 Littmann Classic II S.E. Paediatric Orange	£67.00

L2114BLK Littmann Classic II S.E. Infant Black	£67.00
L2124 Littmann Classic II S.E. Infant Caribbean Blue	£67.00
L2125 Littmann Classic II S.E. Infant Raspberry	£67.00
L2114R Littmann Classic II S.E. Infant Red	£67.00
L2157 Littmann Classic II S.E. Infant Rainbow edition	£67.00
L2156 Littmann Classic II S.E. Infant Royal Blue	£67.00
L2158 Littmann Classic II S.E. Infant Peach	£67.00
L2179 Littmann Classic II S.E. Infant Orange	£67.00

Guardian Spirit GP

Made to the same exacting standards as considerably more expensive stethoscopes the Guardian Spirit GP is ideal for those practitioners requiring a high quality stethoscope with excellent sound transmission at a reasonable price.

- Dual frequency diaphragm
- Stainless steel chest piece, paediatric, infant or neonatal size
- 28" tubing with integral head frame
- Spare ear tips
- 3 year warranty



80.06.000 AW Spirit stethoscope, paediatric. Black, blue burgundy, green, grey or red tubing	£38.80
80.07.000 AW Spirit stethoscope, infant. Burgundy, green, grey or red tubing	£38.80
80.08.000 AW Spirit stethoscope, neonatal. Grey tubing only	£38.80

Pinard Foetal Stethoscopes



90.06.000 AW Pinard Foetal Stethoscope, plastic	£6.40
90.06.005 AW Pinard Foetal Stethoscope, wooden	£7.40
90.07.000 AW Pinard Foetal Stethoscope, aluminium	£6.40

Your local medical supplier is just a phone call away. See cover for full details

Prices shown are exclusive of VAT and delivery

Disposable, Twin Tube, Littmann Accessories Stethoscopes

Guardian Spirit Disposable

Ideal for uses where cross contamination may be an issue or where bodily fluids may be present

- Single patient use
- Cost effective



80.30.000-16	£2.80
Guardian disposable with red tubing	
80.30.000-05	£2.80
Guardian disposable with blue tubing	

AW Sprague Rappaport

- Twin tube stethoscope for stereo auscultation
- Dual sided chestpiece, complete with 3 bell adaptors (sml, med and large)
- Mushroom ear tips, comfortable to wear
- Adjustable headframe with external spring
- Supplied in display box
- 12 month warranty



80.15.000	£13.30
AW Sprague Rappaport stethoscope	

80.15.000-02	£13.30
with black tubing	
80.15.000-03	£13.30
with hunter green tubing	
80.15.000-05	£13.30
with royal blue tubing	
80.15.000-06	£13.30
with yellow tubing	

80.15.000-10	£13.30
with burgundy tubing	
80.15.000-17	£13.30
with purple tubing	
80.15.000-23	£13.30
with seafoam green	
80.15.000-30	£13.30
with frosted purple tubing	

Littmann Accessories

Diaphragms

CA/CLD	Cardiology II, Classic II	£2.84
CLPD	Paediatric Classic II	£2.16
CLID	Infant Classic II	£2.16
CL31/D	3100 Electronic	£6.70
32D/B	3200 Electronic	£6.70
CL30/D	3000 Electronic	£6.18

Tuneable Rim & Diaphragm assembly

MCD/G	Master Cardiology, grey	£7.74
MCD/B	Master Cardiology, black	£7.74
SED/G	Master Classic II, Select, Cardiology II SE, and Classic II SE, grey	£6.44
SED/B	Master Classic II, Select, Cardiology II SE, and Classic II SE, black	£6.44

Snap on Rims

SOR/B	Cardiology II and Classic II, black	£2.27
SOR/G	Cardiology II and Classic II, grey	£2.27
SORP/B	Paediatric, black	£2.38
SORP/G	Paediatric, grey	£2.38
SORI/B	Infant, black	£2.38
SORI/G	Infant, grey	£2.38

Non-Chill Sleeves

NCCA	Cardiology II and Cardiology II SE	£3.04
NCCL	Classic II and Classic II SE	£3.04
NCP	Paediatric	£2.94
NCI	Infant	£2.94

Ear Tips push-on

EARSR/S	Firm grey, small pair	£3.76
EARSR/L	Firm grey, large pair	£3.76
SSRGS	Soft sealing, small grey pair	£5.00
SSRGL	Soft sealing, large grey pair	£5.00
SSRBS	Soft sealing, small black pair	£5.00
SSRBL	Soft sealing, large black pair	£5.00

Your local medical supplier is just a phone call away. See cover for full details

Prices shown are exclusive of VAT and delivery

General Diagnostics Thermometers

AW Infrared Ear Thermometer

- Safe, fast and accurate readings
- Super responsive one second measurement
- Memory recalls last 10 readings
- Automatic one minute shut off
- Simply press start for immediate reading
- Soft operation keys
- Measurement temperature range:
35.5 – 42.0 C (95.5 – 107.6F)
- High/Low indication if measurement outside range
- Accuracy +/-0.2C



96.26.000 AW Infrared Ear Thermometer **£20.40**

96.26.100 Disposable Probe Covers (Pack of 20) **£1.50**

88

Guardian Digital Thermometer

- Rapid 10 second reading
- Patient friendly flexible probe
- Waterproof
- Large easy to read display
- Peak hold and auto shut off function
- Last temperature recall
- Audible completion signal
- 32-42 C (89.6-107.6F) measurement range
- High/Low indication if measurement outside range
- Accuracy +/-0.1C



96.21.060
Guardian Digital Thermometer

£4.10

AW Digital Thermometer, with audible alert

- Compact, accurate and reliable thermometer with digital display
- Available in celsius only
- Audible alert indicates when reading complete
- Measurement time approx 30 secs when taken orally
- 32°C to 42°C temperature range
- Accurate to within +/- 0.1°C from 34°C to 40°C
- Includes plastic storage case and full instructions
- Dimensions 11x 18 x 130mm; weight 10gms approx



96.21.000 AW Digital Celsius Thermometer

£5.40

Your local medical supplier is just a phone call away. See cover for full details
Prices shown are exclusive of VAT and delivery

Braun Thermoscan IRT4520

- **ExacTemp Technology** – measures the temperature of heat from the ear drum and surrounding tissue
- **Fast and Accurate** – reliable results in seconds
- **Suitable for All Ages**
- **Thermoscan Feedback System** – ensures correct positioning of the thermometer for an accurate reading
- **Flexible Tip** – reduces patient discomfort
- **Disposable Probe Covers** – reducing the risk of cross-contamination
- **8 Memory Function**

Package Includes:

- Thermoscan with case and lens cover
- Lithium batteries
- 21 disposable probe covers
- User instruction manual



Probe Covers

- **Single-Use Probe Covers** – reduced risk of cross contamination
- **Dispenser Pack** – of 10 x 20 probe covers (200)
- **Suitable for Braun and Welch Allyn Thermometers**
- **Guardian Pro-cover independently tested for accuracy of readings with Braun IRT4520 thermometer.**

Details available on request.



PC200 £13.80
Thermoscan Probe Covers x 200

Guardian Probe Cover £10.80
PC200/Gen probe covers for Braun IRT4520

IRT4520 Braun IRT4520 £39.95

ZEAL Single-Use Clinical Thermometer



- **Hygienic Clinical Thermometer** – for single patient use
- **Safe** – no risk of cross-contamination
- **Easy** – place the thermometer for the required time and read from the temperature scale
- **Sterile** – individually sterile packed
- **Supplied in Packs of 100**

ZEAL100 £19.40
Zeal single-use thermometers x 100



As one of Europe's largest BP manufacturers BoSo are pleased to offer an ancillary range of high quality thermometers providing the precision required by the medical profession.

BoSo Therm flex

- Anti-allergenic gold coating
- Flexible tip for gentle measurement
- 100% waterproof
- Memory of last measurement
- Handy transparent case



521-0-021 £6.65
BoSo Therm Flexible tip digital thermometer

BoSo Therm medical GP

- Infrared-Ear-Thermometer for precise measurement in only 1 second
- Clear, illuminated display
- Fever alarm
- Memory
- Beep for beginning and ending

521-0-019 £43.00
BoSo Therm medical GP Infrared ear thermometer

520-7-086 £10.85
Lens covers for bosotherm medical, pack of 40



Your local medical supplier is just a phone call away. See cover for full details
Prices shown are exclusive of VAT and delivery

General Diagnostics **Measuring**

AW Thermometer Area Temperature Measurement

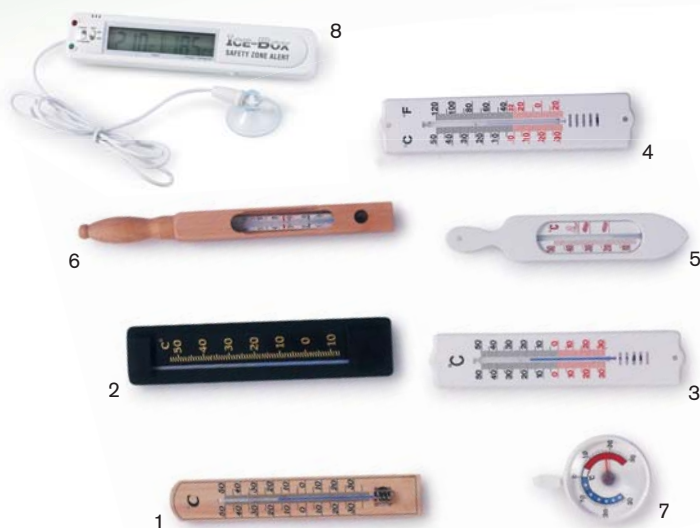

96.17.000	Wooden frame wall thermometer, dual celsius (fig.1)	£8.20
96.17.050	Black plastic room thermometer 7°C to 50°C (fig.2)	£4.90
96.16.000	Plastic framed wall thermometer, celsius only (fig.3)	£4.90
96.15.000	Plastic framed wall thermometer, dual graduated (fig.4)	£4.90
96.18.000	Floating bath thermometer (fig.5)	£6.90
96.18.050	Wooden bath thermometer "peg" design (fig.6)	£8.00
96.19.000	Fridge thermometer with dial (fig.7)	£6.10
96.22.000	Digital thermometers, for display of internal fridge temp (fig.8)	£24.50

Stainless Steel Rulers

Graduated in mm and inches these rulers are ideal for measurement of lesions etc. All sizes can be sterilised by autoclaving.

20X-00011	15cm/6"	Without sizing holes	£5.25
24.032.20	20cm/8"	Without sizing holes	£5.25
17.418.30	30cm/12"	Without sizing holes	£4.80
17.418.50	50cm/20"	Without sizing holes	£9.00
17.422.15	15cm/6"	With sizing holes	£27.10



17.422.15

Cloth Tape Measure, 1.5M (60 inches)

- Dual graduated in millimetres and inches
- Self retracting oil cloth tape measure
- Plastic bodied



17.427.15 Cloth tape measure **£6.90**

Townley Measuring Calliper

Townley measuring Calliper graduated in mm and inches

- For internal and external measurements
- 11.5cm/4.5"



17.409.01 Townley measuring Calliper **£178.50**

Internal and External Calliper

Internal and external Calliper for measuring up to 20cm/8"



16X-00210 Internal and external Calliper **£66.30**

Your local medical supplier is just a phone call away. See cover for full details

Prices shown are exclusive of VAT and delivery

AW Disposable Pentorch

- Sealed cell pocket torch
- Gives many weeks illumination when used daily
- Pocket clip also controls illumination
- Store in a cold place for long life
- Available with cobalt blue filter for Fluoroscein examinations



95.01.000	Disposable Pentorch, each	£2.60
95.01.000/6	Disposable Pentorch, pack of 6	£13.40
95.02.010	Disposable Pentorch with blue filter, pack of 3	£14.80
95.02.010/1	Blue top only	£2.00

AW Re-useable Pentorch



- All features as the AW disposable torch but with replaceable batteries
- Takes 2 x AAA batteries (1 set supplied)

95.02.000	Re-useable Pentorch, each	£3.10
95.02.000/6	Re-useable Pentorch, pack of 6	£17.40

AW Spirit Pentorch



- AW Spirit Pentorch with optional domicillary aural adaptor
- Chrome exterior finish with measuring scale and pupil size gauge
- High light output, powered from 2 x AAA batteries (not supplied)
- Pocket clip on/off control
- Domicillary pack includes pentorch with aural adaptor, 3 speculum and compact case

95.03.150	AW Spirit Pentorch with domicillary pack	£19.40
------------------	--	---------------

Premium Reusable Pen Torches

- Lightweight, sturdy metal casings
- Push button switch
- Pocket clip
- Available in silver, black, pink, green and yellow. Please state colour when ordering
- Supplied with 2 x AAA batteries



95.03.170	Premium Reusable Pen Torches	£5.99
------------------	------------------------------	--------------

Your local medical supplier is just a phone call away. See cover for full details

Prices shown are exclusive of VAT and delivery

General Diagnostics Percussors

Percussors

92.03.000	National Hospital (Queens Square) Percussor, nylon handle 32.5cm (13")	£6.20
92.03.100	Telescopic Queens Square Percussor 15cm/34cm (6"/13.5") extended	£19.40
92.04.000	Babinski Percussor, nylon handle 25cm (10")	£6.10
92.01.000	Vernon Ball Head Percussor, nylon handle 25cm (10")	£6.10
92.05.000	Buck Percussor 17.5cm (7") with pin and brush	£14.10
92.06.000	Buck Telescopic Percussor with pin and brush ends	£14.80
92.07.000	Taylor Model USA Percussor 20cm (8")	£10.80
92.10.000	Wartenberg Pin Wheel, sensitivity testing (autoclavable)	£70.40



17-400-01

17-400-01 **£145.70**
Vigorimeter. Used for pressure testing of patient grip strength. Includes 3 sizes of rubber bulbs and supplied in plastic storage box



Your local medical supplier is just a phone call away. See cover for full details
Prices shown are exclusive of VAT and delivery

Silicone Fob Watches

Ideal for healthcare professionals and nurses

- Lightweight but durable silicone body
- Dial pops out of silicone body enabling both items to be effectively cleaned
- Analogue dial face
- Available in blue, orange, green, pink and purple

Please specify colour when ordering



FOB1

Silicone Fob Watches

£6.95

Classic Fob Watch

Traditional fob watch design

- Robust, analogue clock dial

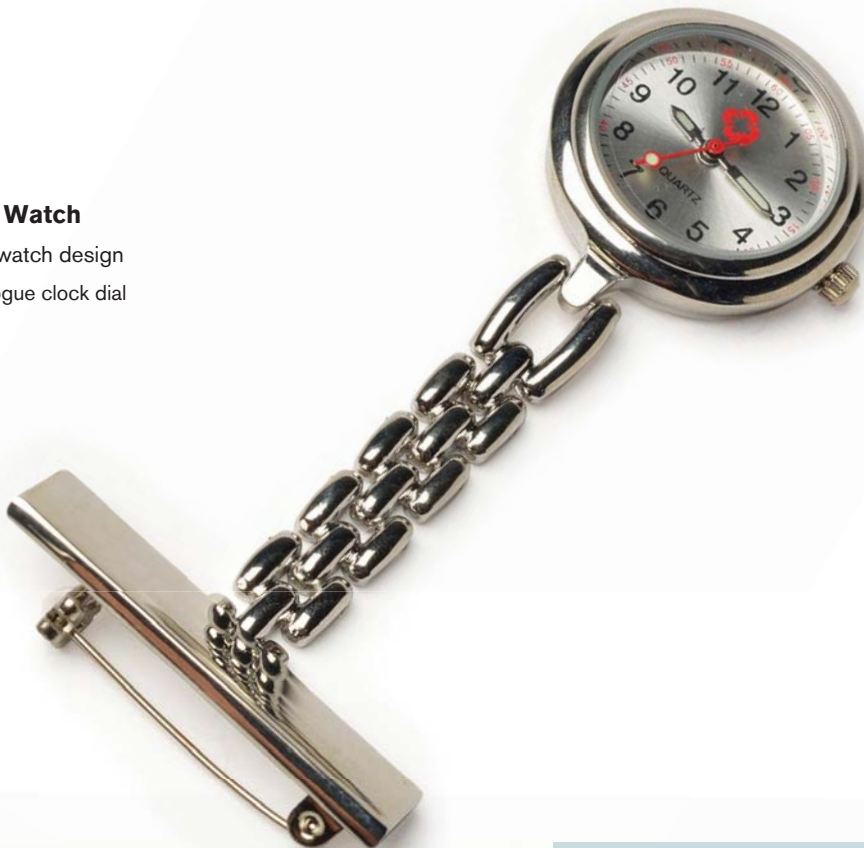

FOB2

Classic Fob Watch

£6.95

Your local medical supplier is just a phone call away. See cover for full details

Prices shown are exclusive of VAT and delivery

Cases & Bags

Bollmann Visita Case

- Generously designed medical case, that opens flat for easy access to contents
- Fully adjustable internal compartments, in easy to clean plastic
- Transparent covers with magnetic closures
- Two foam ampoule trays hold 74 ampoules
- Large front pocket
- Strong security locks, and double carrying handle
- Available in scratch proof leather or leatherette
- 42cm L x 29cm H x 18cm W
- Weight without contents 3.3kg, leather
- Weight without contents 3.2kg, leatherette



1.12.111	Bollmann Visita Case, black leather	£424.30
1.12.112	Bollmann Visita Case, brown leather	£424.30
1.12.113	Bollmann Visita Case, burgundy leather	£424.30
1.12.311	Bollmann Visita Case, black leatherette	£332.00
1.12.312	Bollmann Visita Case, brown leatherette	£332.00
1.12.313	Bollmann Visita Case, burgundy leatherette	£332.00

Bollmann Medica 2000 Case

- Front opening division for diagnostic equipment and papers
- Main section with plastic adjustable interior, to suit personal requirements
- Transparent cover with magnetic closures
- Large "hidden" 84 ampoule tray within main compartment
- Front compartment can hold lap top computer
- Four external locks for added security
- Double carrying handles for comfort and strength
- 42cm L x 29cm H x 19cm W
- Weight without contents 3.9kg
- Also available with additional front document holder, on request
- Weight without contents 4.2kg



1.21.111	Bollmann Medica 2000 Case, black leather	£472.00
1.21.113	Bollmann Medica 2000 Case, burgundy leather	£472.00
1.21.311	Bollmann Medica 2000 Case, black leatherette	£401.00
1.21.121	Bollmann Medica 2000 Case, black leather*	£517.70
1.21.123	Bollmann Medica 2000 Case, burgundy leather*	£517.70
1.21.321	Bollmann Medica 2000 Case, black leatherette*	£454.80

* with additional front pocket

Bollmann Piccola Case

- Compact medical case, that opens flat for easy access to contents
- 3 plastic compartments on either side of case
- Transparent covers with magnetic closures
- Ampoule tray
- Front document holder
- With twin handles
- Available in 2 sizes

Large

- 41cm L x 28cm H x 13cm W
- Weight without contents 2.8kg leather
- Weight without contents 2.7kg leatherette



Small

- 36cm L x 25cm H x 13cm W
- Weight without contents 2.3kg leather
- Weight without contents 2.2kg leatherette



1.09.131	Bollmann Piccola Case, black leather	£368.50
1.09.133	Bollmann Piccola Case, burgundy leather	£368.50
1.09.331	Bollmann Piccola Case, black leatherette	£280.20
1.09.333	Bollmann Piccola Case, burgundy leatherette	£280.20

1.09.121	Bollmann Piccola Case, black leather	£329.90
1.09.123	Bollmann Piccola Case, burgundy leather	£329.90
1.09.321	Bollmann Piccola Case, black leatherette	£262.90
1.09.323	Bollmann Piccola Case, burgundy leatherette	£262.90

Your local medical supplier is just a phone call away. See cover for full details

Prices shown are exclusive of VAT and delivery

Bollmann Practicus Case

- Fashionable and smart, yet traditional design
- Aluminium frame and central security lock
- Washable interior with adjustable compartments
- Available in scratch proof leather or easy-care polymousse
- 45cm L x 22cm H x 20cm W
- Weight without content 1.9kg, leather
- Weight without content 1.4kg, polymousse



1.13.121	Bollmann Practicus Case, black leather	£273.10
1.13.122	Bollmann Practicus Case, brown leather	£273.10
1.13.123	Bollmann Practicus Case, burgundy leather	£273.10
1.13.411	Bollmann Practicus Case, black polymousse	£168.30
1.13.415	Bollmann Practicus Case, blue polymousse	£168.30

Bollmann Medistar Case

- Traditional design doctors case with aluminium frame
- Spring mechanism holds bag wide open for easy access to contents
- Easy-clean plastic compartment with adjustable dividers
- Washable lining and inner pockets
- Twin handle for comfort and strength
- Integral lock with finger touch opening
- 44cm L x 25cm H x 25cm W
- Available with 1 or 2 external pockets
- Pocket size 32cm W x 23cm D



1 External Pocket

- Weight without contents 2.1kg leather
- Weight without contents 1.8kg polymousse/leather

1.20.111	Bollmann Medistar Case, black leather	£380.70
1.20.112	Bollmann Medistar Case, brown leather	£380.70
1.20.113	Bollmann Medistar Case, burgundy leather	£380.70
1.20.411	Medistar in easy-care black polymousse/black leather	£239.60

2 External Pockets

- Weight without contents 2.2kg leather
- Weight without contents 1.9kg polymousse/leather

1.20.121	Bollmann Medistar Case, black leather	£424.30
1.20.122	Bollmann Medistar Case, brown leather	£424.30
1.20.123	Bollmann Medistar Case, burgundy leather	£424.30
1.20.421	Medistar in easy-care black polymousse/black leather	£269.00

Bollmann Assista Case

- Traditional and elegant design, scratch proof leather case
- Lightweight and practical
- Internal plastic compartment with adjustable dividers
- Strong frame with 2 side catches and central lock
- Washable lining and 2 inner pockets
- Standard size: 40cm L x 23cm W x 17cm H
- Large size: 40cm L x 23cm W x 30cm H
- Weight without contents 2kg

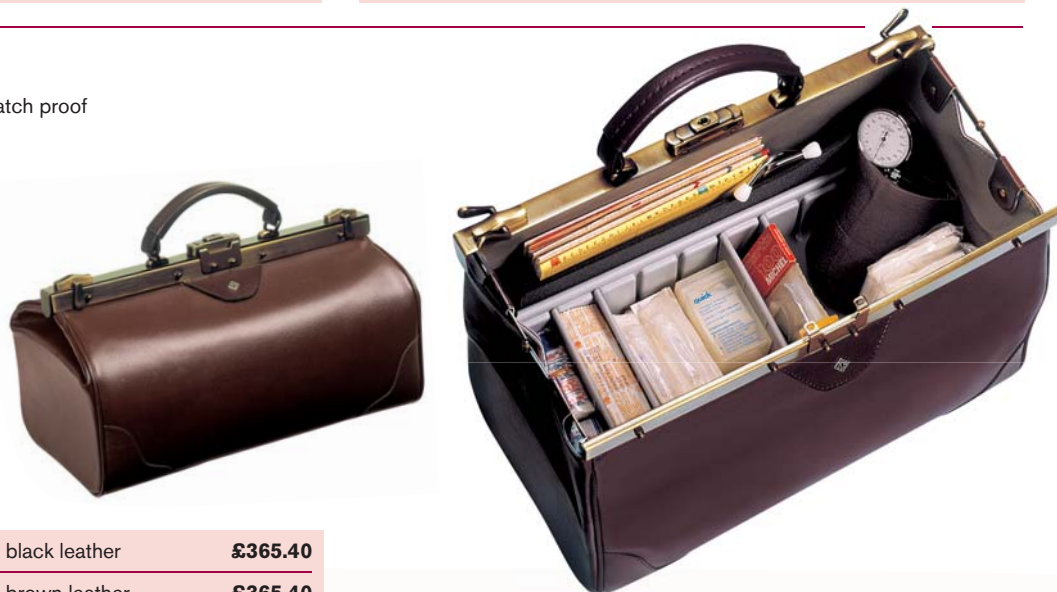

1.14.111	Bollmann Assista Case, black leather	£365.40
1.14.112	Bollmann Assista Case, brown leather	£365.40
1.14.113	Bollmann Assista Case, burgundy leather	£365.40

1.14.121	Bollmann Assista Large Case, black leather	£380.00
-----------------	--	----------------

Your local medical supplier is just a phone call away. See cover for full details

Prices shown are exclusive of VAT and delivery

Cases & Bags

Bollmann Progress Case with optional interior light!



- Tough ABS and aluminium construction
- Scratch proof leather finish
- Cantilever design interior, gives more effective use of space
- Plastic interior with adjustable dividers
- Easy to clean
- Large "hidden" 84 ampoule tray, built into lid
- Large exterior leather document holder
- Double handle, shaped for comfort and strength
- Two side mounted locks for added security
- 46cm L x 33cm H x 20cm W
- Weight without contents 4kg

Bollmann Progress case with illumination

- As Bollmann Progress case with built in 4v halogen illumination
- Requires AA size batteries

1.23.621	Bollmann Progress with illum., grey/black	£445.60
1.23.622	Bollmann Progress with illum., grey/brown	£445.60
1.23.623	Bollmann Progress with illum., grey/burgundy	£445.60

1.23.611	Bollmann Progress Case, grey/black	£401.00
1.23.612	Bollmann Progress Case, grey/brown	£401.00
1.23.613	Bollmann Progress Case, grey/burgundy	£401.00

Bollmann Nova Case

- Rigid aluminium frame and hinges
- Opens flat for easy access to contents
- Durable plastic interior with individually adjustable compartments
- Transparent covers with magnetic closures
- Strong external locks and double carrying handle
- Three stacking foam ampoule trays, holds 60 ampoules
- Large front document pocket
- 46cm L x 18cm W x 33cm H
- Weight without contents 3.8kg



1.18.111	Bollmann Nova Case, black leather	£394.90
1.18.112	Bollmann Nova Case, brown leather	£394.90
1.18.113	Bollmann Nova Case, burgundy leather	£394.90
1.18.311	Bollmann Nova Case, black leatherette	£305.60
1.18.312	Bollmann Nova Case, brown leatherette	£305.60
1.18.313	Bollmann Nova Case, burgundy leatherette	£305.60

Your local medical supplier is just a phone call away. See cover for full details
Prices shown are exclusive of VAT and delivery

Bollmann Classic Doctors Bag

- Traditional and elegant design
- Lightweight and practical
- Metal frame and central security lock
- Leather handle
- Inner compartment with adjustable dividers
- Inner pocket with zip
- Washable interior
- Outer zip pocket with divisions for pens and small utensils
- All around edge protector
- Fine real leather
- 240 H x 210 W x 420 L mm
- Weight: 2.0 kg



1.15.111	Bollmann Classic Doctors Bag, Black	£197.50
1.15.112	Bollmann Classic Doctors Bag, Brown	£197.50
1.15.113	Bollmann Classic Doctors Bag, Burgundy	£197.50

Bollmann Concertina Case

- Cantilever design for more efficient use of space
- Four adjustable side compartments
- Interior of hard-wearing plastic, easy to clean
- Fully adjustable to suit individual requirements
- Internal document holder
- Two internal ampoule trays, holds 46 ampoules
- Aluminium frame and integral lock
- Double handle for strength and comfort
- Available in scratch-proof leather or leatherette
- 43cm L x 21cm W x 27cm H
- Weight without contents 3.9kg
- Height of base compartment 12cm



Bollmann Concertina Deep Base

- 43cm L x 21cm W x 32cm H
- Weight without contents 4.2kg
- Height of base compartment 17cm



1.06.121	Bollmann Concertina Deep Base black leather	£492.30
1.06.122	Bollmann Concertina Deep Base brown leather	£492.30
1.06.123	Bollmann Concertina Deep Base burgundy leather	£492.30
1.06.321	Bollmann Concertina Deep Base black leatherette	£401.00
1.06.322	Bollmann Concertina Deep Base brown leatherette	£401.00
1.06.323	Bollmann Concertina Deep Base burgundy leatherette	£401.00
1.06.326	Bollmann Concertina Deep Base As above grey leatherette	£401.00

Concertina

8.09.106	Shoulder strap for Concertina (must be ordered with case, cannot be retro fitted)	£37.80
1.06.111	Bollmann Concertina Case, black leather	£472.00
1.06.113	Bollmann Concertina Case, burgundy leather	£472.00
1.06.311	Bollmann Concertina Case, black leatherette	£390.80
1.06.313	Bollmann Concertina Case, burgundy leatherette	£390.80

Your local medical supplier is just a phone call away. See cover for full details

Prices shown are exclusive of VAT and delivery

Cases & Bags

Bollmann Promed Bag

- Original and versatile design medical case
- Innovative layout is ideal for both general and emergency care
- Water and dirt repellent
- Easy to clean ABS plastic tray on one side with adjustable dividers
- 4 removable clear cases with the ability to hold an oxygen cylinder
- Central divider lifts automatically when case is opened and includes a foam tray for 74 ampoules
- Removable cushioned shoulder straps mean the Promed can be worn as a back pack
- Manufactured from top quality polymousse in a choice of black, blue or red
- Dimensions 33cm L x 25cm W x 46cm H
- Weight without contents 3.5kg

1.02.410	Bollmann Promed Bag, silver	£279.20
1.02.411	Bollmann Promed Bag, black	£279.20
1.02.415	Bollmann Promed Bag, blue	£279.20
1.02.417	Bollmann Promed Bag, red	£279.20



Bollmann Care Case

- Manufactured in lightweight and tough polymousse
- Front opens fully for easy access
- Interior includes removable and adjustable plastic compartment, and elasticated loops for instruments etc.
- Reverse flap with key holders and clear folder for patient notes
- 2 spacious side pockets
- Shoulder strap for easy carrying
- 43cm L x 31cm x 26cm W
- Weight without contents 1.3kg

1.04.411	Bollmann Care Case, black polymousse	£158.10
1.04.415	Bollmann Care Case, blue polymousse	£158.10
1.04.417	Bollmann Care Case, red polymousse	£158.10



Bollmann Medicare Case

- Lightweight (only 1500g)
- Adjustable shoulder strap + twin handle
- Base unit with adjustable compartments. Transparent cover with magnetic closures
- Lid with inside pocket for Ampoule Holders, Document Folders and other flat items
- Manufactured from tough polymousse material
- 46cm L x 33cm W x 12cm H



1.01.411	Bollmann Medicare Case, black	£158.10
1.01.415	Bollmann Medicare Case, blue	£158.10
1.01.417	Bollmann Medicare Case, red	£158.10

Your local medical supplier is just a phone call away. See cover for full details

Prices shown are exclusive of VAT and delivery

Bollmann Medicus Case

- The inner rack of the case features 2 plates and 3 removable variable compartments
- The central plate can be removed to allow space for taller items in the base compartment
- Roomy outer pocket. An additional pocket of netting material for documents located in the outer flap
- One ampoule holder with clear view cover for 37 ampoules
- Adjustable shoulder strap that can also be removed
- Weight 3kg
- Manufactured from high class polymousse material
- Dimensions: 42cm L x 21cm W x 32cm H

1.03.411	Bollmann Medicus Case, black	£301.50
1.03.415	Bollmann Medicus Case, blue	£301.50
1.03.417	Bollmann Medicus Case, red	£301.50



Bollmann Easycare Case

- Extremely light. Only weighs 1300g
- Very roomy - attractive design
- Deep adjustable plastic compartment
- Lid with elastic loops for scissors, pens etc, and additional inner pocket for papers
- Innovative zip closure with digital lock
- Bottom water and dirt repellent
- 37cm L x 22cm W x 24cm H

1.00.411	Bollmann Easycare Case, black	£130.60
1.00.415	Bollmann Easycare Case, blue	£130.60
1.00.417	Bollmann Easycare Case, red	£130.60



Bollmann Alternative Case

- Manufactured in lightweight and tough polymousse
- Deep central compartment and cantilever action opening with four trays
- Full interior in strong, easy to clean plastic
- Variable division of compartments
- Two removable foam ampoule trays, for 46 ampoules
- Two large side pockets and internal clear document pocket
- Carrying handle on top
- Two padded shoulder straps, allows carrying as "back-pack"
- Dimensions 40cm L x 36cm H x 24cm W
- Weight without contents and without straps 2.7kg
- Weight without contents with straps 2.8kg

With Shoulder straps

1.05.421	Bollmann Alternative, black polymousse	£297.40
1.05.425	Bollmann Alternative, blue polymousse	£297.40
1.05.427	Bollmann Alternative, red polymousse	£297.40

Alternative Without Shoulder straps

1.05.411	Bollmann Alternative, black polymousse	£273.10
1.05.415	Bollmann Alternative, blue polymousse	£273.10
1.05.417	Bollmann Alternative, red polymousse	£273.10



Your local medical supplier is just a phone call away. See cover for full details

Prices shown are exclusive of VAT and delivery

Cases & Bags

Med 1 - GP Case

- Triple frame ABS construction
- Strong key-fastening lock, with toggle clasps
- Base tray has deep moulded compartments with foam inserts
- Customisable for users own requirements
- Foam insert in lid with plastic phials
- 3 part document holder
- Dimensions: 46.5 x 33.5 x 12.75 cm
- Weight without contents 3.2kg
- Silver version available



1.60.100 Med 1 GP Case

£155.00

Med 8 - GP Deluxe Case

- Triple frame ABS construction
- Strong key-fastening lock, with toggle clasps
- Base tray has deep moulded compartments with moveable dividers
- 3 part document holder, can be used as convenient writing area
- Foam insert in lid with plastic phials, customisable
- Template and scalpel included
- Dimensions: 46 x 34 x 16.5 cm Weight: 4kg
- Silver version available



1.60.110
Med 8 GP Deluxe Case

£180.00

Med 16 - GP Supreme Case

- Strong and reliable triple frame ABS case
- Key operated toggle locks
- Base tray has moulded compartments with moveable dividers
- Clear cover secures contents of base tray
- 3 part document holder
- Lid contains plastic phials and 5 plastic storage boxes, securely in foam
- Dimensions: 46 x 34 x 16.5 cm
- Weight: 4kg
- Silver version available



1.60.120 Med 16 GP Supreme Case

£190.00

Your local medical supplier is just a phone call away. See cover for full details
Prices shown are exclusive of VAT and delivery

Bollmann Compact Ampoule Holder

- Compact design, holds 42 ampoules securely
- Hard wearing leatherette outer with twin foam lined trays
- 21cm x 13cm x 5cm
- Weight without contents 260g



3.09.311 **£34.99**
Bollmann Compact Ampoule Holder, black

3.09.313 **£34.99**
Bollmann Compact Ampoule Holder, burgundy

3.09.312 **£34.99**
As above in brown

AW Leather Instrument Case

- Black leather, fold out design
- Removable washable instrument compartments
- Holds up to 20 instruments
- Zip fastening

Note: Instruments not included



4.08.111 AW Leather Instrument Case **£24.50**

Bollmann Leather Instrument Case

- High quality surgical instrument holder
- Scratch proof real leather casing with zip closure
- Detachable canvas interiors with instrument pockets, washable

Note: Instruments not included



2.06.111 **£44.90**
Bollmann Leather Instrument Case, weighs 130g 18cm x 10cm
Holds 12 instruments up to 16cm

2.06.121 **£59.20**
Bollmann Leather Instrument Case, weighs 320g 21cm x 15cm
Holds 20 instruments up to 18cm

Bollmann Leather Ampoule Holder

- Scratch proof real leather case, with easy to clean plastic inner lining. Zip fastening
- 60 ampoules can be held securely by elastic loops
- 22cm x 16cm
- Weight without contents 300g
- Also available in Polymousse (weight without contents 210g)

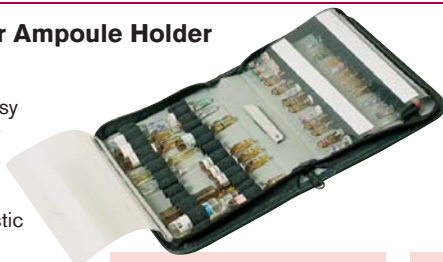

3.07.111 **£86.00**
Bollmann Leather Ampoule Holder, black

3.07.112 **£86.00**
As above in brown

3.07.113 **£86.00**
As above in burgundy



3.07.411 **£64.99**
Bollmann Polymousse Ampoule Holder, black

3.07.415 **£64.99**
As above in blue

3.07.417 **£64.99**
As above in red

Bollmann Document Folder

- 9 separate compartments allow ample space for prescriptions, record cards and forms
- 3 section fold-out design
- Includes writing pad and pen
- Choice of black or blue top high-quality polyester. Silver version available
- Dimensions
Small: 20cm x 25.5cm 520g
Large: 25.5cm x 34cm 950g



6.02.411 **£79.50**
Bollmann Document Folder, black - Small

6.02.415 **£79.50**
As above in blue

6.02.421 **£99.00**
Bollmann Document Folder, black - Large

6.02.425 **£99.00**
As above in blue

AW Canvas Instrument Roll

- Soft canvas instrument roll, beige and yellow
- Holds instruments safely
- Tie fastening

Note: Instruments not included



S.350.00 AW Canvas Instrument Roll **£8.20**

AW Leather Ampoule Holder



- Black leather, zip fastening ampoule case
- Clear protective covers
- Holds 60 ampoules securely
- Dimensions 22cm x 15cm x 4.5 cm
- Weight 230g

4.05.111 AW Leather Ampoule Holder **£24.50**

Bollmann Clear-View Ampoule Holder

- Foam lined ampoule tray, holds up to 37 ampoules
- Transparent cover for easy selection
- 26cm x 15cm. Weight without contents 130g



3.01.320 **£20.35**
Bollmann Clear-View Ampoule Holder

Your local medical supplier is just a phone call away. See cover for full details

Prices shown are exclusive of VAT and delivery

Dermatology Introduction to OPTICLAR D-Scope

Introducing a new standard in LED Dermoscopy - OPTICLAR D-Scope

The NEW OPTICLAR VISIONMED D-Scope Dermatoscope takes dermatology to a new level. Packed with features and benefits that have been requested by top specialists in the Dermatology field. Fantastic performance combined with superbly competitive pricing makes the OPTICLAR dermatoscope the all round best proposition when considering new equipment.

- Powered by 4 high performance LEDs for superb illumination
- Provides an excellent screening tool for early detection of malignant melanomas
- First class optics ensure excellent edge to edge magnification free from spherical and chromatic aberration
- Record and document findings with the excellent operating microscope derived optics ensuring first class images using either a simple compact camera adaptor, SLR adaptor or Smart phone camera adaptor

Switchable Polarisation/Immersion Dermoscopy

- Initial examination is easily accomplished using the Polarisation setting on the rotating contact plate, if more detailed examination is required simply rotate contact plate to immersion setting and apply the chosen contact medium, **no need to change contact plates**

Small Lesion Contact Plate

- If the lesion is difficult to access simply remove contact plate and fit the extended small lesion plate, access can now be made between fingers and toes and other hard to reach areas

Unique to D-Scope - Worlds first single use contact plate system

- Simple and effective solution to minimise cross infection - if accessing personal areas such as the genitals and anal region fit the disposable contact plate holder and clip on the disposable contact plate. When finished simply flick the disposable contact plate into a suitable clinical waste receptacle
- Disposable contact plate system can be used with either polarised light or for contact dermatoscopy

X/Y Measuring Graticule

- In addition to standard clear and straight measuring graticule plates, D-Scope can be used with the unique X/Y Graticule Plate
- X/Y graticule provides unique referencing points for training and peer to peer discussion
- Compatibility as standard with American brand Twist lock handles or upon request with German brand Auto-lock connector



Switch turns off 2 LEDs enhancing perception of depth and structure of lesion

Finger tip focus control

Finger tip change from Immersion to polarization filter



Your local medical supplier is just a phone call away. See cover for full details

Prices shown are exclusive of VAT and delivery

OPTICLAR D-Scope Dermoscopes Sets Dermatology

Opticlar D-Scope Dermoscope Sets

All Opticlar D-Scope Sets include:

- D-Scope with immersion/polarisation option
- Contact plate with X/Y graticule
- Single use contact plate system
- Zip storage case
- Choice of power supply

For full details of Opticlar power supplies and handles see pages 36 -38



100.020.200 **£599.00**
 Opticlar D-Scope with combi immersion and polarisation plate with X/Y graticule plate and C cell handle

100.020.202 **£749.00**
 Opticlar D-Scope set with combi immersion and polarisation plate with X/Y measuring graticule, Adapt Lithium Ion rechargeable handle and Single pod Desk Charger



100.020.201 **£659.00**
 Opticlar D-Scope set with combi immersion and polarisation plate with X/Y measuring graticule with USB lithium Ion rechargeable handle

100.025.200 **£699.00**
 Opticlar D-Scope with combi immersion and polarisation plate with X/Y measuring graticule. E rechargeable handle and Single pod charger

100.000.123/71 **£9.99**
 USB recharger to fit 3 pin UK plug

100.000.123/72 **£12.99**
 USB recharger to fit car accessory socket

Your local medical supplier is just a phone call away. See cover for full details
 Prices shown are exclusive of VAT and delivery

Dermatology OPTICLAR D-Scope Accessories



100.000.200/1

100.000.200/2



100.000.200/3



100.000.200/4

100.000.200/5

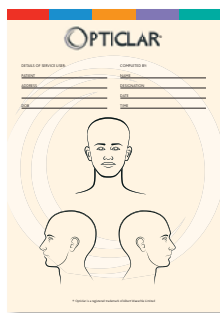
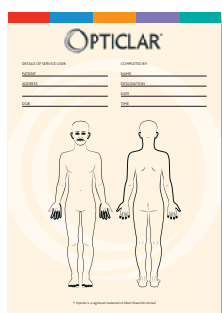

100.000.200/12



100.000.200/1	£75.00
Simple measuring graticule plate with Immersion and Polarisation Modes	
100.000.200/2	£75.00
X/Y graticule plate with Immersion and Polarisation Modes	
100.000.200/3	£75.00
Inaccessible lesion plate. 8mm diameter. Immersion mode only	
100.000.200/4	£29.00
Single patient plate holder with Immersion and Polarisation modes - not to be discarded	
100.000.200/5	£9.00
Pack of 10 Single patient use contact plates	
	£43.00
Pack of 50 Single patient use contact plates	
	£79.00
Pack of 100 Single patient use contact plates	
	£350.00
100.000.200/6	£49.50
Head to handle extension lead for use with camera system or when difficult to use fixed handle in restricted access sites	
Skin marking pens for temporary marking of suspect sites when performing body mapping. Helps prevent missed sites when documenting	
1437-10	£11.00
Mini Surgical Skin Marking Pens - Pack of 10	
1437-50	£46.00
Mini Surgical Skin Marking Pens - Pack of 50	
1437-100	£86.00
Mini Surgical Skin Marking Pens - Pack of 100	
100.000.200/12	£3.20
Body Maps, generic, front and rear, head front and side views. Helps document possible lesions when body mapping. Supplied in tear off pads of 100 sheets.	

Head and Handle Adaptors

For Dermatology departments that wish to upgrade to an OPTICLAR D-Scope we offer simple converters that allow use on German brand handles and charging systems, or to upgrade to OPTICLAR lithium ion rechargers and handles we offer a simple convertor that allows the use of German brand instruments on OPTICLAR handle systems.



100.000.999



100.000.998

100.000.998	£13.99
OPTICLAR handle to German brand head adaptor - simply locks on to provide secure fit for German brand instruments to Opticlar or WA handles	
100.000.999	£23.99
OPTICLAR head to German brand bayonet fitting handles - simply locks on to provide secure fit for Opticlar or WA instrument heads to German brand handles	



Camera Adaptors

- Range of camera adaptors to fix to the OPTICLAR dermatoscope for recording images and records

100.000.200/10	Compact camera	£155.00
100.000.200/15	Canon SLR	£209.00
100.000.200/20	Nikon	£209.00
100.000.200/30	Olympus	£209.00

Your local medical supplier is just a phone call away. See cover for full details

Prices shown are exclusive of VAT and delivery

HEINE DELTA 20® Plus Dermatoscope

For dermatoscopic examination of pigmented skin lesions and early diagnosis of malignant melanoma. Dermatoscopy oil is applied to the skin to make the outer skin layers more transparent. The DELTA 20® Plus makes

structure changes visible. The differential diagnosis of initial malignant melanoma and other pathologies is made easier and more accurate.



- Polarisation filter ensures a convenient diagnosis without liquids, detailed view of the crystalline and vascular structures within the lesion without immersion liquids and more comfortable examination experience for the patient
- High resolution, colour neutral optics with achromatic lens system produce undistorted image without colour fringes
- 10x to 16x magnification reveals the finest structural elements necessary for a reliable diagnosis
- Four high performance LEDs provide bright and absolutely homogenous illumination, accurate colour rendering and complete reproduction of the colour spectrum of a nevus
- Close to daylight LED homogenous illumination, with added lateral illumination by optional switch off of two LEDs to ensure a better visual perception of the structures of the skin surface



DERM SET

HEINE DELTA 20® PLUS Dermatoscope with immersion and polarisation filters - C Cell battery handle

£749.00

Your local medical supplier is just a phone call away. See cover for full details

Prices shown are exclusive of VAT and delivery

Dermatology Magnifiers & Skin Models

AW Hand held Magnifiers



- Full range of hand held magnifiers which can be used to assist in determining dermatological disorders
- Circular magnifiers give excellent image in 3 sizes, with bifocal lenses
- Magnifier with neck straps allow a wider field of view and is more convenient to use
- Illuminated magnifiers light the dermatological field, where an examination lamp is not available or for a further enhanced image
- Compact magnifiers give high magnification up to 15x
- All units are also useful when reading fine print and to improve overall vision
- 12 month warranty

43.3000	£15.10
Magnifying loupe 2x with 4x insert. 70mm dia x 166mm length	
43.3001	£15.10
Magnifying loupe 2x with 4x insert. 84mm dia x 191mm length	
43.3002	£16.40
Magnifying loupe 2x with 4x insert. 96mm dia x 214mm length	
43.3003	£16.40
Magnifying loupe 3x. 65mm dia x 170mm length	
43.3004	£18.40
Magnifying loupe 3x with illumination 65mm dia x 170mm length	
43.3005	£9.20
Magnifying loupe, folding, 3x. 60mm x 57mm x 15mm	
43.3006	£21.50
Magnifying loupe, 2x and 6x with illumination. 231mm x 82mm x 18mm	
43.3007	£18.40
Magnifying loupe, 3x with illumination. 117mm x 47mm x 15mm	
43.3008	£44.90
Magnifying loupe, 10x. 65mm dia x 38mm	

Skin Acne Model

- Enlarged cross section of skin
- Relief detail shows acne pistula (pimple)
- Reverse detail shows open comedo (blackhead)
- Also shown are Epidermis, Dermis & Subcutaneous tissue details of normal skin
- 10 x 10 x 11.5cm



J50 Skin Acne Model

£80.00

Skin Cancer Model

- This model shows three cancerous conditions;
 - Nodular Basal Cell
 - Malignant Melanoma
 - Morpheic Basal Cell
- And three non cancerous conditions;
 - Dyplastic Nevi
 - Keratoacanthoma
 - Basal layer and dermal layer cross sectional detail
- 11.5 x 11.5 x 3cm



J55 Skin Cancer Model

£77.00

Your local medical supplier is just a phone call away. See cover for full details

Prices shown are exclusive of VAT and delivery

The Mini Surgical Skin Marker

- Single patient use marker
- Mauve ink
- Sterile packed with separate ruler
- Economically priced
- Convenient pack sizes



1451-10	Mini Surgical Skin Marker - Pack of 10	£14.00
1451-50	Mini Surgical Skin Marker - Pack of 50	£45.00
1451-100	Mini Surgical Skin Marker - Pack of 100	£84.00

DERMarker Removable Ink Skin Marker - Non sterile

- Ideal for aesthetic non surgical procedures such as Body Mapping and Botox applications
- Suitable for procedures that do not require prep solution once mark has been made
- Ideal for Botox or areas of interest
- Available with red or green ink
- Convenient pack sizes



1445-10	Red DERMarker Pack of 10	£7.50
1444-10	Green DERMarker Pack of 10	£7.50
1445-30	Red DERMarker Pack of 30	£20.00
1444-30	Green DERMarker Pack of 30	£20.00
1445-240	Red DERMarker Pack of 240	£139.00
1444-240	Green DERMarker Pack of 240	£139.00

Blephmarker - Sterile

- Available with a choice of either ultrafine/ultrafine or ultrafine/regular tips
- Ideal for precise facial marking or other fine lines
- Twin ultra fine, soft rounded tips are perfect for the anatomy of a Blepharoplasty procedure
- Supplied sterile packed with separate ruler for ease of marking operating site



1425SR-10	Blephmarker Ultrafine/Regular tips. Pack of 10	£19.00
1424SR-10	Blephmarker Ultrafine/Ultrafine tips. Pack of 10	£19.00

AW Sterile Surgical Skin Marking Pens with Ruler

- Pre-operative skin marking pen ideal for minor surgery and dermatology applications
- 'Bullet' design allows fine or regular markings
- Non toxic mauve ink
- Latex free
- Supplied sterile individually packed in outer cases of 50 pieces
- Ruler ideal for measuring site
- Convenient pack sizes



1437-10	AW Surgical Skin Marking Pens - Pack of 10	£11.00
1437-50	Mini Surgical Skin Marker - Pack of 50	£46.00
1437-100	Mini Surgical Skin Marker - Pack of 100	£86.00

Compact Woods UV Light

- Hand-held ultraviolet lamp, ideal for detection of skin disorders
- Incorporates standard torch and 130mm UV tube
- Powered by 4 x AA batteries (included)
- 12 month warranty



95.06.000	Compact Woods UV Light	£55.10
95.06.000/1	Black UV bulb	£9.70
95.06.000/2	White UV bulb	£4.90

Your local medical supplier is just a phone call away. See cover for full details

Prices shown are exclusive of VAT and delivery

Dermatology Curettes

KAI Disposable Dermal Curette

Features:

- Stainless steel cutting edge for soft or weak tissue
- Ribbed handle for sure grip and precise control
- Orientation mark on handle
- Size embossed on each individual curette for easy and exact identification
- Wide range of sizes from 2.0mm diameter to 7.0mm diameter
- Sterile and ready to use with long shelf life
- Disposable
- UK Pattern - now with shorter neck for reduced flexibility

Used in the following minor skin surgical procedures:

- Curettage of a basal cell carcinoma
- Curettage of a verruca
- Curettage of other benign neoplasms of the skin

Clinical areas:

- Dermatology
- Gynaecology
- Podiatry
- Minor Surgery applications

Package:

- 20 individual sterile curettes in handy dispenser box



MK402 2.0mm



MK403 3.0mm



MK404 4.0mm



MK405 5.0mm



MK407 7.0mm

MK402 2.0mm diameter sterile single use curette, box of 20	£33.20
MK403 3.0mm diameter sterile single use curette, box of 20	£33.20
MK404 4.0mm diameter sterile single use curette, box of 20	£33.20
MK405 5.0mm diameter sterile single use curette, box of 20	£33.20
MK407 7.0mm diameter sterile single use curette, box of 20	£33.20

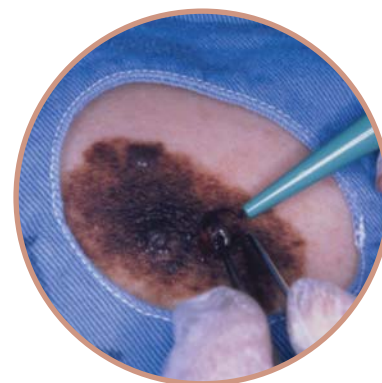

KAI BiopsiBlade

- Specifically designed to perform saucerisation of deep lesions and shave biopsy's
- Unique slit system allows easy and optimal arch formation
- Side handles provide a stable and secure grip
- Individually sterile packed in an outer box of 20 units
- Economically priced

BiopsiBlade
Pack of 20, individually packed. Sterile, single use

£21.30

Your local medical supplier is just a phone call away. See cover for full details

Prices shown are exclusive of VAT and delivery

KAI Disposable Biopsy Punch

We are pleased to offer a complete range of Biopsy Punches from one of the worlds leading manufacturers of sterile, single use punches and curettes.

Features:

- Seamless stainless steel sharp cutting edge
- Ribbed handle for sure grip and precise control
- Size embossed on each individual punch for easy and exact identification
- Wide range of sizes from 1.0mm diameter to 8.0mm diameter
- Smaller sizes 1.0mm to 4.0mm available in 0.5mm steps
- Sterile and ready to use with long shelf life
- Disposable

Clinical areas:

- Dermatology
- Gynaecology
- Podiatry
- Minor Surgery applications

Package:

- 20 individual sterile punches in handy dispenser box

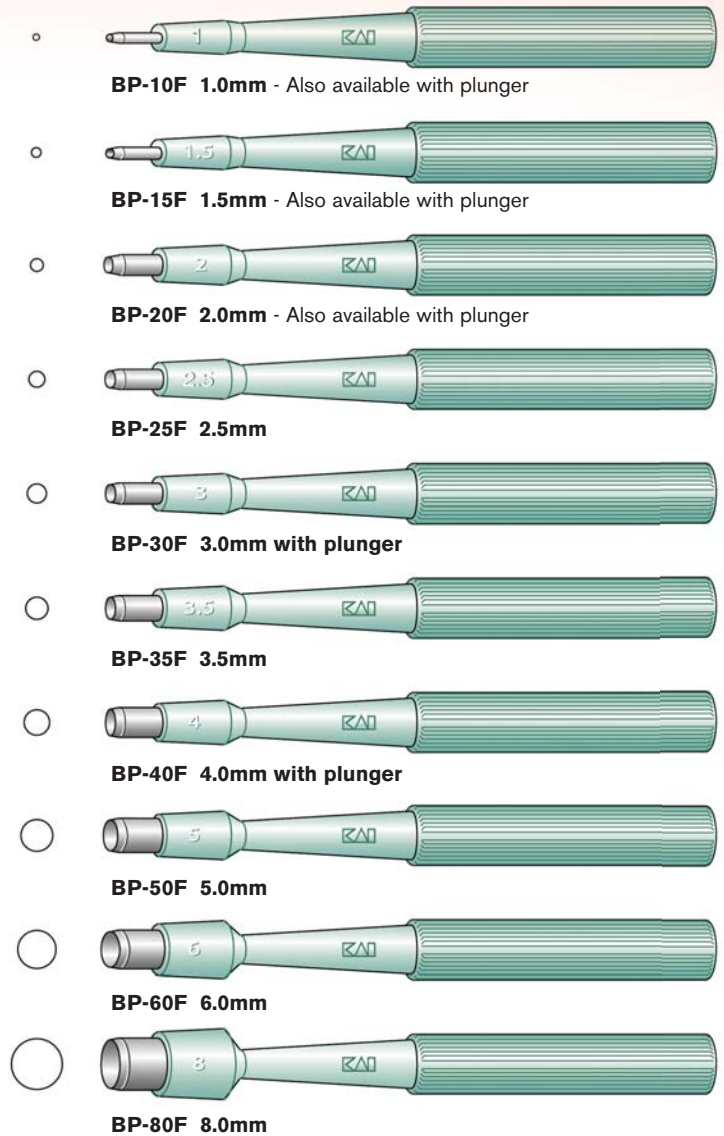

Also available with plunger:

- for easy ejection of small biopsy samples
- reduces damage to tissue sample
- available in 1, 1.5 and 2mm sizes

BP-10F	£33.20
1.0mm diameter sterile single use biopsy punch, box of 20	
BP-15F	£33.20
1.5mm diameter sterile single use biopsy punch, box of 20	
BP-20F	£33.20
2.0mm diameter sterile single use biopsy punch, box of 20	
BP-25F	£33.20
2.5mm diameter sterile single use biopsy punch, box of 20	
BP-30F	£33.20
3.0mm diameter sterile single use biopsy punch, box of 20	
BP-35F	£33.20
3.5mm diameter sterile single use biopsy punch, box of 20	
BP-40F	£33.20
4.0mm diameter sterile single use biopsy punch, box of 20	
BP-50F	£33.20
5.0mm diameter sterile single use biopsy punch, box of 20	
BP-60F	£33.20
6.0mm diameter sterile single use biopsy punch, box of 20	
BP-80F	£33.20
8.0mm diameter sterile single use biopsy punch, box of 20	

BPP-10F	£37.80
1.0mm diameter biopsy punch with plunger, box of 20	
BPP-15F	£37.80
1.5mm diameter biopsy punch with plunger, box of 20	
BPP-20F	£37.80
2.0mm diameter biopsy punch with plunger, box of 20	

Your local medical supplier is just a phone call away. See cover for full details

Prices shown are exclusive of VAT and delivery

Instruments & Minor Ops Vaginal Speculum

ProSpec Sims Disposable Vaginal Speculum

- Individually packed disposable single use Sims vaginal speculum
- Available in 3 popular sizes:
 - **small** 55mm x 27mm/65mm x 30mm
 - **medium** 65mm x 30mm/70mm x 32mm
 - **large** 75mm x 32mm/80mm x 36mm



F.370.01	£19.40
ProSpec Sims Vaginal speculum, small, pack of 20	
F.370.01/100	£91.80
As above, supplied single, packed in box of 100	
F.370.02	£19.40
ProSpec Sims Vaginal speculum, medium, pack of 20	
F.370.02/100	£91.80
As above, supplied single, packed in box of 100	
F.370.03	£19.40
ProSpec Sims Vaginal speculum, large, pack of 20	
F.370.03/100	£91.80
As above, supplied single, packed in box of 100	

ProSpec Sims Disposable Uterine Sounds



- Based on the shape of the popular metal Sims sound
- Curved with bulbous tip and graduated
- Supplied single packed
- Single use only
- Easily discarded in the Sharps bin or with other contaminated waste
- Graduated up to 24cm, total length 32cm

F.300.50	£12.80
ProSpec Sims Uterine sound, 32cm, single, packed in box of 10	
F.300.50/100	£112.20
As above, supplied single, packed in box of 100	

ProSpec Disposable Hegar Dilators



- Single use Hegar dilators in 5 popular sizes

F.350.02	£12.80
Sterile Hegar dilator, size 1-2, supplied single, packed box of 10	
F.350.02/100	£112.20
As above, single, packed box of 100	
F.350.04	£12.80
Sterile Hegar dilator, size 3-4, supplied single, packed box of 10	
F.350.04/100	£112.20
As above, single, packed box of 100	
F.350.06	£12.80
Sterile Hegar dilator, size 5-6, supplied single, packed box of 10	

F.350.06/100	£112.20
As above, single packed, box of 100	
F.350.08	£12.80
Sterile Hegar dilator, size 7-8, supplied single packed, box of 10	
F.350.08/100	£112.20
As above, single packed, box of 100	
F.350.10	£12.80
Sterile Hegar dilator, size 9-10, supplied singles packed, box of 10	
F.350.10/100	£112.20
As above, single packed, box of 100	

Smoke Tube Models



F.300.08	£24.50
ProSpec with smoke tube, medium extra long size, box of 10	

Your local medical supplier is just a phone call away. See cover for full details

Prices shown are exclusive of VAT and delivery

Vaginal Speculum Instruments & Minor Ops

Designed and manufactured to the highest quality standards, the ProSpec range of disposable vaginal speculums is produced by North Eos who apply the strictest quality standards to all aspects of the manufacturing process.

- Jaws position together securely to ensure no pinching occurs on withdrawal
- Manufactured from virgin materials promoting high resistance to brittleness.
- Smooth external surface ensures maximum patient comfort
- Efficient, fast action, screw thread ratchet system provides superior control
- No Lubrication required, helping to avoid costly re-screening from lubricated contaminated tests
- Independently tested and proven to be stronger than competitive alternatives, details available on request
- Recommended by Professional Development International as the 'CUSCO of Choice'
- Supplied sterile, individually packed, in boxes of 20

ProSpec



Superb quality moulding and detail provides smooth operation and ease of adjustment.



F.300.06 ProSpec Vaginal Speculum, box 20 mini	£19.00
F.300.00 ProSpec Vaginal Speculum, box 20 virgin	£19.00
F.300.01 ProSpec Vaginal Speculum, box 20 small	£19.00
F.300.02 ProSpec Vaginal Speculum, box 20 medium	£19.00
F.300.03 ProSpec Vaginal Speculum, box 20 large	£19.00
F.300.05 ProSpec Vaginal Speculum, box of 20, medium extra long	£19.00

Don't risk your patients comfort on inferior cheaper products. We monitor the quality of all our ProSpec products to ensure they provide optimum performance whilst remaining cost-effective.



The above image shows the gap between the jaws of a cheaper brand when fully closed. This can cause pinching on withdrawal.



The ProSpec Speculum above displays barely any discernible gap due to superior moulding and a fully tested design.



Prospec Winterton Vaginal Speculum

- For use on patients with a longer uterus
- Longer length jaws position together securely to avoid pinching on withdrawal
- Manufactured from virgin materials promoting high resistance to brittleness
- Smooth external surface ensures maximum patient comfort
- Efficient, fast action, screw thread ratchet system provides superior control
- No lubrication required, helping to avoid costly re screening from lubricated contaminated tests
- Supplied sterile, individually packed in boxes of 20
- Jaws: 115mm length x 23mm wide

F.300.07 ProSpec Winterton Vaginal Speculum box of 20 large slimline blades 150mm x 22mm x 88mm	£19.00
---	---------------

Your local medical supplier is just a phone call away. See cover for full details

Prices shown are exclusive of VAT and delivery

Instruments & Minor Ops Vaginal Speculum



I.U.C.D. Instrument Set

- Complete range of high quality instrumentation suited to I.U.C.D. applications, including:-
 - Sims Uterine Scissors 9" curved
 - Gallabins Uterine Sound 12.5"
 - Cusco Vaginal Speculum small
 - Cusco Vaginal Speculum medium
 - Cusco Vaginal Speculum large
 - Rampley Sponge Holding Forceps 9.5"
 - Luer Vulsellum Forceps 1:1 teeth, 9"
 - Spencer Wells Artery Forceps 8" straight
 - IUCD Removal Hook
- 3 year warranty

S.900.05 I.U.C.D. Instrument set, complete **£90.80**

Vaginal Speculum Set

- A wide selection of vaginal speculum, in one excellent value pack
- Set includes:-
 - 1 x Virgin Cusco Speculum
 - 1 x Small Cusco Speculum
 - 2 x Medium Cusco Speculum
 - 1 x Large Cusco Speculum
 - 1 x Medium X-Long Cusco Speculum
 - 1 x Medium Sims Speculum



S.915.00 Vaginal Speculum Set **£86.70**

Your local medical supplier is just a phone call away. See cover for full details
Prices shown are exclusive of VAT and delivery

Gynaecology

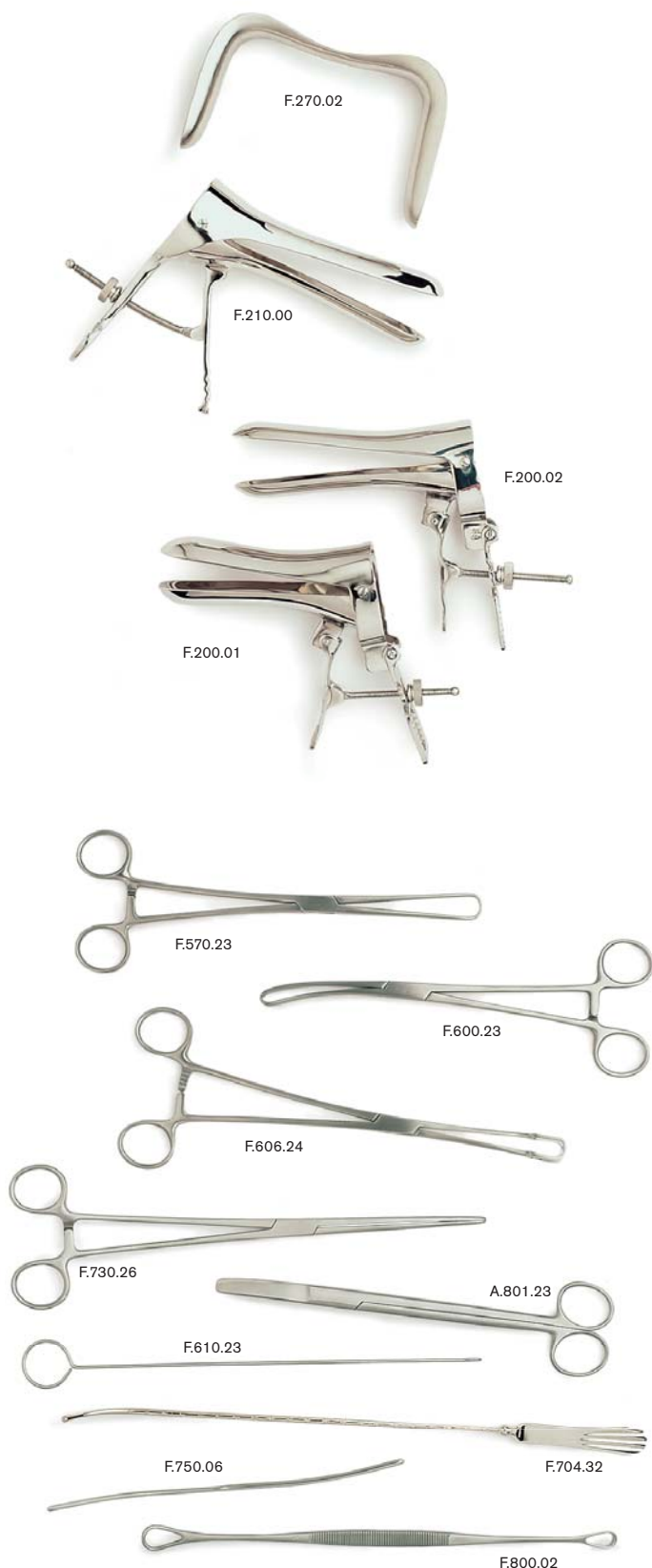

F.200.00	Cusco Vaginal Speculum, virgin	£8.90
F.200.01	Cusco Vaginal Speculum, small	£8.90
F.200.02	Cusco Vaginal Speculum, medium	£8.90
F.200.03	Cusco Vaginal Speculum, large	£8.90
F.200.04	Cusco Vaginal Speculum, extra large	£8.90
F.205.05	Cusco Vaginal Speculum, medium extra long	£8.90
F.210.00	Winterton Vaginal Speculum	£25.50
F.270.01	Sims Vaginal Speculum small	£8.70
F.270.02	Sims Vaginal Speculum medium	£8.70
F.270.03	Sims Vaginal Speculum large	£8.70
E.260.24	Rampléy sponge holding forceps 9.5"	£9.10
F.570.23	Luer Vulsellum Forceps 1:1 teeth 9"	£14.99
F.600.23	Teale Vulsellum Forceps 3:4 teeth 9"	£14.99
F.606.24	Schroeder Vulsellum Forceps 2:2 teeth 9.5"	£13.30
C.920.15	Allis Tissue Forceps 5"	£8.00
F.730.26	Bozemann Swab Forceps 10.25"	£10.80
A.801.23	Sims Uterine Scissors 9" curved	£9.30
F.610.23	IUCD removal hook	£5.90
F.704.32	Gallabins Uterine Sound 12.5"	£7.80
F.710.32	Sims Uterine Sound Malleable 12.5"	£7.80
F.750.04	Hegar Uterine Dilator 3/4mm	£7.80
F.750.06	Hegar Uterine Dilator 5/6mm	£7.80
F.750.08	Hegar Uterine Dilator 7/8mm	£7.80
F.750.10	Hegar Uterine Dilator 9/10mm	£7.80
F.800.02	Sims Uterine Curette D.ended sharp/blunt 6/9mm	£11.20

Disposable Metal Sims Speculum available in small, medium and large sizes

A range of sterile gynaecology instruments.

DF.610.22	IUCD remover, box of 50	£60.20
DF.710.32	Galabins flexible sound, box of 50	£101.00
DF.750.02	Hegar dilator, 1/2	£61.20
DF.750.04	Hegar dilator,	£61.20
DF.750.06	Hegar dilator, 5/6	£61.20

Your local medical supplier is just a phone call away. See cover for full details
Prices shown are exclusive of VAT and delivery

Instruments & Minor Ops Instruments

Falk Sieve Pessary

Manufactured from latex free, thermoplastic polymer pessary manufactured according to Dr. Falk. Designed to mechanically support the uterus after displacement of the uterus due to descent or prolapse and for therapeutical treatment due to incontinence, back pain, formation of residual urine etc.

This pessary is a simple, useful and effective alternative treatment if an operation is not possible due to the patient wishing to have children, if the patient refuses surgery or if the condition is inoperable.

Whilst initial fitting must be carried out by a doctor the patient can remove the pessary in the evening and refit again in the morning.

Please note that this product is a SINGLE PATIENT PRODUCT.

The pessary may be used for a maximum of 87 days however it should be inspected medically every 29 days.

- Available in a wide range of diameters from 50mm to 100mm in 5mm increments
- Autoclaveable at 121°C for a maximum of 15 minutes
- Single patient product
- Superb elasticity of the intermediate strip restores the round shell shape of the pessary after insertion
- Holes in pessary aid transfer flow of fluids



Latex Free

180.50.000

Available from 50mm to 100mm diameters in 5mm increments.

Dr. Falks Seive Pessary	(Please specify diameter)	
	50mm to 65mm	£39.50
	70mm to 85mm	£39.50
	90mm to 100mm	£39.50

ProBrush Cervical Sampling Brush

- Super-soft bristles improve patient comfort, reducing patient distress
- Long flexible stem and 'arrow' shaped head allow for faster, trouble-free sampling
- Sampling of endo and ecto cervix is simultaneous
- Sold clinically clean in packets of 25



F.300.10

ProBrush Cervical Sampling Brush, pack 25

£6.20

ProSpec

ProBrush Spatula and Brush

- Approximately 18cm long, double ended spatula and brush
- Hard plastic fronds with semi rigid scrapers mounted at right angles
- Ayres type spatula at the opposite end
- Supplied clinically clean in packs of 25



F.300.15

ProBrush Spatula and brush, figure 1

£6.20

- Approximately 18cm long, double ended spatula and brush
- Solid spiral thread with semi rigid scrapers mounted at right angles
- Ayres type spatula at the opposite end
- Supplied clinically clean in packs of 25



F.300.20

ProBrush Spatula and brush, figure 2

£6.20

Your local medical supplier is just a phone call away. See cover for full details

Prices shown are exclusive of VAT and delivery

Gynobrush Special

- Gynobrush Special, ideal for gynaecological sample with a specially designed head that tapers to a fine tip
- Approximately 20cm long and supplied clean but not sterile
- Not to be used for endometrial sampling

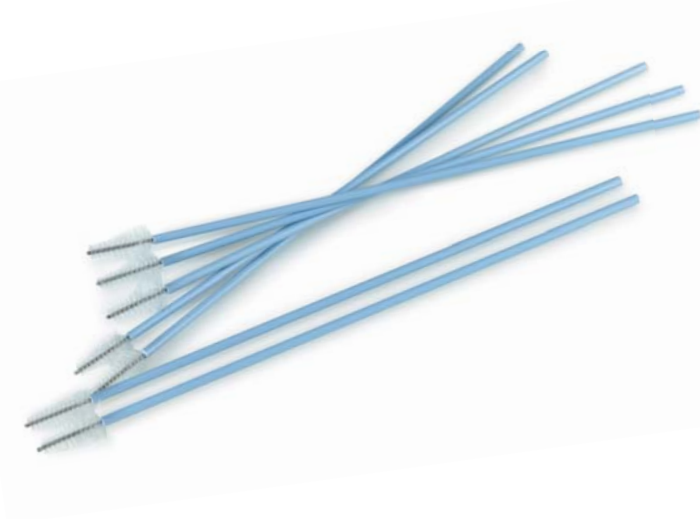

1032926 Box of 100 in packs of 10 x 10 **£39.00**

Ayres Spatulas



1090701 **£3.80**
 Ayres Spatula, type F, finger model in a box of 100

1090702 **£3.80**
 Ayres Spatula, type S, wooden in a box of 100

ProSpec Thread Retriever

- **Retrieve IUCD Threads** – quickly, easily and with improved patient comfort
- **Extended Handle** – measuring 204mm long, ensures the hand of the practitioner is kept further away from the patient
- **Ridged Handle** – easier to grip and improves control during procedure
- **12 Micro Teeth** – hook the thread effectively
- **Supplied Sterile** – individually packed
- **Dimensions** – overall length 298mm (handle 204mm to T/toothed section 94mm)



ProSpec

F.300.90 ProSpec thread retriever, single **£2.40**

Instruments & Minor Ops Proctology

BiHex Haemorrhoid Ligator Set

- Disposable single-use haemorrhoid ligator pack
- Ligator gun made from non-toxic plastic
- Moulded handle for easy application of bands
- Can be used with suction and grasping forceps
- Haemorrhoids easily visualised
- Eliminates need for cleaning/sterilisation, reducing risk of cross infection
- 7" working length
- Includes 4 bands in each pack
- Supplied sterile individually packed, in boxes of 15



BIHEX BiHex Haemorrhoid Ligator Set, box of 20 **£269.40**

Single Use Lighting Adaptors for use with Proctoscopes

- A comprehensive range of single patient use Welch Allyn and Heine lighting adaptors for use with the following:
 - Proctoscopes
 - Fogless
 - ProSpec
 - Eschmann
 - Seward Thackray

E-03.18.101 (Disp) **£1.30**
Heine Light source to Fogless/Eschmann/Seward Thackray Proctoscope with 6mm dia inlet

E-03.18.102 (Disp) **£1.30**
Heine Light source to Waeschle Prospec Proctoscope with 8mm diameter inlet

E-03.18.103 (Disp) **£1.30**
Welch Allyn light source to Fogless/Eschman/Seward Thackray Proctoscope with 6mm dia inlet

E-03.18.104 (Disp) **£1.30**
Welch Allyn light source to Waeschle Prospec Proctoscope with 8mm dia inlet

Proctology



I.170.00 St Marks Rectal Dilator small **£12.25**

I.170.01 St Marks Rectal Dilator medium **£12.25**

I.170.02 St Marks Rectal Dilator large **£12.25**

ProSpec Proctoscope ST

- A brand new version of the UK's most popular style of proctoscope
- Extremely high quality mouldings produce a very smooth and easy to insert instrument
- Shown with optional lighting attachment



I.360.02 **£18.20**
ProSpec proctoscope type ST, single use, box 20

McGivney Haemorrhoid Banding Instruments

- High quality, German made instruments, ideal for simple, fast banding of haemorrhoids
- The McGivney haemorrhoidal grasping forceps are angled and 19cm in length
- The McGivney ligator with loop handle has a 10mm cone for loading of the band
- Bands are available in thin and wide versions and are in packs of 100. Shelf life is 1 year when stored in a cool dark place



AWI-04-615 **£146.90**
McGivney Ligator with loop handle and 10mm cone

AWI-05-923 McGivney grasping forceps **£104.60**

AWI-04-648 Pack of thin ligator bands, pack 100 **£32.90**

AWI-04-649 Pack of wide ligator bands, pack 100 **£34.00**

Your local medical supplier is just a phone call away. See cover for full details

Prices shown are exclusive of VAT and delivery

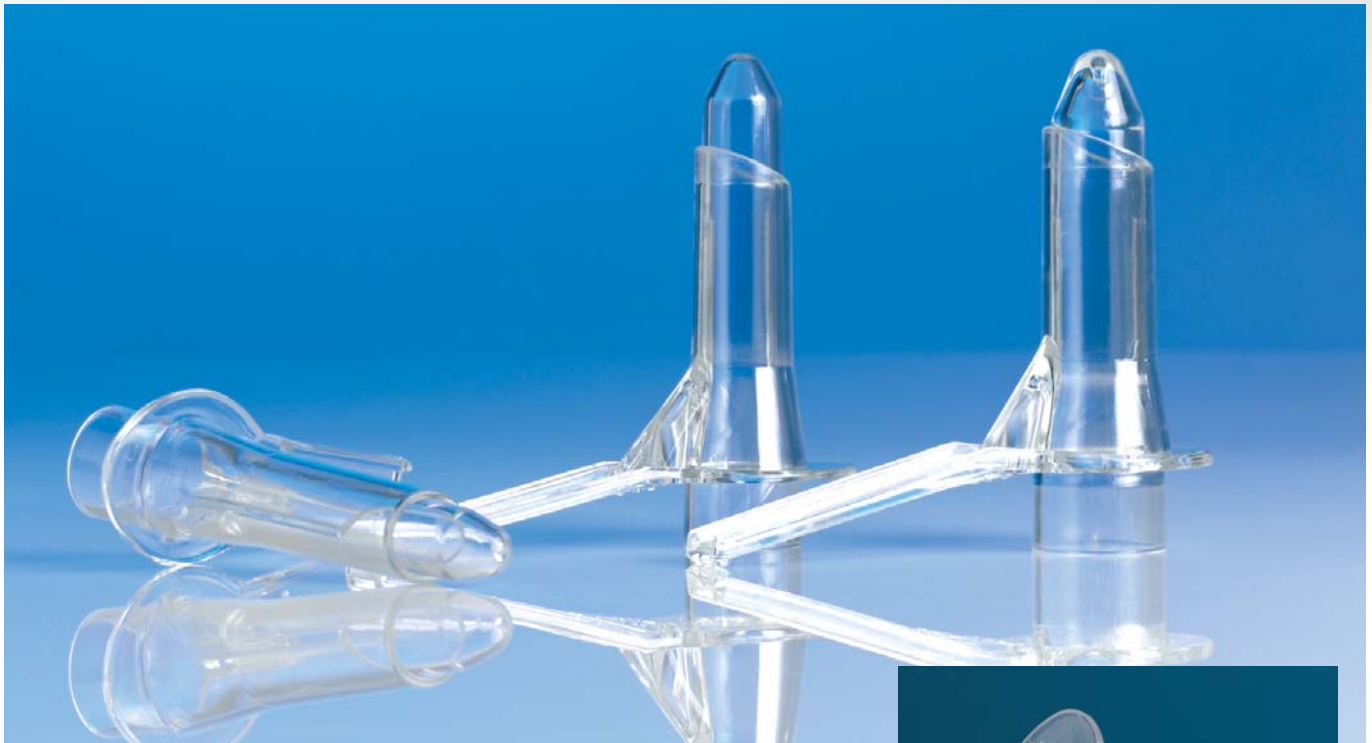

ProSpec Disposable Proctoscope

- High quality single use proctoscope
- Made from non toxic plastic with non-heavy metals, avoiding brittleness
- Strong and simple to use
- Supplied individually packed, in boxes of 20
- Light guide for F.O. illumination (available upon request)
- Suitable for use with BiHex Ligator set
- Small 50mm x 22.5mm
- Medium 85mm x 25/30mm
- Large 105mm x 28/32mm

ProSpec

I.350.01	ProSpec Disposable Proctoscope, box 20 small	£20.00
I.350.03	ProSpec Disposable Proctoscope, box 20 medium	£20.00
I.350.02	ProSpec Disposable Proctoscope, box 20 large	£20.00
E.003.18.102	Angled Fibre Optic Illuminator to fit Heine handle	£131.00

Sigmoidoscope Hygiene products

Disposable Single Use Sigmoidoscope Insufflation

- Disposable single use sigmoidoscope insufflation double bellows with net
- Latex free bellows
- Green
- Single Patient use



E-000.18.025	Sigmoidoscope filters for single use bellows, pack of 25	£60.00
E-000.18.105 DISP	Disposable single use sigmoidoscope insufflation bellows, pack of 10	£26.00

Anti-bacterial Insufflation Filter



- Anti-bacterial filter for use with insufflation bulb
- Fits between instrument head and insufflation bulb
- Eliminates risk of cross-infection from insufflation technique

E-000.18.100	Anti-bacterial Insufflation Filter, pack of 100	£207.10
E-000.18.105	Insufflation Double Bellow Bulb	£42.90

Your local medical supplier is just a phone call away. See cover for full details

Prices shown are exclusive of VAT and delivery

Instruments & Minor Ops Cautery

AW Elemental Cautery - Mains Unit



- High quality mains cautery unit 240v
- Smart and compact design
- Variable output control up to 20 ampere
- Non-slip feet, adjustable
- Robust cables and handles
- Choice of standard handle or pistol grip control
- Complete with 5 platinum-iridium tips. Non-oxidising, non-corroding, includes Coagulation ball, Ring cutter, Straight cutter, Loop and Cold-point.
- Versatile range of tips available in 5cm lengths as standard and 15 styles. (Non standard lengths available upon request - see below)

Disposable Single Patient Use Tips

- A selection of the most commonly used Elemental cautery tips are available for single patient use
- Each tip offers a cost effective alternative to traditional sterilisation methods
- Please note: with single patient use tips it is very important that each tip is gradually brought up to operating temperature
- Each tip is supplied clean, ready for use

09-156 PISTOL £938.00

Elemental Cautery - Mains Unit complete, with 5 tips and pistol grip handle

09-156 STANDARD £938.00

Elemental Cautery - Mains Unit complete, with 5 tips and standard handle

09-201-D10	Figure 201 single use tip	£11.99
09-203-D10	Figure 203 single use tip	£11.99
09-204-D10	Figure 204 single use tip	£11.99



A B C D E F G H
09-201 202 203 204 205 206 207 208

Accessories & Burners for the Elemental Mains Cautery Unit

09-20* £47.50

Standard 5cm length burners (*please use number of burner required)

Please Note: 3cm, 10cm, 15cm and 20cm length burners are available upon request

09-108 Standard Cautery Handle, with cable £175.00

09-104 Pistol Grip Cautery Handle with cable £175.00

09-10808 Retaining Screw for Cautery Handle £4.50



I K L M N O P
209 210 211 212 213 214 215



Your local medical supplier is just a phone call away. See cover for full details

Prices shown are exclusive of VAT and delivery

AW Elemental Cautery - Rechargeable Model for Minor Surgery

- Elemental Cautery system with rechargeable power supply
- Exceptionally compact 'foot-print' on desk charger, ideal for surfaces where space is at a premium
- Hygienic design - no awkward or difficult to clean areas
- Simple to use - just plug-in, recharge and use
- Intelligent charging system with NiMH rechargeable battery
- Fully charged from empty in 3 hours
- 10 -15 minutes continual operation from a full charge
- Twin lamp charging indicators
- Available with a choice of all purpose Minor Surgery tips (as shown - Ringcutter, Straight cutter, Co-ag ball, Cold point and Angled) or standard surgery tips (set of 3)
- Slim handle with exact-touch control, highly accurate and well balanced in use
- Fully autoclavable handle and tips (excluding battery)
- Compact case included for handle and tips, allowing portability if required
- 3 year warranty (excluding battery and tips)
- **Please select your tip configuration from the options below**



09-610GS	£599.00
Elemental rechargeable cautery system, complete with handle/2 rechargeable cells (tips not included)	
09-620GS	£87.00
Set of 3 standard minor surgery tips, Ring cutter, Straight cutter & Co-ag ball	
09-620CS	£138.00
Set of 5 all purpose tips, including Ring cutter, Straight cutter, Co-agulation ball, needle/cold point and angled tip	
19E-030.02	£22.05
Tip-Safe Sterilisation box - holds 3 Elemental cautery tips for autoclaving	

Disposable Single Patient Use Tips

- A selection of the most commonly used Elemental cautery tips are available for single patient use
- Each tip offers a cost effective alternative traditional sterilisation methods
- Please note: with single patient use tips it is very important that each tip is gradually brought up to operating temperature
- Each tip is supplied clean, ready for use

09-508-D10	Figure 508 single use tip	£11.99
09-504-D10	Figure 504 single use tip	£11.99
09-510-D10	Figure 510 single use tip	£11.99

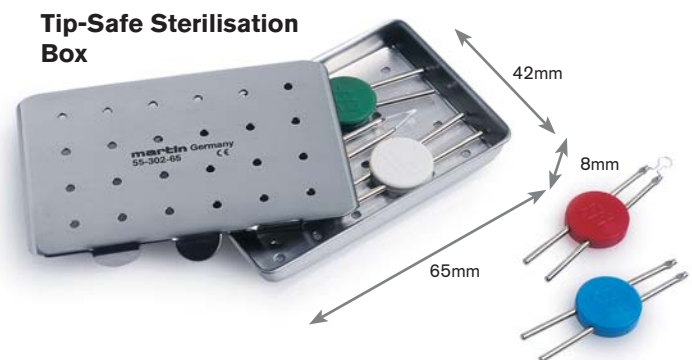

Accessories and burners for AW Elemental Rechargeable Cautery

09-504	Needle/Cold Point	£27.50
09-507	Straight cutter, Heavy Duty	£27.50
09-508	Straight cutter, Normal	£27.50
09-509	Ring cutter, Heavy Duty	£27.50
09-510	Co-agulation Ball	£27.50
09-405	Replacement Rechargeable Handle	£119.00
09-405-30	Replacement NiMH Battery	£49.00



Your local medical supplier is just a phone call away. See cover for full details
Prices shown are exclusive of VAT and delivery

Instruments & Minor Ops Cautery

AW Battery Operated Cautery Set

- Economical battery powered cautery unit
- Suitable for basic application minor surgery
- Simple push connection for tips
- Fingertip power control
- Supplied complete with 2 large and 2 small cautery burners
- Choice of large or slim handles
- Includes foam lined storage case



95.50.005 £68.00
AW Battery Operated Cautery Set, slim handle (2 x AA batteries)

Accessories for AW Battery Operated Cautery

95.50.030	Disposable Single Patient Use Short Fine Tip	£8.00
95.50.031	Disposable Single Patient Use Short Loop Tip	£8.00
95.50.032	Disposable Single Patient Use 25mm Flexible Tip	£8.00
95.50.036	Disposable Single Patient Use Short Circular Tip	£8.00
95.50.037	Disposable Single Patient Use 25mm Fine Tip	£8.00
95.50.040	Disposable Single Patient Use Short Heavy Duty Tip	£8.00



Disposable Single Patient Use Cauteries

This new range of Disposable Single Patient Use Cauteries overcomes the problem of cleansing and sterilisation of conventional tips.

- Simple and convenient to use
- Cauteries are supplied sterile
- Choice of tip configuration to cater for most demands
- Supplied individually or as a bulk pack of 10



09-AA01	High temp (1204°C) fine tip	£13.50
09-AA01/10	High temp (1204°C) fine tip, box of 10	£110.00
09-AA03	High temp (1204°C) loop tip	£13.50
09-AA03/10	High temp (1204°C) loop tip, box of 10	£110.00
09-AA21	High temp (982°C) vasectomy tip	£13.50
09-AA21/10	High temp (982°C) vasectomy tip, box of 10	£110.00

09-AA25	High temp (1093°C) micro tip	£14.00
09-AA25/10	High temp (1093°C) micro tip, box of 10	£117.00
09-AA27	High temp (1093°C) microloop tip	£14.00
09-AA27/10	High temp (1093°C) microloop tip, box of 10	£117.00
09-AA29	High temp (871°C) micro vasectomy tip	£14.00
09-AA29/10	High temp (871°C) micro vasectomy tip, box of 10	£117.00

Your local medical supplier is just a phone call away. See cover for full details
Prices shown are exclusive of VAT and delivery



AW Elemental Cautery - Handi Light-Duty Model

- Compact pocket cautery set 2.5v standard battery (non-alkaline)
- Robust chrome-brass handle, with exact contact control and teflon connector
- Includes 5 tips - Coagulation ball, Straight tip, Angled tip, Loop and Cold Point
- Tips manufactured from platinum-iridium, long-lasting, non oxidising
- Fully autoclavable handle and tips (excluding batteries)
- Supplied in protective pocket case with batteries
- Suitable for light-duty cosmetic surgery

09-305 Elemental Cautery Handi Set, complete **£254.00**

Disposable Single Patient Use Tips

- A selection of the most commonly used Elemental Handi cautery tips are available for single patient use
- Each tip offers a cost effective alternative to traditional sterilisation methods
- Please note: with single patient use tips it is very important that each tip is gradually brought up to operating temperature
- Each tip is supplied clean, ready for use

09-501-D10	Figure 501 single use tip	£11.99
09-504-D10	Figure 504 single use tip	£11.99
09-505-D10	Figure 505 single use tip	£11.99

Accessories for AW Elemental Light-Duty Handi Unit

09-501	Straight cutter, Blue Tip	£27.50
09-502	Angled, Yellow Tip	£27.50
09-503	Loop cutter, Red Tip	£27.50
09-504	Needle/Cold-point, Green Tip	£27.50
09-505	Co-agulation Ball, White Tip	£27.50
09-401	Replacement Handle	£73.45

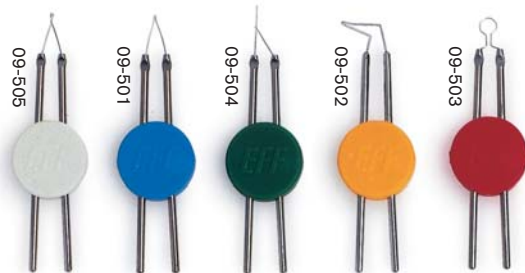

Your local medical supplier is just a phone call away. See cover for full details

Prices shown are exclusive of VAT and delivery

Instruments & Minor Ops Electrosurgery

Aaron A940 High Frequency Dessicator

Designed For Years of Trouble-Free Use

The Aaron 940™ is designed and engineered to be the most reliable and durable desiccator available today.

By incorporating the latest in chip technology and reducing the number of internal parts, thereby generating less internal heat the Aaron 940 is reliable and easy to operate.

Post-procedure and long-term cleanup are simplified by its non-absorbing, non staining, high impact plastic case.

Digital Error Detection

Digital error detection means unsurpassed safety for you and your patient. The Aaron 940™ continuously monitors every aspect of the unit's output. At the sign of any problem the machine instantly disables the output and displays the appropriate error code on the display.

The Bovie® 3-Button Handpiece - Better By Design, Inside And Out

The basic function of a 3-button handpiece is to allow the user to control power up/down and to activate the high frequency desiccator.

- The Aaron 940™ has a technology advantage right in the handpiece: a superbly engineered gold plated collet for superior conductivity.
- The entire handpiece is encapsulated and formed in a high tech polymer that combines comfort with a sure grip.
- The buttons on the handpiece have been designed for superior tactile feel and comfort.
- Fully autoclavable for sterility when you need it, and an easy to clean and durable handpiece all the way around.



More for Less

MORE POWER with 40 watts

HIGHER RESOLUTION IN BI-POLAR MODE increase and decrease in 1/10th watt increments from zero to ten watts

UNIVERSAL POWER with 100—240 VAC... the A940 is a global option

MORE USER FRIENDLY with features that can save you time and money

LESS TO DO with fewer steps to accomplish the same procedures

LESS TO BUY Fewer accessories needed for additional functionality



Common procedures video available free upon request

Available Accessories Include:

- A901 Handpiece
- A910 Handpiece Sheath
- A803 Footswitch
- A812-C Mobile Stand with Bottom Tray, Top Tray, Clamp, and Height Extension
- A812 Mobile Stand
- A808-T Top Tray for A812
- A812-BT Bottom Tray for A812
- A812-E Height Extender for A812
- A813 Table Top Stand
- A837 Wall Mount Kit
- Bipolar Forceps (Reusable)
- Disposable Electrodes
- Reusable Electrodes



A812-C Mobile Stand with Bottom Tray, Top Tray, Clamp, and Height Extension

Spares and accessories

A901	Handpiece (A901)	£126.00
A804	100 Non-Sterile Disposable Sharp Dermal Tips (A804)	£59.00
A806	50 Non-Sterile Disposable Blunt Dermal Tips (A806)	£59.00
A837	Wall Mount Kit (A837)	£18.00
A1202	Dispersive electrode (5)	£28.50
A910	Sheath for Handle (100)	£26.50

Aaron 940	£995.00
Package with Handpiece, Dermal Tips, Wall Mount Kit	

Dermal Tips

A804	Sharp dermal tip – non-sterile (not packaged individually). 100/box	£59.00
A805	Sharp dermal tip – sterile (not packaged individually). 50/box	£62.00
A806	Blunt dermal tip – non-sterile (not packaged individually). 100/box	£59.00
A807	Sharp dermal tip – sterile (not packaged individually). 50/box	£62.00

Tips for Hyfrecator 2000 and Aaron A940 High Frequency Dessicator

7-100-12	£69.00	7-101-12	£69.00
Sharp Electrolase tips non-sterile, box 100		Blunt Electrolase tips non-sterile, box 100	
A804	£59.00	A806	£59.00
Sharp tips, non sterile, box of 100		Blunt tips, non sterile, box of 100	
7-100-8	£69.00	7-101-8	£69.00
Sharp Electrolase tips sterile, box 50		Blunt Electrolase tips sterile, box 50	
A805	£59.00	A807	£59.00
Sharp tips, sterile, box of 50		Blunt tips, non sterile, box of 50	

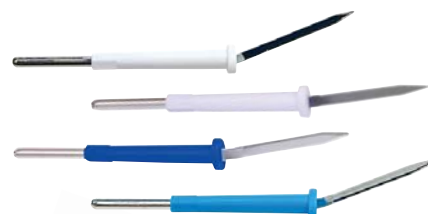

Your local medical supplier is just a phone call away. See cover for full details

Prices shown are exclusive of VAT and delivery

Askina Skin Freezer

- Cryotherapeutic device for treating benign skin changes
- Ideal for treating verrucas and warts
- 150ml canister complete with 50 applicator tips, in a choice of two sizes



AWH100 £66.30

Askina Skin Freeze, 5mm, 50 applications

AWH110 £66.30

Askina Skin Freeze, 2mm, 50 applications

Liquid Nitrogen Storage Dewars

- Vessels for the safe storage of liquid nitrogen over a prolonged period of time
- Full range of specifications to suit individual needs
- An additional withdrawal tube is required to allow the safe dispensing of liquid nitrogen
- Units include dust cover cap
- Withdrawal tube not included as standard



CRY501-5 £496.77

Storage Dewar, 5 litre capacity, holding time 4 to 5 weeks
462(h) x 222(d) mm without withdrawal tube

CRY501-10 £548.30

Storage Dewar, 10 litre capacity, holding time 6 to 8 weeks
546(h) x 260(d) mm without withdrawal tube

CRY501-20sc £690.00

Storage dewar, 20 litre capacity, holding time up to 300 days
627(h) x 368(d) mm without withdrawal tube

CRY501-30 30 litre Storage Dewar £851.61

CRY501-50 50 litre Storage Dewar £1160.00

CRY503 £299.50

Withdrawal tube for 5, 10, 20, 30 and 50 litre units (please state)

CRY501-RB Roller Base for CRY501-20sc £299.00



Brymill 'Cry-Ac' Cryosurgical System

- Hand-held cryosurgical system for effective treatment of dermatological conditions such as warts, verrucae and skin tags
- Minimal secondary tissue damage
- Little or no anaesthetic required
- Convenient to operate jet spray release assembly, ensures accurate and controlled application
- Stainless steel vacuum flask in a choice of 300ml or 500ml versions
- Liquid nitrogen holding time:- 12 hours max (300ml); 20 to 24 hours (500ml)
- Supplied complete with spray apertures A, B, D, 2 x C, and 20 ga. bent spray
- 3 year parts and labour warranty

A full range of attachments and accessories are available on request. Please phone for details.

B700 Cry-Ac System, 500ml (779h x 432d mm), complete £575.00

B800 Cry-Ac 3 System, 300ml (611h x 432d mm), complete £575.00

CRY601 £42.10

Cryotote carrying case for Cry-Ac and Cry-Ac 3, twin lined canvas with carrying handle and accessory pockets

CRY 102-A Aperture A* £15.00

CRY 102-B Aperture B* £15.00

CRY 102-C Aperture C* £15.00

CRY 102-D Aperture D* £15.00

CRY 301-E Super spray E tip £37.00

CRY 103 Original bent spray £41.00

CRY 103-20 75mm x 20g bent spray £27.00

CRY 103-20S 38mm x 20g bent spray £21.00

Please note: other tips available on request

*denotes part of standard package supplied with Cry-Ac units

Optional Accessories

CRY605-S Size 8 small cryo glove £114.34

CRY605-M Size 9 medium cryo glove £114.34

CRY605-L Size 10 large cryo glove £114.34

CRY606 Protective goggles £19.00

CRY 101-AA Acne spray £26.00

Your local medical supplier is just a phone call away. See cover for full details

Prices shown are exclusive of VAT and delivery

Instruments & Minor Ops Instruments

We are pleased to offer a wide range of disposable and reusable instruments suitable for use in the GP surgery and Outpatients Clinic.

A.207.13



A.209.13



A.209.15



A.203.13



A.280.17



D.460.14TC



D.420.12TC



D.500.18



A.995.18



A.283.18



Scissors	Disposable	Price	Reusable	Price
Dressing blunt/blunt 5"/12.5cm straight	DA.205.13	£1.75	A.205.13	£3.00
Dressing sharp/blunt 5"/12.5cm straight	DA.207.13	£1.75	A.207.13	£3.00
Dressing sharp/sharp 5"/12.5cm straight	DA.209.13	£1.75	A.209.13	£3.00
Dressing blunt/blunt 6"/15cm straight			A.205.15	£4.00
Dressing sharp/blunt 6"/15cm straight			A.207.15	£4.00
Dressing sharp/sharp 6"/15cm straight			A.209.15	£4.00
Dressing blunt/blunt 7"/18cm straight			A.205.18	£5.00
Dressing sharp/blunt 7"/18cm straight			A.207.18	£5.00
Dressing sharp/sharp 7"/18cm straight			A.209.18	£5.00
Dressing blunt/blunt 5"/13cm curved			A.215.13	£4.00
Dressing sharp/blunt 5"/13cm curved			A.217.13	£4.00
Dressing sharp/sharp 5"/13cm curved			A.219.13	£4.00
Dressing blunt/blunt 6"/15cm curved			A.215.15	£5.00
Dressing sharp/blunt 6"/15cm curved			A.217.15	£5.00
Dressing sharp/sharp 6"/15cm curved			A.219.15	£5.00
Dressing blunt/blunt 7"/18cm curved			A.215.18	£6.10
Dressing sharp/blunt 7"/18cm curved			A.217.18	£6.10
Dressing sharp/sharp 7"/18cm curved			A.219.18	£6.10
Dressing scissor sharp/blunt 5"/13cm straight with clip			A.203.13	£5.00
Open bow dissecting scissor 5"/13cm			S.200.13	£3.00
Mayo straight, 5.5"/14cm			A.280.14	£5.00
Mayo straight, 6.5"/17cm	DA.280.17	£1.75	A.280.17	£5.40
Mayo straight, 7.5"/19cm			A.280.19	£5.90
Mayo straight, 9"/23cm	DA.280.23	£3.25		
Mayo curved, 5.5"/14cm			A.281.14	£5.40
Mayo curved, 6.5"/17cm	DA.281.17	£1.75	A.281.17	£5.90
Mayo curved, 7.5"/19cm	DA.281.19	£3.00	A.281.19	£6.10
Metzenbaum 5.5"/14cm straight	DA.282.14	£1.75	A.282.14	£4.90
Metzenbaum 7"/18cm straight			A.282.18	£5.40
Metzenbaum 8"/20cm straight			A.282.20	£5.70
Metzenbaum 5.5"/14cm curved	DA.283.14	£1.75	A.283.14	£4.90
Metzenbaum 7"/18cm curved			A.283.18	£5.40
Metzenbaum 8"/20cm curved			A.283.20	£5.70

Your local medical supplier is just a phone call away. See cover for full details

Prices shown are exclusive of VAT and delivery



Scissors				
Description	Disposable	Price	Reusable	Price
McIndoe scissors straight, 18cm	DA.743.18	£3.25		
McIndoe scissors curved, 18cm	DA.744.18	£3.25		
Suture scissor/hookpoint	DA.745.10	£1.00		
Model USA umbilical scissor	DA.655.10	£2.90	A.655.10	£8.95
Umbilical scissors, 16cm	DA.655.16	£2.90		
Iris straight, 4.5"/11cm	DA.730.11	£1.25	A.730.11	£3.70
Iris curved, 4.5"/11cm	DA.731.11	£1.25	A.731.11	£3.70
Strabismus straight, 4.5"/11cm	DA.740.12	£1.99	A.740.12	£3.80
Strabismus curved, 4.5"/11cm	DA.741.12	£1.99	A.741.12	£3.70
Spencer Stitch, 5"/13cm			A.756.13	£3.60
Littauer stitch, 5.5"/14cm			A.760.14	£3.60
Lister bandage 5"/12.5cm	DA.995.14	£1.40	A.995.14	£4.40
Lister bandage 7"/17cm	DA.995.18	£2.30	A.995.18	£5.40
Tough cut universal scissor 8"/20cm	J.100.20DISP	£1.50		
Sims uterine, 9"/23cm	DA.801.23	£3.10	A.801.23	£9.30
Tissue scissors	DA.742.12	£1.75		
Supersnip sharp/sharp 12.5cm plastic handle scissors	DA.980.12	£1.00		
Supersnip blunt/blunt 12.5cm plastic handle scissors	DA.981.12	£1.00		
Supersnip sharp/blunt scissors 12.5cm	DA.982.12	£1.00		
Plastic clamp scissors	DA.983.10	£1.00		

Needle Holders				
Description	Disposable	Price	Reusable	Price
Crile Wood, 6"/15cm	DD.410.15	£2.09	D.410.15	£7.10
Crile Wood, 6"/15cm with TC inserts			D.410.15TC	£22.50
Derf 4.75"/12cm	DD.420.12	£1.79	D.420.12	£7.10
Derf 4.75"/12cm with TC inserts			D.420.12TC	£22.50
Gillies 6.25"/16cm			D.450.16	£7.10
Gillies 6.25"/16cm with TC inserts			D.450.16TC	£22.50
Kilner 5.25"/13.5cm	DD.460.14	£1.79	D.460.14	£7.10
Kilner 5.25"/14cm with TC inserts			D.460.14TC	£22.50
Mayo 12cm	DD.500.12	£1.90		
Mayo Hegar 6"/15cm	DD.500.15	£2.09	D.500.15	£7.10
Mayo Hegar 6"/15cm with TC inserts			D.500.15TC	£22.50
Mayo 16cm	DD.500.16	£2.30		
Mayo Hegar 7"/18cm			D.500.18	£8.10
Mayo Hegar 7"/18cm with TC inserts			D.500.18TC	£24.50
Mayo 20cm	DD.500.20	£3.60		
Olsen Hegar 5.5"/14cm			D.550.14	£9.20



Your local medical supplier is just a phone call away. See cover for full details
 Prices shown are exclusive of VAT and delivery

Instruments & Minor Ops Instruments



B.100.13



B.150.13



B.160.15



B.165.15



B.180.15



B.201.12



B.230.13



B.250.15



B.394.12



B.395.11



B.510.10



B.555.10

Dissecting Forceps

Description	Disposable	Price	Reusable	Price
Adson serrated, 5"/12.5cm	DB.100.13	£1.15	B.100.13	£4.20
Adson 1:2 teeth, 5"/12.5cm	DB.110.13	£1.15	B.110.13	£4.40
Block end, 5"/13cm			B.150.13	£3.40
Block end, 6"/15cm			B.150.15	£3.60
Block end, 7"/18cm			B.150.18	£3.80
Block end, 8"/20cm			B.150.20	£4.00
Turnover end, 5"/13cm	DB.160.13	£1.75	B.160.13	£3.00
Turnover end, 6"/15cm			B.160.15	£3.30
Model USA, 1:2th, 5"/13cm			B.165.13	£3.60
Model USA, 1:2th, 6"/15cm			B.165.15	£3.90
Gillies, 1"2th, 6"/15cm	DB.180.15	£1.71	B.180.15	£4.10
Iris, straight, 4.5"/11cm	DB.200.12	£1.09	B.200.12	£4.00
Iris, curved, 4.5"/11cm			B.201.12	£4.00
Iris, straight, 1:2th, 4.5"/11cm	DB.210.12	£1.09	B.210.12	£4.00
Iris, curved, 1:2th, 4.5"/11cm			B.211.12	£4.00
Lane, 1:2th, 5"/13cm			B.230.13	£5.00
Lane, 1:2th, 7"/18cm			B.230.18	£6.90
McIndoe, 6"/15cm	DB.250.15	£1.29	B.250.15	£4.40
Treves, 1:2th, 5"/12.5cm	DB.350.13	£1.29	B.350.13	£4.20
Hunter Splinter, straight, 4.5"/11cm			B.394.12	£4.20
Hunter Splinter, straight, 14.5cm	DB.394.14	£2.50		
Hunter Splinter, curved, 14.5cm	DB.395.14	£2.50		
Martin Splinter, straight, 4.5"/11cm			B.395.11	£4.20
Epilation, with straight end, 3.5"/9cm			B.500.10	£4.60
Epilation, with oblique end, 3.5"/9cm			B.510.10	£4.60
Watchmaker No.5			B.555.10	£4.60

Your local medical supplier is just a phone call away. See cover for full details
Prices shown are exclusive of VAT and delivery



C.321.13



C.310.14



C.330.12



C.470.15



C.520.13

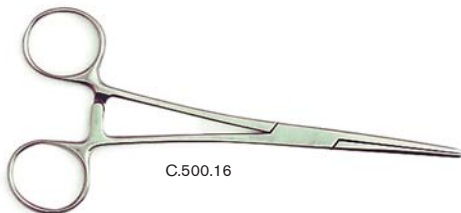

C.500.16



C.521.15



C.590.15

Artery Forceps		Disposable	Price	Reusable	Price
Description					
Crile, straight, 5.5"/14cm		DC.310.14	£1.59	C.310.14	£5.60
Crile, curved, 5.5"/14cm		DC.311.14	£1.59	C.311.14	£5.60
Dunhill, curved, 5"/13cm				C.321.13	£5.60
Halstead Mosquito, straight, 12.5cm		DC.330.12	£1.79	C.330.12	£5.10
Halstead Mosquito, curved, 12.5cm		DC.331.12	£1.79	C.331.12	£5.10
Kocher, straight, 1:2th, 5"/13cm				C.470.13	£5.60
Kocher, straight, 1:2th, 6"/15cm				C.470.15	£6.10
Kocher, curved, 1:2th, 5"/13cm				C.471.13	£5.80
Kocher, curved, 1:2th, 6"/15cm				C.471.15	£6.10
Mayo, curved, 6"/15cm				C.501.16	£6.10
Spencer Wells, straight, 12.5cm		DC.520.13	£1.89	C.520.13	£5.60
Spencer Wells, straight, 6"/15cm				C.520.15	£5.80
Spencer Wells, straight, 7"/18cm		DC.520.18	£2.45	C.520.18	£6.10
Spencer Wells, straight, 8"/20cm		DC.520.20	£2.79	C.520.20	£6.20
Spencer Wells, straight, 9"/23cm		DC.520.23	£3.29	C.520.23	£6.50
Spencer Wells, curved, 13cm		DC.521.13	£2.10	C.521.13	£5.90
Spencer Wells, curved, 14cm		DC.521.14	£2.10		
Spencer Wells, curved, 15cm		DC.521.15	£2.10	C.521.15	£6.10
Spencer Wells, curved, 7"/18cm				C.521.18	£6.20
Spencer Wells, curved, 8"/20cm				C.521.20	£6.40
Spencer Wells, curved, 9"/23cm				C.521.23	£6.50
Tubing clamp, 6"/15cm				C.590.15	£8.50

Your local medical supplier is just a phone call away. See cover for full details

Prices shown are exclusive of VAT and delivery

Instruments & Minor Ops Instruments



Description	Retractors and other Miscellaneous Instruments			
	Disposable	Price	Reusable	Price
Gillies skin hook, 6.5"/17cm			H.120.17	£5.60
Single hook retractor, sharp, 6.25"/16cm			H.100.16	£5.60
Single hook retractor, blunt, 6.25"/16cm			H.105.16	£5.60
Double prong retractor, sharp, 6.25"/16cm			H.136.02	£6.70
Double prong retractor, blunt, 6.25"/16cm			H.137.02	£6.70
Kilner catspaw retractor, 6"/15cm			H.130.15	£6.70
Volkman D/E curette, 5"/13cm			K.100.30	£7.70
Volkman DE scoop, 8.5"/21cm			K.105.30	£9.00
McDonald dissector, 7.5"/19cm			K.166.19	£14.95
Towel Clip, cross action, 3"/7.5cm			C.800.08	£3.30
Backhaus towel clip, 3.75"/11cm			C.880.08	£4.40
Jones towel clip, 3.75"/9cm	DC.850.09	£3.59	C.850.09	£7.80
Brodie Dissector 2"/5cm			Z.100.20	£7.80
Double ended probe, 6"/15cm			Z.200.15	£3.30
Trocar and cannula, set of 3 sizes			Z.100.40	£19.40
Hormone implant trocar			Z.100.80	£28.60
Ring cutter with blade			Z.100.10	£24.50
Spare blade for ring cutter			Z.100.15	£12.30



Your local medical supplier is just a phone call away. See cover for full details
Prices shown are exclusive of VAT and delivery

Ear, Nose and Throat



C.750.15 Lister Sinus Forceps 6"	£5.10
G.150.08 Tilley Forceps 3"	£8.50
G.140.09 Hartmann Crocodile Forceps 3.5"	£23.50
G.140.14 Hartmann Crocodile Forceps 5.5"	£27.60
G.180.07 Quire Foreign Body Forceps 3"	£11.20
G.160.08 Wilde Aural Forceps 2.5"	£6.90
G.290.20 Magill ET Forceps 8", child	£9.20
G.290.24 Magill ET Forceps 9.5", adult	£10.50
G.200.14 Jobson Horne Probe 5.5"	£4.20
G.220.12 Gross Hook, double-ended	£6.20
G.210.16 Wool Carrier	£5.90
G.100.04 Aural Syringe 4 o/z, + 2 nozzles	£12.30
G.110.00 Bacon Aural Syringe	£16.40

G.120.00 Noots Aluminium Ear Tank	£9.20
G.240.00 Thudicum Nasal Speculum, size 0	£4.10
G.240.01 Thudicum Nasal Speculum, size 1	£4.10
G.240.02 Thudicum Nasal Speculum, size 2	£4.10
G.240.03 Thudicum Nasal Speculum, size 3	£4.10
G.240.04 Thudicum Nasal Speculum, size 4	£4.10
G.240.05 Thudicum Nasal Speculum, set of 5	£14.80
G.600.00 Gardiner Brown Tuning Fork C128	£27.90
G.600.01 Gardiner Brown Tuning Fork C256	£27.90
G.600.02 Gardiner Brown Tuning Fork C512	£27.90
G.230.14 Laryngeal Mirror 14mm	£7.20
G.230.20 Laryngeal Mirror 20mm	£7.20
G.190.01 Ziegler Head Mirror	£33.70

Disposable Thudichum Nasal Specula



Convenient and easy to use disposable Thudichum nasal specula. All 5 popular sizes are manufactured from atraumatic patient friendly plastic polymer which is extremely robust.

Designed for single patient use to avoid any chance of cross infection. May be disposed of in any convenient Sharps Bin.

GD.240.01	Size 1 sterile disposable Thudichum speculum	£0.90
GD.240.02	Size 2 sterile disposable Thudichum speculum	£0.90
GD.240.03	Size 3 sterile disposable Thudichum speculum	£0.90
GD.240.04	Size 4 sterile disposable Thudichum speculum	£0.90
GD.240.05	Size 5 sterile disposable Thudichum speculum	£0.90

Pro-Ent

The Pro-Ent range of spoons and ring curettes provide a cost effective method of preventing cross infection. Each type is supplied clinically clean in a pack of 25. The rounded plastic tips greatly reduce the risk of trauma.

The Blue range is double ended and provides a ring curette of 3.0mm O.D. and 2.0mm I.D. The opposing end provides an angled ring curette of 4.0mm O.D. and 3.0mm I.D. The overall length is 17.5cm

The Green range is double ended and provides 2 spoons of the following sizes, 4mm x 5mm and 2.5mm x 3.0mm. The overall length is 17.5cm



GD.190.01	Blue Pro-Ent ring curette. Double ended, Pack of 25	£28.75 (£1.15p each)
GD.190.02	Green Pro-Ent spoon. Double ended, Pack of 25	£28.75 (£1.15p each)

Your local medical supplier is just a phone call away. See cover for full details

Prices shown are exclusive of VAT and delivery

Instruments & Minor Ops Instruments Chiropody

AW Chiropody Instruments

99.50.001B



99.51.002B



99.55.001B

99.52.001B



99.58.000

99.58.010

This selection of AW Chiropody instruments represents a few of the most commonly used types and styles.

A more extensive range of instruments is available on request.

All AW Chiropody instruments are backed by a

3 year guarantee

99.50.001B	Nail Nipper, end cutting S/S 5.5" double spring	£27.30
99.51.002B	Nail Nipper, double spring S/S 5.5"	£23.30
99.52.001B	Nail Nipper, barrel spring 4.5"	£15.00
99.55.001B	Ingrown Nail Nipper 5", double spring	£19.20
99.58.000	Compound Action Nail Nipper	£40.30
99.58.010	Thwaites Nail Splitter	£26.80

98.01.015	Chiropody File, large	£17.30
98.02.001	Chiropody Gouge, 1mm	£12.00
98.02.002	Chiropody Gouge, 2mm	£12.00
98.03.001	Chiropody Spatula, double ended	£9.70
98.03.002	Chiropody Spatula/Excavator, double ended	£9.70
98.03.003	Chiropody Probe/Excavator, double ended	£10.60
98.03.004	Blacks Chiropody File, double ended	£11.90
98.04.004	Chiropody File with angled end	£9.70
98.04.005	Chiropody Chisel	£9.30
98.04.006	Chiropody Scoop/Excavator	£9.30



98.02.002

98.01.015

98.03.003

98.03.002

98.03.001

98.04.004

98.03.004

98.04.006

98.04.005

Your local medical supplier is just a phone call away. See cover for full details

Prices shown are exclusive of VAT and delivery

Instrument Cleaning Brushes

- This range of brushes is perfect for getting to difficult to reach and intricate parts of your instruments for cleaning prior to sterilisation. Each brush is manufactured from twisted mild steel with nylon bristles. A full range of sizes are available.
- Not autoclaveable

73-301.03 £37.50
 Fine lumen cleaning brush 245 x 65 x 3mm, pack 10

73-306.13 £22.80
 Standard cleaning brush 215 x 60 x 13mm, pack 10

73-324.35 £43.90
 Large cleaning brush with natural bristle end 360 x 140 x 35mm, pack 10

73-327.60 £85.40
 Extra large cleaning brush with natural bristle end 500 x 180 x 60mm, pack 10



Rusch Silkospray

- Rusch Silkospray dual purpose silicone spray
- For use in the lubrication of PVC and red rubber catheters and intubations, prior to insertion
- Also for lubricating instrument joints, ensuring smooth operation and extended life
- 500ml per can

R556000 £14.80
 Rusch Silkospray 500ml per can



Mirror Warmer - Ideal for ENT departments

- Increases patient comfort
- Warms up rapidly
- Based on contact-less infrared technology
- Complete set includes: mirror warmer, transformer and cables

10.200 Mirror Warmer £595.00



Your local medical supplier is just a phone call away. See cover for full details
 Prices shown are exclusive of VAT and delivery

Instruments & Minor Ops Instrument Sets

Minor Surgery Instrument Set

- Complete range of high quality instrumentation suited to minor surgery applications, including:-
 - Dressing Scissors 6" sharp/blunt, curved
 - Iris Scissors 4.5" straight
 - Mayo Scissors 5.5" straight
 - Littauer Stitch Scissors 5.5"
 - Gillies Dissecting Forceps 1:2 teeth 6"
 - Dissecting Forceps 5" block end
 - Halstead Mosquito Artery Forceps 5" straight
- Mayo Hegar Needle Holder 6" with TC inserts and gold plated handles
- Gillies Skin Hook
- Kilner Cats Paw Retractor
- McDonald Dissector
- Volkman Scoop, medium
- No.3 scalpel handle
- Probe
- All 14 instruments are supplied complete in a fine grain leather instrument case with internal washable compartments
- 3 year warranty



S.900.01 Minor Surgery instrument set, complete **£178.50**

Suturing Set

- A complete instrument set designed specifically for suturing and wound closure, in one handy pack
- The suturing set is supplied in a fine grain leather instrument case with removable and washable compartments, and includes:-
 - No.3 scalpel handle
 - Dressing scissors 5" sharp/blunt
 - Iris scissors 4.5" straight
 - Kilner needle holder TC Gold
 - Crile-Wood needle holder 6"
 - Gillies dissecting forcep 6" 1:2 teeth
 - Iris dissecting forcep 4.5" curved
 - Halsted-Mosquito artery forcep 5" straight
 - Halsted-Mosquito artery forcep 5" curved



S.920.00 Suturing Set **£87.80**

Scissor Set

- Comprehensive selection of scissors to suit all your surgery requirements for surgery, nursing, first aid and general use.
- The scissors set includes the following instruments:-
 - Lister bandage scissors 5.5"
 - Lister bandage scissors 7.5"
 - Mayo scissors 5.5" straight
 - Iris scissors 4.5" straight
 - Iris scissors 4.5" curved
 - Sims uterine scissors 9" curved
 - Littauer stitch scissors 5.5"
 - Metzenbaum scissors 7" straight
 - Dressing scissors sharp/blunt 5" straight
 - Dressing scissors sharp/blunt 6" curved
- All 10 scissors are supplied with a fine grain leather instrument case, with removable washable internal compartments



S.910.00 Scissor Set **£89.30**

Dermatology Instrument Set

- The comprehensive dermatology instrument pack offers the widest selection of instruments for all your dermatological needs
- Ideal for minor surgery techniques, suturing, examination and treatment, the dermatology instrument set includes:-
 - No. 3 scalpel handle
 - No. 7K extra fine scalpel handle
 - Martin round bodied scalpel handle
 - Metzenbaum scissor 5.5" straight
 - Iris scissor 4.5" curved
 - Iris scissor 4.5" straight
 - Mayo scissor 5.5" straight
 - Noyes spring scissor 4.5" extra fine
 - Adson dissecting forcep 5" serrated
 - Adson dissecting forcep 5" 1:2 teeth
 - Gillies dissecting forcep 6" 1:2 teeth
 - McIndoe dissecting forcep 6"
 - Standard dressing forcep 5"
 - Epilation forcep 4.5" straight end
 - Halsted Mosquito artery forcep 5" curved
 - Halsted Mosquito artery forcep 5" straight
 - Mayo-Hegar needle holder 6"
 - Gillies skin hook
 - Alms self retaining retractor 4"



S.925.00 Dermatology Instrument Set **£232.50**

Your local medical supplier is just a phone call away. See cover for full details

Prices shown are exclusive of VAT and delivery

Suture Pack Standard

- 1 x Kilner needle holder 13.5cm
- 1 x Treves dissecting forcep toothed 12.5cm
- 1 x turned over end forcep 12.5cm
- 1 x Iris scissor straight 11 cm



PP16001

£3.50

Suture Pack Fine Plus

- 1 x Kilner needle holder 13.5cm
- 1 x Iris scissor straight 11 cm
- 1 x Iris dissecting forcep non-toothed 10cm
- 1 x Iris dissecting forcep toothed 10cm
- 3 x non woven swabs
- 2 x dressing towels
- 1 x plastic tray with integrated gallipots



PP16073

£4.10

Non Scapel Vasectomy Pack

- 1 x Li ring forcep 15.5cm
- 1 x haemostatis forcep 15.5cm



PP16026

£9.20

Suture Pack Standard Plus

- 1 x Kilner needle holder 13.5cm
- 1 x Treves dissecting forcep toothed 12.5cm
- 1 x turned over end forcep 12.5cm
- 1 x Iris scissor straight 11 cm
- 2 x dressing towels
- 3 x non woven swabs
- 2 x gallipots
- 1 x pulp tray



PP16046

£5.30

Suture Pack Soft

- 3 x non woven swabs
- 2 x dressing towels
- 2 x gallipots



PP16053

£2.00

Non Scapel Vasectomy Pack

- 1 x Li ring forcep 15.5cm
- 1 x haemostatis forcep 15.5cm
- 1 x Gillies toothed forcep 15cm
- 1 x McIndoe non toothed forcep 15cm
- 2 x Halstead mosquito forceps curved 12.5cm
- 1 x Rampley sponge forcep 18cm
- 1 x pulp tray



PP16076

£15.60

Suture Pack Fine

- 1 x Kilner needle holder 13.5cm
- 1 x Iris dissecting forcep non-toothed 10cm
- 1 x Iris scissor straight 11cm
- 1 x Iris dissecting forcep toothed 10cm



PP16002

£3.45

Minor Operations Pack Silver

- 1 x Brad Parker scalpel handle No. 3
- 1 x Kilner needle holder 13cm
- 2 x Halstead mosquito forceps straight 12.5cm
- 1 x Gillies dissecting forcep toothed 15cm
- 1 x McIndoe forcep non toothed 15cm
- 1 x Iris scissor straight 11cm
- 1 x Iris scissor curved 11cm
- 2 x gallipots
- 2 x dressing towels
- 5 x non woven swabs
- 1 x large pulp tray



PP16008

£7.65

IUCD Pack with Sound

- 1 x Cusco speculum medium
- 1 x Rampley sponge holder 24cm
- 1 x Teale Vusellum forcep curved 24cm
- 1 x Mayo scissors curved 19cm
- 1 x Galabin uterine sound
- 5 x cotton balls
- 1 x gallipot
- 1 x towel dressing
- 1 x kidney dish



PP16010

£12.00

Your local medical supplier is just a phone call away. See cover for full details

Prices shown are exclusive of VAT and delivery

Instruments & Minor Ops Disposables

Prep Razors



1131219 £22.30 per box
Box of 100 Prep Razors, 2 blades with protective cap, non sterile

Wooden Applicator



- Approximately 150mm x 2.2mm
- Single cotton bud
- OD 5-5.5mm, 12mm bud end
- 100 pieces per bag

1030128 £8.90 per 100
Wooden applicator in a bag of 100

Latex Rolled Finger Cots



- Available in 4 sizes
- Powderfree

1131971	Size 2 finger cot, pack of 100	£2.75
1131972	Size 3 finger cot, pack of 100	£2.75
1131973	Size 4 finger cot, pack of 100	£2.75
1131975	Size 5 finger cot, pack of 100	£2.75

Urine Cups

- 125cc graduated unbreakable cup with frosted field for writing
- Snap on lid with pull off tab on screw on lid



1131101/10	Snap on red cap, pack of 10, non sterile	£2.00
1131202/10	Screw on green cap, pack of 10, non sterile	£2.20
1131203/10	Screw on yellow cap, sterile, pack of 10	£3.30
1131003/10	Specimen container with red screw on cap 60cc, 35 x 70mm, pack of 10	£2.00

Alcohol Swabs

- Alcohol swab set for cleansing, 70% Isopropylalcohol
- Single packed
- Folded size 3 x 3cm, unfolded 6 x 3cm
- Sold in box of 100

Swab Dispenser

- Alcohol swab dispenser with 150 swabs 44 x 44mm soaked in 70% Isopropylalcohol
- Empty container can be used for disposable needles



1131897	Box of 100 alcohol swabs	£3.00 per 100
1131920	Swab container and 150 swabs	£9.45



Tongue Depressors

- Wooden tongue depressors, in boxes of 100



AWD-TD100 £1.10 per 100
Tongue Depressors

Your local medical supplier is just a phone call away. See cover for full details

Prices shown are exclusive of VAT and delivery

Disposables Instruments & Minor Ops

Dissecting Instrument Set



- All purpose dissecting kit, ideal for students and medical schools
- Contents include:-
 - Scalpel Handle
 - Scissors sharp/blunt 5" straight
 - Open Bow Dissecting Scissors
 - Sharp Dissecting Forceps
 - Dissecting Forceps T.O.E
 - Probe blunt/straight
 - Probe blunt/angled
 - Probe sharp/straight
 - Section Lifter
- Kit supplied complete in Canvas Dissecting Kit Roll

S.350.01 Dissecting Instrument Set, complete **£19.20**

Generic accessories

Reduce the running costs of your Propulse ear syringe

A range of cost effective generic consumables for the Propulse and Propulse NG machines, recognised trade names of Mirage Medical Ltd.

Single use, ear tip



190.50.000

190.50.000 **£39.50**

Accujet single patient ear tips for use with Propulse II and III ear syringe (100)

19.50.000NG **£41.50**

Accujet single patient ear tips for use with Propulse NG ear syringe complete with adaptor (100)

190.50.000 **£1.25**

Single patient use adaptor for Accujet tips to Propulse NG ear syringe

190.00.020/5 **£18.70**

Ear syringe Chlor Hex cleaning tablets for ProJet and Propulse machines

190.60.100 **£34.50**

Pack of 100 single patient use ear tips for ProJet 101 Ear Irrigator

Chelmed Disposable Noots ear tank

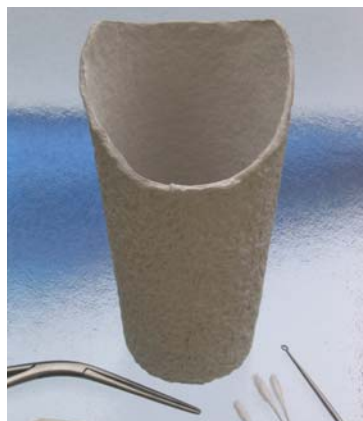

- Fully maceratable paper pulp
- Reduces risk of cross contamination
- Reduces cleaning time
- Sold in handy packs of 50 and 100

190.50.600/50 Chelmed Disposable Noots ear tank (50) **£30.10**

190.50.600/100 Chelmed Disposable Noots ear tank (100) **£56.10**

Plastic noots ear tank - reusable and disposable



190.50.500 Plastic noots ear tank **£6.20**

190.50.500D Plastic noots ear tank - disposable (10) **£10.20**

190.50.500D/100 Plastic noots ear tank - disposable (100) **£56.10**

Pulp Kidney Dish

- Disposable grey millboard kidney dish
- 25cm length



1091502 **£28.60**

Disposable Kidney Dish, pack of 300

Your local medical supplier is just a phone call away. See cover for full details

Prices shown are exclusive of VAT and delivery

Instruments & Minor Ops Holloware

Stainless Steel Holloware



300.20.180 Gallipot 1oz, 5c dia.	£4.20	300.20.087 Dressing Jar with lid, 6cm high x 10cm dia.	£37.80
300.20.190 Gallipot 2oz, 7cm dia.	£4.40	300.20.090 Dressing Jar with lid, 15cm high x 10cm dia.	£18.40
300.20.200 Gallipot 3oz, 7cm dia.	£4.60	300.20.240 Lotion Bowl, 0.4 litre	£4.90
300.20.210 Gallipot 4oz, 8.5cm dia.	£5.40	300.20.255 Lotion Bowl, 1.0 litre	£6.90
300.20.220 Gallipot 6oz, 8.5cm dia.	£5.90	300.20.260 Lotion Bowl, 2.0 litre	£10.10
300.20.230 Gallipot 9oz, 10.5cm dia.	£6.10	300.30.010 Instrument Tray 20 x 15 x 1.8cm (shallow)	£9.00
300.20.232 Gallipot 12oz, 10.5cm dia.	£6.40	300.30.020 Instrument Tray 24 x 20 x 4cm	£11.75
300.10.090 Kidney Dish, 15cm	£5.10	300.30.040 Instrument Tray 30 x 20 x 3.5cm	£14.00
300.20.000 Kidney Dish, 17cm	£5.90	300.30.150 Instrument Tray with Lid, 16 x 10 x 3cm	£30.60
300.20.010 Kidney Dish, 20cm	£6.90	300.30.160 Instrument Tray with Lid, 22 x 15 x 5cm	£37.80
300.20.020 Kidney Dish, 25cm	£8.20	300.30.180 Instrument Tray with Lid, 30 x 20 x 5cm	£49.00
300.20.030 Kidney Dish, 27.5cm	£10.00	300.20.410 Measuring Jug 1.0 litre	£15.30

Your local medical supplier is just a phone call away. See cover for full details

Prices shown are exclusive of VAT and delivery

Bandage Applicators Instruments & Minor Ops

Polypropylene Ware in Blue



310.10.010 Kidney Dish 15cm	£1.70
310.10.020 Kidney Dish 20cm	£2.05
310.10.030 Kidney Dish 25cm	£2.20
310.10.050 Gallipot 1oz	£0.70
310.10.060 Gallipot 3oz	£0.90
310.10.070 Gallipot 9oz	£1.20
310.20.010 Lotion Bowl 10cm	£1.30
310.20.020 Lotion Bowl 15cm	£1.90
310.20.030 Lotion Bowl 20cm	£3.10
310.20.050 Instrument Tray 15cm x 20cm	£4.50
310.20.060 Instrument Tray 25cm x 30cm	£9.40
310.30.050 Measuring Jug 2 pint / 1 litre	£3.80

Tubular Bandage Applicators



130.00.001 Sugar Tong Applicator, size 00, bandage 00 or 01	£4.30
130.00.002 Sugar Tong Applicator, size 0, bandage 01 or 12	£4.30
130.00.003 Wire Frame Applicator, size C 3cm, bandage 01	£8.60
130.00.004 Wire Frame Applicator, size D 4.5cm, bandage 12	£8.60
130.00.005 Wire Frame Applicator, size E 9cm, bandage 34	£14.30
130.00.006 Wire Frame Applicator, size F 12cm, bandage 56	£14.30
130.00.007 Wire Frame Applicator, size FX 15cm, bandage 56 or 78	£17.40
130.00.008 Wire Frame Applicator, size G 17cm, bandage 56 or 78	£17.40
130.00.009 Wire Frame Applicator, size H 19cm, bandage 78	£19.40
130.00.010 Wire Frame Applicator, size J 23cm, bandage T1 or T2	£19.40
130.00.011 Wire Frame Applicator, size K 25.5cm, bandage T1 or T2	£23.50
130.00.015 Wire Frame Applicator, shuttlecock, bandage 00, 01 or 12	£12.30

Your local medical supplier is just a phone call away. See cover for full details

Prices shown are exclusive of VAT and delivery



Opticlar VisionMax Surgery Lighting

Medical lighting is extremely important and Opticlar VisionMax LED surgery lighting is practical, cost effective and provides the type of light that ensures that the medical practitioner can perform their examinations and minor procedures with the optimum lighting.

OPTICLAR VISIONMAX 3 LED Examination Light

This 3W LED surgery light is our base model yet still has impressive specifications and is ideal for general practice use. It is ideal for routine gynaecological examinations due to its extremely compact light pipe and slim head with focusing capability.

The 3W LED has been designed for longevity and has an average life expectancy of over 50,000 hours. The focusing light remains very cool and is ideal for gynae examinations that require the light head to be close to the examiner and/or patient.

In contrast the light can also be used for general examinations or minor surgery due to its wide focusing range from 10mm to 110mm with a bright homogenous spot irrespective of size. The light pipe is approximately 120cm in length and is armoured for durability. The light is available with a choice of Wall mount, Universal table mount or mobile stand mount. Wall rail systems are also available allowing the luminaire to be used for 'top to tail' examinations.

- Light source: LED
- Power: 3W
- Light intensity: 40,000 lux at 30cm
- Light field: Adjustable spot light range of 10 -110mm
- Colour temp: approx. 6000k
- Bulb Life: 50,000 hours
- Switch: On transformer
- Length of light pipe: circa 120cm
- Working distance: 420mm
- Weight: 1.2kg



138

520.000.010 OPTICLAR 3W led exam light with focusing ring. Flexible arm. Wall Mount.	£335.00
520.010.012 OPTICLAR 3W led exam light with focusing ring. Flexible arm. Desk/Table Mount	£350.00
520.000.014 OPTICLAR 3W led exam light with focusing ring. Flexible arm. Mobile Trolley Mount	£415.00
520.000.016 OPTICLAR 3W led exam light with focusing ring. Flexible arm. Wall Rail Mount	£365.00



Wall Mount



Table Mount



Wall Rail Mount



Trolley Mount

Your local medical supplier is just a phone call away. See cover for full details

Prices shown are exclusive of VAT and delivery

Opticlar VisionMax 5 LED Examination Light

This 5W LED has been designed to provide the best possible illumination for demanding situations such as Sexual Health Clinics and other applications that require very bright lighting and offer compact and unobtrusive dimensions.

The 5W LED provides illumination comparable with significantly more expensive lights and the slim head remains cool to the touch for long periods of time and has the added benefit of providing a homogenous focusable light field.

It has been designed for longevity and with its excellent heat management has a rated life of over 50,000 hours of continuous use.

In practical terms this means no more bulb replacement with significantly reduced running costs and downtime.

Not only is the VisionMax 5 suitable for difficult Obs/Gynae applications due to its light intensity and wide focusing ability from 10mm to 200mm VM5 is ideal for minor ops and provides a clearly defined homogenous spot irrespective of spot size.

The light pipe is approximately 120cm in length and is armoured for durability.

The light is available with a choice of Wall mount, Universal table mount or mobile stand mount. Wall rail systems are also available allowing the luminaire to be used for 'top to tail' examinations.



- Light source: LED
- Power: 5W
- Light intensity: 60,000 lux at 30cm
- Light field: Adjustable spot light range of 10 - 200mm
- Colour temp: approx. 6000k
- Bulb Life: 50,000 hours
- Switch: On transformer
- Length of light pipe: circa 120cm
- Working distance: 420mm
- Weight: 1.3kg

520.010.010 OPTICLAR 5W led exam light with focusing ring. Flexible arm. Wall Mount	£425.00
520.010.012 OPTICLAR 5W led exam light with focusing ring. Flexible arm. Desk/Table Mount	£465.00
520.010.014 OPTICLAR 5W led exam light with focusing ring. Flexible arm. Mobile Trolley Mount	£499.00
520.010.016 OPTICLAR 5W led exam light with focusing ring. Flexible arm. Wall Rail Mount	£480.00



Wall Mount



Table Mount



Wall Rail Mount



Trolley Mount

Your local medical supplier is just a phone call away. See cover for full details

Prices shown are exclusive of VAT and delivery

Lighting LED Surgery Lamp

Series 5 OSRAM-LED Mobile Lamp

Our most energy efficient lamp producing approximately 70,000 lux luminous power and 30 Watt energy consumption. Its adjustable 4 step dimmer guarantees excellent visibility.

- Superb light quality with temperature controlled "Osram LED"
- Generates primary light with a very high colour rendering, long lifetime and consistent light quality
- Multiple light mixture and gloss metal reflector generate a homogenous light and shadow free, non-glare working area
- Exceptional hygiene properties developed through polished, closed and seamless surfaces (No louvres) combined with a sterilisable handle.
- Comfortable handling due to weight-balance, low-friction and cardanic positioning

Technical details

- Lamp colour White
- Bulb type LED: with cool light reflector
- Bulb 12v/50w with 10% divergence LED 3x 1w
- Light intensity 65,000 lux (approx.) at 1000mm
- Light field 170mm diameter at 1000mm
- Colour temperature 4000kelvin
- Colour rendering index 94
- Bulb life Approx 30,000 hours
- Switch At lamp head
- Working radius Approx 950mm
- Electrical input 120/240V 50-60Hz
- Total weight 18kg
- Mounting pin dia 18mm

Mobile Stand

- Stand height 1070mm
- Castor base Steel, white coated
- Base diameter 635mm approx.
- Castors 5 with 2 lockable and antistatic

Ceiling Mounted Series 5 OSRAM-LED Lamp

- Swivel radius 1750mm
- Room height 2500mm
- Total weight 19kg

Wall mounted Series 5 OSRAM-LED Lamp

- Swivel radius 1750mm
- Total weight 15kg



L540066A



L525067A



L511120A

Rated as measuring 99 Colour Rendering Index for R9 (saturated red) and R13 (skin colour) avoiding falsification of colours



L511120A 50w Provita Series 5 mobile lamp	£2575.00
L525067A 50w Provita Series 5 ceiling mounted lamp	£2575.00
L540066A 50w Provita Series 5 wall mounted lamp	£2575.00
SU400 Wall mount for code L540066A	£31.95
SU300 Rail mount	£43.30

Your local medical supplier is just a phone call away. See cover for full details

Prices shown are exclusive of VAT and delivery

When you buy Provita, you buy **quality**, **performance** and **reliability** at realistic prices.



Provita has an outstanding reputation for supplying quality 'made in Germany' for over 50 years. Whether as a mobile lamp, ceiling lamp, rail or wall lamp the Provita range provides the very best in quality, design and construction. The 6 series of lamps are designed to provide the very best illumination for all intended uses and to surpass all relevant safety regulations.



Series 1 LED Lamps with Flexible Arm and optional Halogen

- Hygienically covered gooseneck
- Double-housing cool lamphead
- Strong and stable metal handle
- Fine threaded joint lever
- Filter lens available for halogen (3,700k)

Technical details

- Lamp colour: White
- Bulb type: LED: with reflector
Halogen with cool light reflector
- Bulb: LED: 3x 1w
Halogen: 12v/50w with 10% divergence
- Light intensity: LED: 22,500 lux at 500mm
Halogen: 40,000 lux (approx) at 500mm
- Light field: LED: 100mm at 500mm
Halogen: 90/180mm diameter at 500mm and 1000mm respectively
- Colour temperature: LED: 4700kelvin
Halogen: 3000kelvin
- Bulb life: LED: 20,000 hours
Halogen: Approx 3000hrs continual burn time
- Switch: At lamp head
- Working radius: Approx 800mm
- Electrical input: 230/240v 50-60Hz
- Total weight: Approx 2.6kg lamp only
- Mounting pin dia.: 18mm



Dimmer for Series 1 and 2 lamps except wall lamp. See page 153



See page 153 for rail mount options and accessories.



Mobile Stand

- Stand height: 1070mm
- Caster base: Steel, white coated
- Base diameter: 635mm approx
- Castors: 5 with 2 lockable and antistatic

Series 1 LED Lamp with Flexible Arm

L100011A	LED lamp with flexible arm	£529.45
L100 005A	50w Provita halogen lamp on flexible arm	£357.35
SU400	Wall Mount	£31.95
SU300	Rail Mount	£43.30
SU550	Fixed height mobile stand	£112.30



Your local medical supplier is just a phone call away. See cover for full details

Prices shown are exclusive of VAT and delivery

Lighting Examination Lamps



Made in
GERMANY



LED provides 20,000 hours life. 6 x that of the conventional Halogen bulb.

Series 1 LED Lamps with Single Rigid Arm and optional Halogen

- Double-housing cool lamphead
- Strong and stable metal handle
- Fine threaded joint lever
- Filter lens available for halogen (3,700k)

Technical details

- Lamp colour White
- Bulb type LED: with reflector
Halogen with cool light reflector
- Bulb LED: 3x 1w
Halogen: 12v/50w with 10% divergence
- Light intensity LED: 28,500 lux at 500mm
Halogen: 48,000 lux (approx) at 500mm
- Light field LED: 100mm at 500mm
Halogen: 90/180mm diameter at 500mm and 1000mm respectively
- Colour temperature LED: 4700kelvin
Halogen: 3000kelvin
- Bulb life LED: 20,000 hours
Halogen: Approx 3000hrs continual burn time
- Switch At lamp head
- Working radius Approx 800mm
- Electrical input 230/240v 50-60Hz
- Total weight Approx 2.8kg lamp only
- Mounting pin dia. 18mm



Mobile Stand

- Stand height 1070mm
- Caster base Steel, white coated
- Base diameter 635mm approx
- Castors 5 with 2 lockable and antistatic

Series 1 LED Lamp with Single Rigid Arm

L100024A LED lamp with single rigid arm **£571.65**

L100 020A **£368.75**
50w Provita halogen lamp on Rigid Arm

SU400 Wall Mount **£31.95**

SU300 Rail Mount **£43.30**

SU550 Fixed height mobile stand **£112.30**



The *new* LED light bulb and specially developed reflector provide a well-focused illumination



See page 153 for rail mount options and accessories.

Your local medical supplier is just a phone call away. See cover for full details

Prices shown are exclusive of VAT and delivery



Series 1 LED Lamps with Double Joint Rigid Arm and optional Halogen

- Double-housing cool lamphead
- Strong and stable metal handle
- Fine threaded joint lever
- Filter lens available for halogen (3,700k)
- Also available with spring loaded arm system, details available on request

Technical details

- Lamp colour White
- Bulb type LED: with reflector
Halogen with cool light reflector
- Bulb LED: 3x 1w
Halogen: 12v/50w with 10% divergence
- Light intensity LED: 28,500 lux at 500mm
Halogen: 48,000 lux (approx) at 500mm
- Light field LED: 100mm at 500mm
Halogen: 90/180mm diameter at 500mm and 1000mm respectively
- Colour temperature LED: 4700kelvin
Halogen: 3000kelvin
- Bulb life LED: 20,000 hours
Halogen: Approx 3000hrs continual burn time
- Switch At lamp head
- Working radius Approx 1100mm
- Electrical input 230/240v 50-60Hz
- Total weight Approx 2.9kg lamp only
- Mounting pin dia. 18mm

Mobile Stand

- Stand height 1070mm
- Caster base Steel, white coated
- Base diameter 635mm approx
- Castors 5 with 2 lockable and antistatic

Series 1 LED Lamp with Double Joint Rigid Arm

L100071A	LED lamp with double jointed arm	£645.85
L100 061A	50w Provita Halogen lamp on Double Joint Rigid Arm	£442.90
SU400	Wall Mount	£31.95
SU300	Rail Mount	£43.30
SU550	Fixed height mobile stand	£112.30



See page 153 for rail mount options and accessories.

Your local medical supplier is just a phone call away. See cover for full details

Prices shown are exclusive of VAT and delivery

Lighting Examination Lamps

Series 1 Twinlight Lamp

A true multipurpose lamp with the ability to switch between the general purpose 20w bulb and the high intensity 50w examination bulb.



144

Technical details

- Lamp colour White
- Bulb type Double halogen bulbs with cool light reflector
- Bulb 12v/50w with 10% divergence
- Light intensity 48,000 lux (approx) at 500mm
- Light field 90/180mm diameter at 500mm and 1000mm respectively
- Colour temperature 3000kelvin
- Bulb life Approx 3000hrs continual burn time
- Switch At lamp head
- Working radius Approx 800mm to 1100mm depending on arm specified
- Electrical input 230/240v 50-60Hz
- Total weight Approx 3.6kg lamp only
- Mounting pin dia. 18mm

Mobile Stand

- Stand height 1070mm
- Caster base Steel, white coated
- Base diameter 635mm approx
- Castors 5 with 2 lockable and antistatic



L100 006A	50w/20w Provita lamp on flexible arm	£375.95
L100 019A	50w/20w Provita lamp on single joint arm	£417.15
L100 064A	50w/20w Provita lamp on double joint arm	£489.25
SU400	Wall Mount	£31.95
SU300	Rail Mount	£43.30
SU550	Fixed height mobile stand	£112.30

Your local medical supplier is just a phone call away. See cover for full details

Prices shown are exclusive of VAT and delivery



L125 067A
L127 067A
L130 067A

Series 1 LED Ceiling, Wall Lamps and optional halogen

The space saving alternative to the traditional wall and floor mounted lamp. Easy to manoeuvre and light in weight ensuring that this lamp is suitable for nearly all ceiling types.

- Single hand operated ceiling stem

Technical details

- Lamp colour White
- Bulb type LED with central reflector
Halogen with cool light reflector
- Bulb LED 12W
Halogen 35W with 10% divergence
- Light intensity LED 50,000 lux at 500mm
Halogen 40,000 lux at 500mm
- Light field 90/180mm diameter at 500mm and 1000mm respectively
- Colour temperature LED 4300 kelvin
Halogen 3000 kelvin
- Bulb life LED 30,000 hours
Halogen 3000 hours
- Switch At lamp head
- Working radius Approx 1100mm
- Electrical input 230/240v 50-60Hz
- Total weight Approx 4.9kg - for room height 2.5m
Approx 5.4kg - for room height 2.7m
Approx 5.9kg - for room height 3.0m
- Angle of rotation LED 370°
- Length of ceiling stem 500mm for room height 2.5m
700mm for room height 2.7m
1000mm for room height 3.0m

Series 1 Ceiling Mounted Lamps - Halogen

L125 067A	50W Provita Halogen lamp for ceiling height up to 2.5m	£707.65
L127 067A	50W Provita Halogen lamp for ceiling height up to 2.7m	£736.45
L130 067A	50W Provita Halogen lamp for ceiling height up to 3.0m	£775.60

Series 1 Ceiling Mounted Lamps - LED

L125 080A	12W Provita LED lamp for ceiling height 2.5m	£907.65
L127 080A	12W Provita LED lamp for ceiling height 2.7m	£936.45
L130 080A	12W Provita LED lamp for ceiling height 3.0m	£975.60



L140 080A
L140 066A

Series 1 LED Wall Mounted Lamp

L140 080A	50W Provita LED lamp with dedicated wall mounting plate	£751.10
L140 066A	50W Provita Halogen lamp with dedicated wall mounting plate	£592.25

Your local medical supplier is just a phone call away. See cover for full details

Prices shown are exclusive of VAT and delivery

Lighting Examination Lamps



Series 2 LED Minor Examination Lamps with optional Halogen

Technical details

- Lamp colour White
- Bulb type LED: with reflector
Halogen with cool light reflector
- Bulb LED: 8050 lux at 500mm
Halogen: 12v/20w with 10% divergence
Light intensity 17,500 lux (approx) at 500mm
- Light field LED: 430mm at 500mm
Halogen: 90/180mm diameter at 500mm and 1000mm respectively
- Colour temperature LED: 5300kelvin
Halogen: 3000kelvin
- Bulb life LED: 30,000hrs
Halogen: Approx 3000hrs continual burn time
- Switch At lamp head
- Working radius Approx 800mm flexible arm
- Electrical input 230/240v 50-60Hz
- Total weight Approx 3.2kg lamp only
- Mounting pin dia. 18mm

Mobile Stand

- Stand height 1070mm
- Caster base Steel, white coated
- Base diameter 635mm approx
- Castors 5 with 2 lockable and antistatic

Made in
GERMANY



Dimmer for Series 1 and 2 lamps except wall lamp. See 153



See page 153 for rail mount options and accessories.

L220 216A	20w Provita LED lamp on flexible arm	£465.75
L220 212A	20w Provita Halogen lamp on flexible arm	£265.75
SU400	Wall Mount	£31.95
SU300	Rail Mount	£43.30
SU550	Fixed height mobile stand	£112.30



Your local medical supplier is just a phone call away. See cover for full details

Prices shown are exclusive of VAT and delivery



Series 2 LED Minor Examination Lamps with optional halogen

Technical details

- Lamp colour White
- Bulb type LED: with reflector
Halogen with cool light reflector
- Bulb LED: 8050 lux at 500mm
Halogen: 12v/20w with 10% divergence
Light intensity 17,500 lux (approx) at 500mm
- Light field 430mm at 500mm
Halogen: 90/180mm diameter at 500mm and 1000mm respectively
- Colour temperature LED: 5500kelvin
Halogen: 3000kelvin
- Bulb life LED: 30,000hrs
Halogen: Approx 3000hrs continual burn time
- Switch At lamp head
- Working radius Approx 1100mm double joint arm
- Electrical input 230/240v 50-60Hz
- Total weight Approx 3.2kg lamp only
- Mounting pin dia. 18mm

Mobile Stand

- Stand height 1070mm
- Caster base Steel, white coated
- Base diameter 635mm approx
- Castors 5 with 2 lockable and antistatic



See page 153 for rail mount options and accessories.



Dimmer for Series 1 and 2 lamps except wall lamp. See 153

Series 2 Minor Examination Lamp with double joint arm

L210 216A	20w Provita LED lamp on single joint arm	£519.70
L210 212A	20w Provita Halogen lamp on single joint arm	£319.70
SU400	Wall Mount	£31.95
SU300	Rail Mount	£43.30
SU550	Fixed height mobile stand	£112.30



Your local medical supplier is just a phone call away. See cover for full details

Prices shown are exclusive of VAT and delivery

Lighting Examination Lamps



Made in
GERMANY



Dimmer for Series 1
and 2 lamps except
wall lamp. See 153

Series 2 Lamp with flexible arm

Technical details

- Lamp colour White
- Bulb type Halogen with cool light reflector
- Bulb 12v/20w with 36°
Light intensity 2.100 lux (approx) at 500mm
- Light field 440/880mm diameter at 500mm and
1000mm respectively
- Bulb life Approx 3000hrs continual burn time
- Switch At lamp head or switch cord
- Working radius Approx 800mm
- Electrical input 230/240v 50-60Hz
- Total weight Approx 2.6kg lamp only
- Mounting pin dia. 18mm

Mobile Stand

- Stand height 1070mm
- Caster base Steel, white coated
- Base diameter 635mm approx
- Castors 5 with 2 lockable and antistatic



See page 153 for
rail mount options
and accessories.

Series 2 Reading Lamp with flexible arm

L230 112A		£213.15
20w Provita lamp on flexible arm		
SU400	Wall Mount	£31.95
SU300	Rail Mount	£43.30
SU550	Fixed height mobile stand	£112.30



Your local medical supplier is just a phone call away. See cover for full details

Prices shown are exclusive of VAT and delivery



Series 3 LED Lamps with flexible arm and optional energy-saving Fluorescent

Technical details

- Lamp colour White
- Bulb type LED with reflector
Energy saving fluorescent
- Bulb 3w LED
Fluorescent: 11w electronic
- Colour temperature 5500kelvin LED
Fluorescent: 6500kelvin (daylight)
- Bulb life Approx 25,000hrs continual burnt time LED
Fluorescent: Approx 20,000hrs continual burnt time
- Switch At lamp head
- Working radius Approx 600mm
- Electrical input 230/240v 50-60Hz
- Total weight Approx 1.25kg lamp only
- Mounting pin dia. 18mm

Mobile Stand

- Stand height 1070mm
- Caster base Steel, white coated
- Base diameter 635mm approx
- Castors 5 with 2 lockable and antistatic

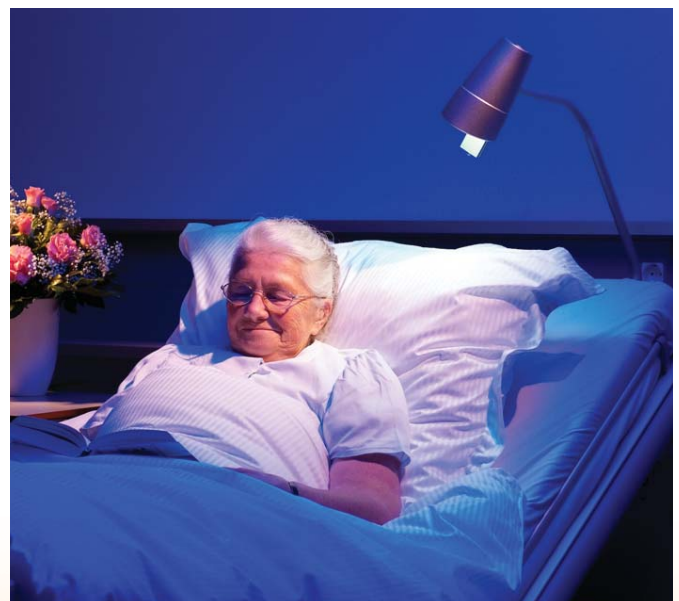

L320 214A		£445.05
3w Provita LED lamp on flexible arm with switch cord		
L320 114A		£309.65
3w Provita LED lamp on flexible arm		
L320 212A		£345.05
11w Fluorescent Provita lamp on flexible arm with switch cord		
L320 112A		£209.65
11w Fluorescent Provita lamp on flexible arm		
SU400	Wall Mount	£31.95
SU300	Rail Mount	£43.30
SU550	Fixed height mobile stand	£112.30

Your local medical supplier is just a phone call away. See cover for full details

Prices shown are exclusive of VAT and delivery

Lighting Bed Head Lamps



L400 025S Short version in silver



L400 035S Long version in silver

L400 025A Short version in white



Series 4 LED Lamps with flexible arm and optional Halogen

Technical details

- Lamp colour White or silver
- Bulb type LED: with reflector
Halogen with cool light reflector
- Bulb LED:12v/3w
Halogen:12v/10w with 38 degree divergence
- Bulb life LED: Approx 40,000hrs continual burn time
Halogen: Approx 2000hrs continual burn time
- Switch At lamp head
- Working radius Approx 600mm
- Electrical input 230/240v 50-60Hz
- Total weight Approx 2.0kg lamp only

Mobile Stand

- Stand height 1070mm
- Caster base Steel, white coated
- Base diameter 635mm approx
- Castors 5 with 2 lockable and antistatic

L400 069A	£257.30
3w Provita LED lamp in white, short version	
L400 025A	£185.25
10w Provita Halogen lamp in white, short version	
L400 069S	£282.25
3w Provita LED lamp in silver, short version	
L400 025S	£210.25
10w Provita Halogen lamp in silver, short version	
L400 079A	£280.80
3w Provita LED lamp in white, long version	
L400 035A	£208.75
10w Provita Halogen lamp in white, long version	
L400 079S	£310.20
3w Provita LED lamp in silver, long version	
L400 035S	£238.15
10w Provita Halogen lamp in silver, long version	

SU400	Wall Mount	£31.95
SU300	Rail Mount	£43.30
SU550	Fixed height mobile stand	£112.30

Your local medical supplier is just a phone call away. See cover for full details

Prices shown are exclusive of VAT and delivery



Series 6 stylish reading lamp with High-Grade LED and Spread Optics

- Dispersive optic and colour rendering
- Switch controls the LED with a “delayed powering-on”
- Integrated night orientation light (green) in the switch is protected by secured glass
- Practical handle is incorporated in the light head
- Lamp head manufactured from high-gloss polished stainless steel guaranteeing long life and offering hygienic cleansing
- Extremely flexible, transparent shrinking cover lamp arm ensures high abrasion resistance and good isolation properties
- Can be cleaned with disinfectant
- Total power consumption of the mercury-free LED is only 1,8 Watt
- Light bulb is shock- and vibration proof
- Optimized thermo-management guarantees the long life of the light bulb and minimizes the maintenance costs

Made in GERMANY

Technical details

- Colour of lamp: Silver or white
- Bulb type: LED
- Bulb details: 5V / 1.8 W / 170°
- Light intensity: approx. 1.320 Lux / 500 mm
- Light field: approx. 500 mm at 500mm distance
- Colour temperature: 6.500 Kelvin
- Life time: approx. 50.000+ hours
- Main power: 100-240 VAC, 50-60 Hz
- Spigot: 18 x 35 mm
- Total weight: approx. 0.9 kg

10 YEAR LED Warranty

Green LED technology

L600035S	£289.00
Series 6 Lamp – Flexible Arm, Silver, Long version 1484mm length	
L600025S	£289.00
Series 6 Lamp – Flexible Arm, Silver, Short version 1064mm length	
L600035A	£289.00
Series 6 Lamp – Flexible Arm, White, Long version 1484mm length	
L600025A	£289.00
Series 6 Lamp – Flexible Arm, White, Short version 1064mm length	
L610035A	£289.00
Series 6 Lamp – Gooseneck Arm, White, Long version 1484mm length	
L610025A	£289.00
Series 6 Lamp – Gooseneck Arm, White, Short version 1064mm length	

Your local medical supplier is just a phone call away. See cover for full details

Prices shown are exclusive of VAT and delivery

Lighting Examination Lamps

Children's Rainbow Mobile Lamp

Colourful mobile lamp that can brighten up any environment with its rainbow format

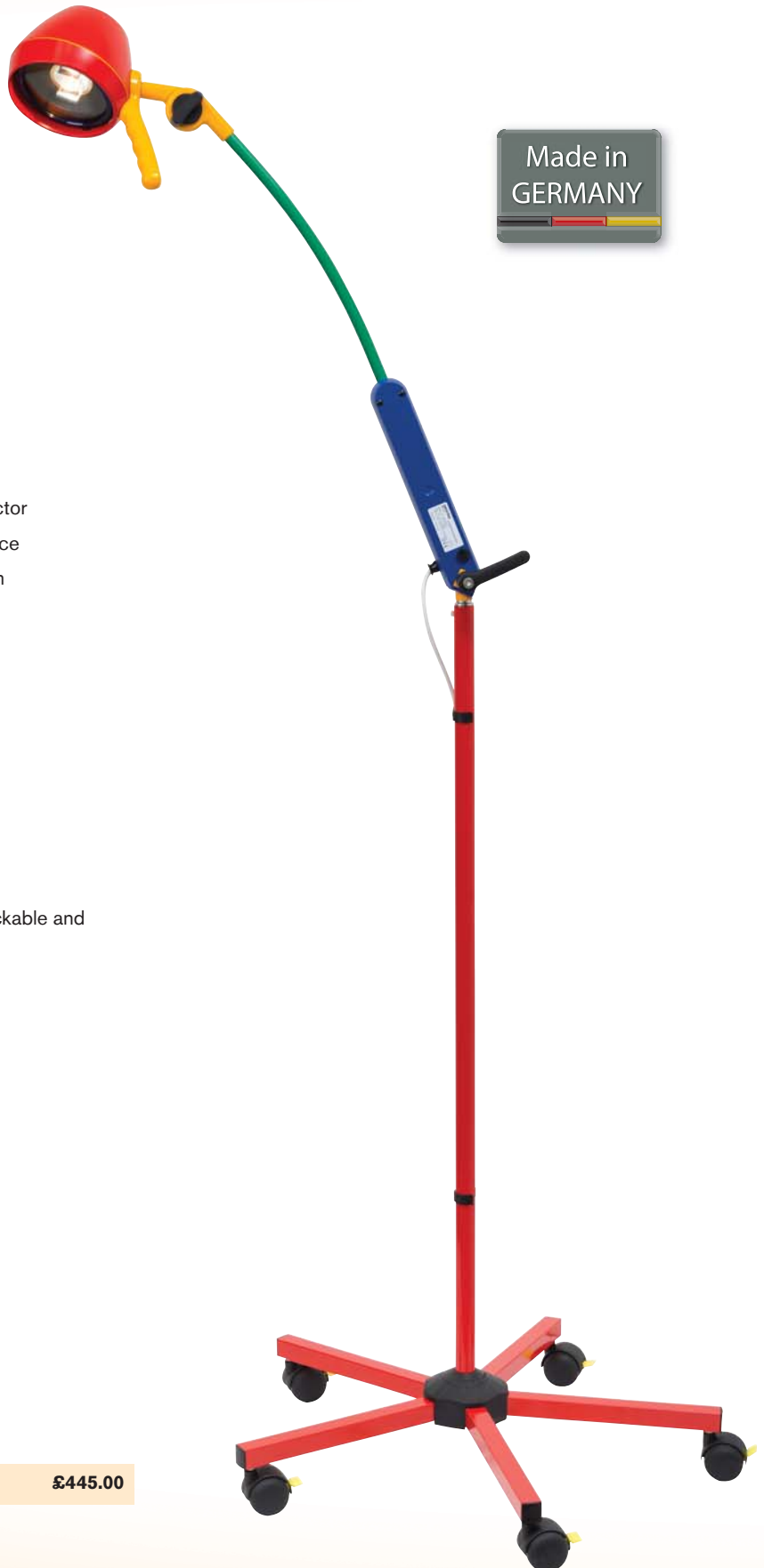

Lamp colour:	Red, yellow, green and blue
Bulb type:	Halogen with cool light reflector
Bulb:	12v/35w with 10% divergence
Light intensity:	40,000 lux (approx.) at 500m
Colour temperature:	3000kelvin
Bulb life:	Approx. 3,000 hours continual burn time
Switch:	At lamp head
Working radius:	Approx. 800mm
Electrical input:	230/240v 50-60Hz
Total weight:	Approx 7.8kg
Mounting pin dia:	18mm
Stand height:	1070mm
Castors:	5 x 50mm twin castors, 2 lockable and antistatic
Base dia.:	635mm

L111120K

£445.00

Your local medical supplier is just a phone call away. See cover for full details

Prices shown are exclusive of VAT and delivery



Z2N6 6092



Z2KO 679A

Accessories

Z2KO 679A Ceiling cover	£102.00
Z2NO 647W Wall rail clamp for rails from 25mm x 10mm and 30 x 10mm	£39.15
Z2NO 617A Wall mount 60x60x70mm with 4 holes	£37.10
K2N5 224 Colour correction filter to 3800+/- 200K only available for halogen	£91.70
Z2N6 6092 Dimmer for Series 1 and 2 lamps except wall lamp	£51.50
Z2N6 6192 Dimmer for Series 1 wall lamp	£51.50
Z2NO 502A Tubing clamp mount powder coated white for tubes from 25 -50mm diameter	£33.00
S000 803A Stand with caster base, white powder coated, 1070mm high	£112.30
S011 820A Stand with caster base, with height adjustment, white powder coated	£131.85



Provita Rail Mount System for Examination Lights

- 'Head to Toe' working area
- The light rail can be wall mounted alongside the examination couch, giving a much 'wider' working area than a standard wall mount
- Just loosen the rail clamp and slide your examination light to the desired working position
- Intense light is achievable regardless of the site of examination/operation
- The rail is easy to install and available in a variety of lengths to suit your requirements
- Can be used in conjunction with any Provita examination/minor ops light (Light not included)
- Rail includes brackets, fixings and rail clamp

Mountings available

SU350-50	Rail mount system, 50cm long incl. clamp	£159.00
SU350-100	Rail mount system, 100cm long incl. clamp	£189.00
SU350-150	Rail mount system, 150cm long incl. clamp	£229.00
SU350-200	Rail mount system, 200cm long incl. clamp	£249.00

35w L210212A shown mounted on a 50cm rail



Your local medical supplier is just a phone call away. See cover for full details

Prices shown are exclusive of VAT and delivery

Lighting Magnifying Lamps



Daylight Diagnostic Magnifying Lamp

- Diagnostic magnifying lamp suitable for clinical examination procedures
- Classic mag-lamp design with round 22watt daylight fluorescent tube surrounding magnifying lens
- Interchangeable magnifying lenses, supplied with 1.75x and 2.2x magnification
- Low heat output
- Spring action arm system, holds working position well
- Internal 240v mains transformer
- Available in wall, desk or heavy duty base versions

D22030-01 £149.99
Daylight Diagnostic Slimline Magnifying Lamp – desk mounted

D90578 £23.99
Wall bracket for Daylight Diagnostic Magnifying Lamp

D53060 £134.99
Five spoke floor stand for Daylight Diagnostic Magnifying Lamp

Daylight Ultra Slim Fluorescent Magnifying Lamp

- Most advanced, low heat magnifying lamp with a fantastic large lens and a high light-output
- Unique slim design
- Lens: 17.5cm diameter, 1.75 x magnification
- 28watt daylight tube
- Electric Ballast



D22080 £239.99
Daylight Ultra Slim Magnifying Lamp – desk mounted

D90578 £23.99
Wall bracket for Daylight Ultra Slim Magnifying Lamp

D53060 £134.99
Five spoke floor stand for Daylight Ultra Slim Magnifying Lamp

Extra Lenses

D62001 £34.99
Ultra Slim optional XR lens (for D22080) (5 diopter Replacement lens)

D62002 £34.99
Ultra Slim swing arm XR lens (for D22080) (12d, 15d with lamp)

D62091 £39.99
ESD optional lens (for D22091) (5 diopter Replacement lens)

D63001 £34.99
Deluxe optional XR lens (for D23080) (5d, 8d with lamp)

D63002 £34.99
Deluxe swing arm XR lens (for D23080) (12d, 15d with lamp)

Your local medical supplier is just a phone call away. See cover for full details

Prices shown are exclusive of VAT and delivery

Deluxe Magnifying Light

- Wide Field Magnifying Lamp – ideal for close-up inspection work
- Deluxe Head and Lens – with twin 13watt low-energy bulbs for optimum light control
- 19 x 17.5cm Glass Lens – provides 1.75x (3 diopter) magnification
- Increased Magnification – when using optional lenses
- Optimal Flexibility and Durability – from redesigned arm system
- Electronic Ballast – flicker-free illumination
- Available in Desk, Wall and Mobile Versions
- Length of Arm 95cm



D23080



D23080 + D63001



D63002

D23080	Deluxe Magnifying Lamp – desk mounted	£269.99
D90578	Wall bracket for Deluxe Magnifying Lamp	£23.99
D53060	Five spoke floor stand for Deluxe Magnifying Lamp	£134.99

Options and Accessories:

D13625	13 watt low-energy bulb	£16.99
D63001	5 Diopter Lens	£34.99
D63002	12 Diopter Lens	£34.99



D63001

Your local medical supplier is just a phone call away. See cover for full details

Prices shown are exclusive of VAT and delivery

Furniture Couches

Why choose a **Select** couch

In today's cost conscious environment there is a lot of pressure to purchase the cheapest couch available. The Select range enables you to purchase a first class quality engineered couch at very reasonable cost and with features that few other couches can provide at the same price if at all.

Compare these standard Select features to see how your intended purchase fares:



2 Ease of Use

The elevated upholstery section provides the elderly with the ability to grasp the couch sides much more easily than flush mounted upholstery. A small, but crucial point for the less mobile.

1 Safety

All Select static couches comply with DIN31 001. This relates to the SAFE FINGER TRAP SPACE which must be provided underneath the upholstery and is especially relevant under the elevating head section. With the vast majority of couches there is NO safe finger trap space provided. The consequences of a head rest inadvertently slamming shut on an examiners fingers with the force of the upper body weight of the patient can only be imagined and would be a serious HEALTH and SAFETY issue. Where indicated the Select range of couches provides a safe space between the frame and the elevating head rest.

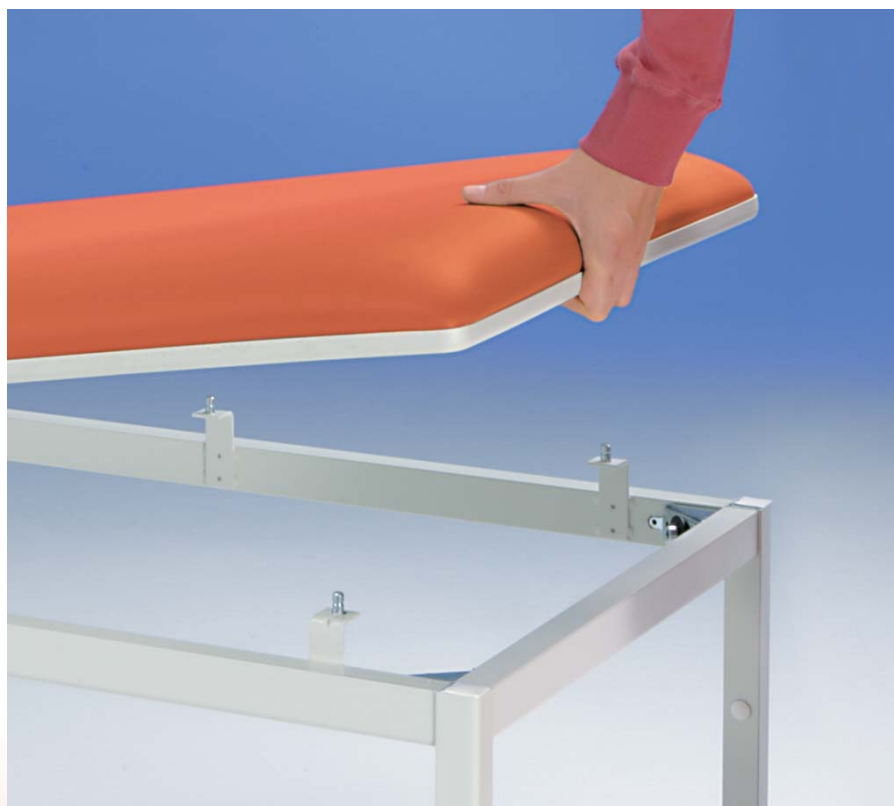

Your local medical supplier is just a phone call away. See cover for full details

Prices shown are exclusive of VAT and delivery



3 Stability

Each Select couch has been assessed for its stability and only models which provide extreme stability are incorporated into the range.

4 Hygiene

Where indicated the Select Static range utilises antibacterial leather.

5 Comfort

Even the basic couches are constructed with 55mm thick upholstery for comfort and the vast majority use 70mm thick fire resistant upholstery and are especially comfortable for the elderly. The choice of these materials ensures rapid reshaping and a crease free cover.

6 Simple to construct

Generally speaking only eight steel screws are required and construction is simple and straightforward. Jack screws allow compensation for uneven floors.



7 Durability

Every Select couch has been chosen for the quality of its construction and overall durability. 400kg placed on the couches results in NO defects or deformation. Ratchets have been tested for over 10,000 working cycles with NO wear appearing. In the event that the upholstery on the Examiner range is cut or torn a new top can be fitted WITHOUT tools, which is much more cost effective than replacing the couch. Fancy a colour change? Simply replace couch tops with the colour of your choice.

8 Accessories

A wide range of useful accessories are available either factory fitted or user fittable such as; gynaecology leg rests, handles, basin cut outs, side rails, drip arms, arm rests, cot sides, castors etc.



9 Warranty

So proud are we of the Select range that on indicated models we are pleased to offer a 5 year warranty against any defects in manufacture.



Your local medical supplier is just a phone call away. See cover for full details

Prices shown are exclusive of VAT and delivery

2 Section Couches



Excellent Value for Money

Select Attendant 2 Section Couch

- Ideal for use in Occupational health or satellite surgeries
- 195 long x 65cm wide x 65cm high with 55mm deep upholstery
- Head rest adjustment with single central ratchet
- Legs with self levelling jack screws for uneven surfaces
- Couch roll holder
- Load capacity 400kg static weight
- Load capacity 135kg dynamic weight
- Excellent value for money
- Quick self assembly using only 8 steel screws
- Upholstery distance complies with DIN3100

Colours available

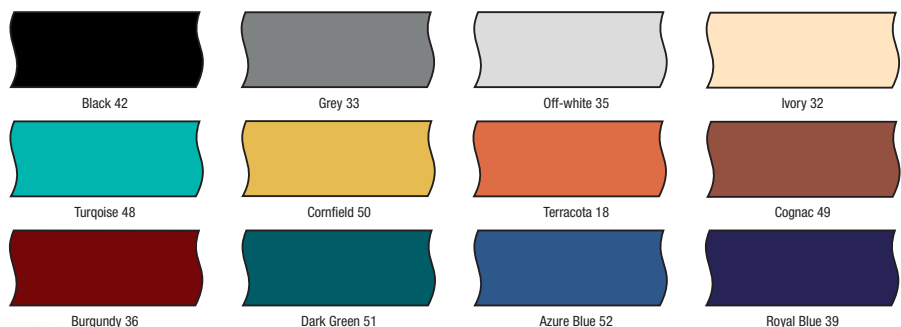

AWS-60672.6123.(Colour Code) Select Attendant standard couch **£289.30**

Your local medical supplier is just a phone call away. See cover for full details
 Prices shown are exclusive of VAT and delivery

2 Section Couch



Shown with optional chrome finish

Superb quality from only £323.80

Select Examiner 2 section Surgery Couch

- 195 long x 65cm wide x 65cm high with 70mm deep fire resistant upholstery
- Antibacterial high quality imitation leather
- Powder coated frame
- Head rest adjustment +34 degrees
- 2 galvanised head rest ratchets provide sturdy and safe elevation
- Legs with self levelling jack screws for uneven surfaces
- Couch roll holder
- Load capacity 400kg static weight
- Load capacity 135kg dynamic weight
- Excellent value for money
- Quick self assembly using only 8 steel screws
- Upholstery distance complies with DIN3100
- Upholstery replaceable without tools!

AWS-60666.6123 (Colour Code) £323.80
Select Examiner surgery couch



Also available in a short format for restrooms and other restricted space areas

- 175cm x 65cm x 65cm high

AWS-60642.6123 (Colour Code) £352.30
Select Examiner Mini surgery couch short version

Examina Classic Couch

- Chrome finish with towel rail holder (please specify colour)
- Also available in Bariatric version capable of 600kg static load or 200kg moving load

AWS-60666.6133.6123 (Colour) £461.90
Examiner Classic couch Chrome finish

Colours available



Your local medical supplier is just a phone call away. See cover for full details

Prices shown are exclusive of VAT and delivery

Furniture Couches

Select Alpha 2 Section Examination Couch

- Economically priced yet sturdy and robust examination couch
- Synthetic leather upholstery is strong, durable and easy to clean
- Framework constructed from epoxy coated steel tubing
- Articulated headrest
- Towel rail included
- Dimensions: 1900 x 600 x 700mm
- Blue or black upholstery



AWS-H0303A3

Select Alpha Examination Couch in blue or black

£289.30



Your local medical supplier is just a phone call away. See cover for full details

Prices shown are exclusive of VAT and delivery

Select Alternative Fold Away Examination Couch



Stool not included

195 x 65 x 68cm high fold away examination couch. Legs fold using pneumatic spring mechanism with 2 adjustable ratchets at each end of the couch. Wall drilling template provided. 2 Head parts mean you can choose on which side of the patient you wish to work. Supplied with antibacterial imitation leather.

- 70mm thick upholstery
- Upholstery distance complies with DIN3100
- 2 ratchet mechanisms at each end provide stable head rest elevation
- When folded the couch projects only 16cm into the room
- 135kg dynamic weight and 400kg static weight

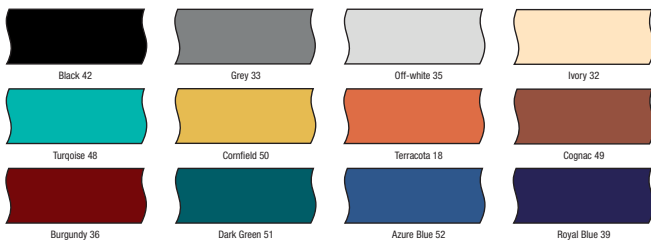

Projects only 16cm into room when folded



Adjustable ratchet mechanisms at either end



Pneumatic spring mechanism on legs

Unique and Versatile

68692.68

Select Alternative Folding Couch (state colour required)

£563.40

Your local medical supplier is just a phone call away. See cover for full details

Prices shown are exclusive of VAT and delivery

Furniture Couches

Plinth 502 2 section couch

- Robust – ideal for use in Outpatients, GP surgeries and other establishments where continuous use is required
- Easy operation
- Hoist accessible
- High density fire retardant foam
- Anti microbial vinyl
- Max weight 225Kg
- Gas strut backrest mechanism
- Adjustable feet
- Retractable castors
- Paper roll holder optional (please specify at time of ordering)
- Choice of electric or hydraulic
- Length 188cm
- Width 63cm
- Height 46cm to 95cm
- Weight 82Kgs packed
- 3 year warranty excluding upholstery

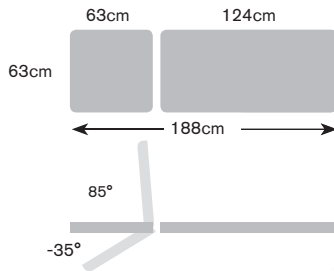

P502E	Plinth 502 Electric couch	£750.00
P502H	Plinth 502 Hydraulic couch	£750.00
	Carriage	£85.00

Plinth 503 3 Section Couch

- Firm and stable providing ideal base for general treatment techniques
- Easy operation
- Hoist accessible
- High density fire retardant foam
- Anti microbial vinyl
- Max weight 225Kg
- Gas strut backrest mechanism for backrest and footrest
- -35 to +85° movement range
- Adjustable feet
- Retractable castors
- Paper roll holder optional (please specify at time of ordering)
- Choice of electric or hydraulic
- Length 185cm
- Width 63cm
- Height 46cm to 95cm
- Weight 82Kgs packed
- 3 year warranty excluding upholstery

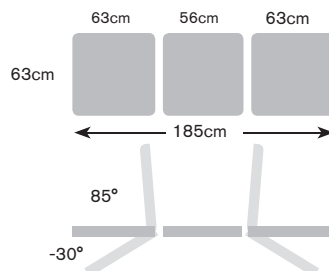

P503E	Plinth 503 Electric couch	£800.00
P503H	Plinth 503 Hydraulic couch	£800.00
	Carriage	£85.00

Plinth 502 and 503 Options

COTS	Cot Sides	£122.50
EWH	Extra width upholstery 74cm	£60.00
DTU	Double thickness upholstery	£60.00
FSW	Foot switch (electric models only)	£49.00

Please choose your options from the following list:

PRH	Plinth towel roll holder	£31.25
BS	Plinth breathing hole and plug	£31.25
MB	Motorised backrest (electric models only)	£289.00

Your local medical supplier is just a phone call away. See cover for full details

Prices shown are exclusive of VAT and delivery

H-205 2 Section Electric Examination Couch

- Head rest adjustment with ratchet mechanism
- Adjustable height: 650 – 890mm
- Imitation, leather upholstery
- Height adjustable levelling feet
- 1900mm length x 600mm wide
- Load capacity 400kg static weight
- Load capacity 135kg dynamic weight
- Supplied assembled
- Colours: black, blue, grey, beige, white. Please specify when ordering
- Grey enamelled steel frame



AWS-H20503

H-205 2 section electric couch

£699.00

Carriage **£40.00**

Gynaecology Couches

As one of the most common areas of examination the Select range of Gynaecology couches and tables have been chosen to provide the best working environment for both patient and practitioner.

Plinth 93PE – 3 section Gynaecology Couch

Traditional gynae design with tilting seat, ankle stirrups and tray allowing ideal patient comfort and positioning for gynae examinations.

This couch can also be used for general examination and with the addition of basic accessories can expand to become a competent operating and recover table.

- Easy operation
- Hoist clearance of 13cm
- High density fire retardant foam
- Anti microbial vinyl
- Max weight 225Kg
- Gas strut backrest mechanism
- Adjustable feet
- Retractable castors
- Paper roll holder optional (please specify at time of ordering)
- Choice of electric or hydraulic
- Length 189cm
- Width 63cm
- Height 46cm to 95cm
- Weight 82Kgs packed
- 3 year warranty excluding upholstery



93PE	Plinth 93PE Electric couch	£1200.00
	Carriage charge applies to both models	£85.00

Please choose your options from the following list:

PRH	Plinth towel roll holder	£31.25
BS	Plinth breathing hole and plug	£31.25
MB	Motorised backrest (electric models only)	£289.00
COTS	Cot Sides	£122.50
EWH	Extra width upholstery 74cm	£60.00
DTU	Double thickness upholstery	£60.00
FSW	Foot switch (electric models only)	£49.00
KT	Knee troughs - pair	£150.00

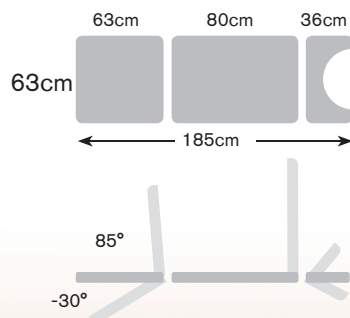

Your local medical supplier is just a phone call away. See cover for full details

Prices shown are exclusive of VAT and delivery

Furniture Treatment Chairs

Select Gynaecology Armchair

- Designed for gynaecology and urology examinations but may also be used as a flat table for minor ops
- Easy to clean high quality upholstery resistant to urine, blood and disinfectant products.
- Fire retardant and antibacterial
- Equipped with 3 motors for easy operation by staff
- Independently adjustable head and footrests
- Trendelenburg position
- Height adjustable from 55cm to 95cm
- Stainless steel waste tray under seat
- Anatomical leg rests included, adjustable for height and position
- Hand grips included
- 100mm dia castors with brakes
- Paper roll holder included



AWS-H301-03

Gynaecology and minor ops chair

£3399.00

AW Select Treatment Chair

- Synthetic leather cushioned upholstery
- Articulated head and leg section
- Head section reclines below the horizontal
- Integral head rest
- Twin individually adjustable arm rests
- Available in blue or black
- Dimensions 1650mm x 600mm x 1200mm
- Weight 31kg
- 150kg max user weight
- Epoxy finish

Colours Available



Black Blue



AWS-H720 Black Black AW Select Treatment Chair **£1014.00**

AWS-H720 Blue Blue AW Select Treatment Chair **£1014.00**

Your local medical supplier is just a phone call away. See cover for full details

Prices shown are exclusive of VAT and delivery

Patient Trolley Type 2

- High quality patient trolley with articulated and removable head rest
- Reinforced folding cot sides
- 150mm diameter castors, two with brakes, with bumpers
- Stainless steel or chrome framework
- Synthetic leather upholstery is easy to wash and sanitise and very durable
- Standard accessories included are:
 - Oxygen bottle holder
 - Infusion stand
 - Instrument tray
- Dimensions 2000 x 550 x 800mm
- Bed size: 1900 x 550mm



AWS-H3700

£1268.80

Select Patient Trolley Type 2 with stainless steel framework

Patient Trolley Type 1

- High quality patient trolley manufactured from durable steel
- Articulated headrest, reinforced folding cot sides
- 125mm diameter castors, two with brakes, with bumpers
- Standard accessories included are:
 - Oxygen bottle holder
 - Infusion stand
 - Instrument tray
- Synthetic leather upholstery is easy to wash and sanitise and very durable
- Dimensions 1900 x 600 x 850mm



AWS-H35

£796.80

Select Patient Trolley Type 1

Select Hydraulic patient trolley

- Hydraulic lifting mechanism from 75cm to 130cm
- Articulated headrest secured by mechanical ratchet
- Reinforced folding side rails
- Foot rail
- 15cm dia direction castors with brakes and bumper
- Oxygen bottle holder
- IV stand
- Oddments tray
- 190cm x 55cm table dimensions
- Enamelled steel construction



AWS-H33-000

£1920.00

Select Hydraulic Patient Trolley

Your local medical supplier is just a phone call away. See cover for full details

Prices shown are exclusive of VAT and delivery

Furniture Couch Accessories & Steps

Washable PVC Couch Cover

- Fitted PVC waterproof couch cover
- Elasticated edges fit most standard couches
- Protect your couch and your patient by reducing the risk of cross-contamination
- Hard-wearing woven PVC, clear white



AWF-310 PVC Couch Cover **£28.60**

Select Couch Roll Holder

- Stand alone couch roll holder
- Holds standard 20" couch rolls
- Metal construction with knock-resistant white epoxy finish
- Dimensions 970mm x 570mm x 310mm

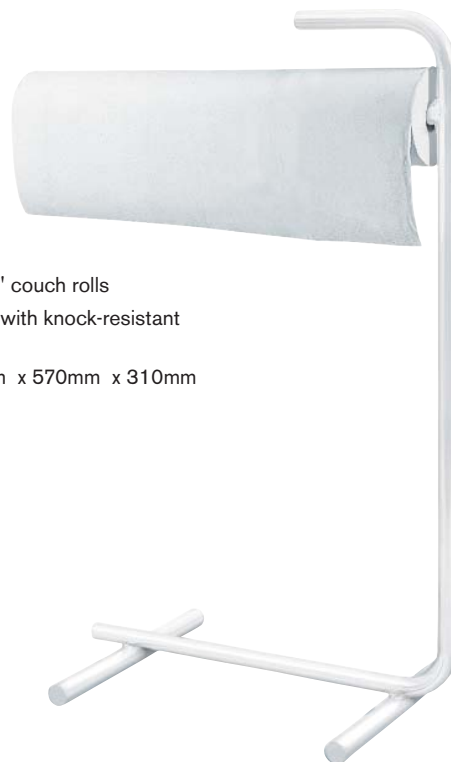

AWS-A4405 Select Couch Roll Holder **£70.40**



Select Raiza Couch Steps

- Crafted from hygienic integral foam top with non slip surface
- Tilt proof
- Complies with DIN4569 and Accident Prevention Guidelines VBG74
- Non slip anti-static feet.
- Available in 3 convenient stackable sizes
- Load capacity 200kgs, 31+ stone

AWS-42278	£120.40
Select Raiza mini couch step. 45x30cm platform. 12cm high. 4.0kg	
AWS-42282	£120.40
Select Raiza midi couch step. 45x30cm platform. 22cm high. 4.5kg	
AWS-42284	£133.70
Select Raiza maxi couch step. 45x30cm platform. 30cm high. 4.7kg	
AWS-Raiza 42278/82/84 Set of 3 steps	£355.30

Your local medical supplier is just a phone call away. See cover for full details
Prices shown are exclusive of VAT and delivery

AW Select Couch Steps

- Single and 2 tier couch steps
- Strong steel construction in epoxy resin finish with tough plastic top
- Stable and safe to use
- Rubber anti-slip surfaces

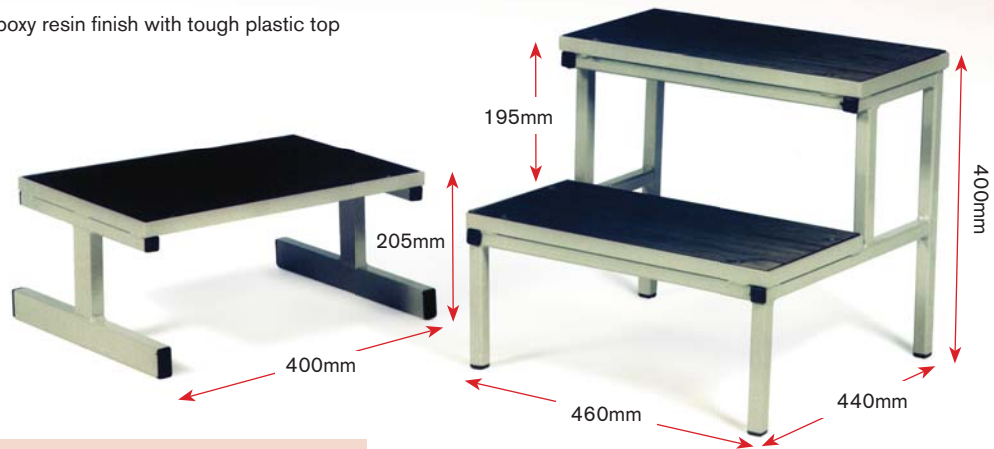

AWF200 Single tier couch step	£58.20
AWF210 Double tier couch step	£94.40

AW Select Couch Step

- Single Tier couch step
- Strong tubular steel construction
- Available in white only
- Rubber anti-slip surface



Height of step 21cm
Width of step 24cm
Length of step 37cm

AWF-225 AW Select non-tip Couch Step Single Tier	£58.20
---	---------------

AW Select Chrome Couch Steps

- Modern designed couch steps in a choice of single, double or triple tier versions
- High chrome finish with black composite plastic platforms
- Anti-slip surfaces
- Strength and stability is assured with top quality materials and craftsmanship
- 2 year warranty



AWS-430 AW Select Couch Step, single tier	£58.20
AWS-440 AW Select Couch Step, double tier	£93.90

Your local medical supplier is just a phone call away. See cover for full details
Prices shown are exclusive of VAT and delivery

Furniture Phlebotomy Chairs & Arm/Leg Rests

Select Eco Haemo Chair

- Easy to clean imitation leather upholstery
- 2 swivelling and height adjustable arm rests in black foam
- 135kg max load
- Seat height 49cm
- Seat dimensions 47cm wide x 47cm deep

For colours see page 176 numbered codes



AWS-40335 £258.90
Select Eco Haemo Chair

Select Haemo Plus

- Blood sampling chair for adipose patients
- With extra wide capacity due to cranked and swivelling arms
- Height adjustable arm rests
- Max 135kg weight

For colours see page 176 numbered codes



AWS-40331 £341.10
Haemo Plus Chair

Select Arm and Leg Support. Standard Model

- High quality all metal construction including 45cm dia. base
- Hygienic seamless upholstery of integral foam
- Rotatable and inclinable arm rest
- Height adjustable from 55 – 86cm
- Easy to assemble
- Adjustable feet for uneven floors



AWS-4278 £101.00
Select Arm and Leg Support

Select Arm and Leg Support. Plus Model

- Solid and massive construction.
- 45cm diameter base
- Jack screws to compensate for uneven floor
- Hygienic seamless upholstery of integral foam
- Rotating, inclinable and swivelling arm rest
- Height adjustable from 55 – 86cm
- Easy to assemble



AWS-4277 £171.40
Select Arm and Leg Support

AW Select Phlebotomy Chair

- Ideal for blood letting etc.
- Upholstered arm rest is removable and may be set in any position
- Dimensions 500mm x 400mm x 850mm
- Weight 9kg
- 120kg max user weight



Colours Available

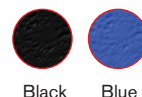

Black Blue

AWS-H680/Black	£383.70
Select Phlebotomy Chair, black	
AWS-H680/Blue	£383.70
Select Phlebotomy Chair, blue	
AWS-H680/Rest	£102.00
Additional Arm Rest	

AW Premier Arm and Leg Rest

- Superior quality arm and leg rest with height adjustment
- Chromium plated steel
- PU foam arm/leg pad which is height and tilt adjustable
- Adjustable range 680-880mm
- Pad size 300 x 100mm
- Base diameter 635mm



S 210 2037 £182.60
Adjustable arm/leg rest on static 5 bar castor

AW Select Arm & Foot Rest

- Ridged foam top with blue synthetic leather upholstery
- Rest is removable and orientable in all directions
- Adjustable height from 700 - 1150 mm
- Suitable as a foot rest when patient is sat on examination couch
- Five point fixed base (500mm diameter)
- Chromed steel and composite plastic construction
- Weight 4.5kg
- 2 year warranty



AWS-H690 £152.00
AW Select Arm & Foot Rest

Your local medical supplier is just a phone call away. See cover for full details

Prices shown are exclusive of VAT and delivery

AW Select Stainless Steel Treatment Trolleys

- Stainless steel treatment trolleys in a choice of designs
- Beautifully crafted and finished to complement your surgery or treatment room
- Strong and hardwearing with many original and unique features
- Available in a choice of sizes with or without drawers on all models

- All trolleys come with four anti-static 75mm castors, complete with bumpers on all and brakes on 2
- Green ABS plastic corner protectors and drawer handles
- 2 year warranty on all models



Select Treatment Trolley with Guard Lip and 2 Shelves

- Top shelf with guard lip on 3 sides and drop lip on front
- Bottom shelf for storage of equipment
- 2 sizes available



AWS-H250	Dimensions 600(l) x 400(w) x 850(h) mm, (24" x 16" x 34") Weight 9kg	£211.20
AWS-H225	As AWS-H250 with recessed tray	£274.10
AWS-H230	Dimensions 900(l) x 400(w) x 850(h) mm, (36" x 16" x 34") Weight 11kg	£373.60

AWS-H2015 Select Treatment Trolley with Guard Lip, 2 shelves & single drawer

- Top shelf with guard lip on 3 sides and drop lid on front
- Bottom shelf for storage of equipment
- Single stainless steel drawer
- Choice of epoxy powder coated or stainless steel



AWS-H20150	H2015 Surgery trolley – stainless steel	£299.00
AWS-H20153	H2015 Surgery trolley – epoxy	£269.00

Select Treatment Trolley with Removable Top Tray

- Stainless steel top tray lifts out for cleaning and disinfection (60mm deep)
- Bottom shelf for storage of equipment



AWS-H190	Dimensions 600(l) x 400(w) x 850(h) mm, (24" x 16" x 34") Weight 10.5kg	£211.20
AWS-H210	Dimensions 900(l) x 400(w) x 850(h) mm, (36" x 16" x 34") Weight 11kg	£252.80

AWS-H2016 Select Treatment Trolley with Guard Lip, 2 shelves & double drawer

- Top shelf with guard lip on 3 sides and drop lid on front
- Bottom shelf for storage of equipment
- Single stainless steel drawer
- Choice of epoxy powder coated or stainless steel



AWS-H20160	H2016 Surgery trolley – stainless steel	£329.00
AWS-H20163	H2016 Surgery trolley – epoxy	£299.00

Your local medical supplier is just a phone call away. See cover for full details

Prices shown are exclusive of VAT and delivery

Furniture **Surgery Trolleys**

Glamorgan Stainless Steel Instrument Trolley

- Smart surgical instrument and dressing trolleys
- Stainless steel shelves and frame
- Anti-static rubber tyred castors
- Removable and/or reversible shelves, easy to clean
- Guard rail as standard
- Available in 18", 24", 30" and 36" sizes



AWF450	18" x 18"	£239.00
AWF451	18" x 24"	£399.00
AWF452	18" x 30"	£429.00
AWF453	18" x 36"	£459.00

AWS-H225 Select Universal Trolley

- Ideal trolley for surgery use with hygienic rolled edge stainless steel top and bottom shelf
- High quality 75mm castors, 2 locking, for easy movement over any surface
- 680mm x 420mm x 800mm



AWS-H225	£274.10
Select Universal Trolley	

AWS-H2200 Universal Trolley

- A range of high quality universal trolleys ideal for busy hospital and practice use
- Flat shelves ideal for equipment storage etc
- Hygienic stainless steel construction with 75mm castors (2 locking)
- Available in 4 useful sizes



AWS-H20-000	£203.00
600 x 400 x 800mm universal trolley	
AWS-H22-00	£289.30
900 x 400 x 800mm universal trolley	
AWS-H22-100	£405.00
1000 x 500 x 800mm universal trolley	
AWS-H22-120	£465.90
1200 x 500 x 800mm universal trolley	

Select QuickStar Utility Trolley



- Multipurpose trolley manufactured from square section powder coated tubes
- Steel drawers, plastic handle.
- 50mm castors
- 81cm high x 64cm wide x 47.5cm deep
- 1 drawer

6305	£175.00
Quickstar utility trolley	
6308	£220.00
Chromostar utility trolley, as Quickstar but with chrome frame	

Your local medical supplier is just a phone call away. See cover for full details

Prices shown are exclusive of VAT and delivery

Melamine Trolleys

A range of multipurpose trolleys manufactured from high grade quality melamine and steel with powder coated chassis rails. Ideal for use in GP surgeries, examination rooms, offices and other areas where the transportation of heavy equipment will not be required. Available in Space Saver format and Standard format.



Undercouch Space Saver trolleys

- Ideal for utilising the space under fixed height couches
- Available with a choice of 1, 2 or 3 drawer combinations
- Powder coated frames RAL9002 grey white
- Solid steel drawers on linear guiding arms
- Veneer plywood without formaldehyde and with anti fade finish
- Chrome handles
- Twin castors 50mm diameter
- 15kg capacity per drawer
- Supplied flat packed but easy to assemble
- Available in two widths 40cm and 64cm
- Height 49cm Depth 47.5cm

40cm wide trolleys

6073	Select Mensa space saver trolley with 1 x 9cm deep drawer	£178.50
6074	Select Mensa space saver trolley with 2 x 9cm deep drawers	£228.40
6075	Select Mensa space saver trolley with 3 x 9cm deep drawers	£279.20

64cm wide trolleys

6079	Select Mensa space saver trolley with 1 x 9cm deep drawer	£182.60
6080	Select Mensa space saver trolley with 2 x 9cm deep drawers	£232.50
6081	Select Mensa space saver trolley with 3 x 9cm deep drawers	£283.20



Standard Height Trolleys

- Single, double and three drawer trolleys in 40cm and 64cm widths
- 82cm high, 47.5cm depth

40cm wide trolleys

6311	Auxilio Mini trolley with 1 x 9cm drawer	£198.90
6312	Auxilio Mini trolley with 2 x 9cm drawer	£248.70
6313	Auxilio Mini trolley with 3 x 9cm drawer	£299.50

64cm wide trolleys

6302	Auxilio Midi trolley with 1 x 9cm drawer	£203.00
6303	Auxilio Midi trolley with 2 x 9cm drawer	£252.80
6304	Auxilio Midi trolley with 3 x 9cm drawer	£303.50



Drawer tides

- Suitable for all 64cm wide drawers
- Manufactured from deep drawn polystyrene with a special anti soiling coating
- Rounded corners and edges are easy to wipe and keep clean
- Can be removed for complete cleaning

6191	Type A draw tidy	£24.50
3916	Type B draw tidy	£24.50

Your local medical supplier is just a phone call away. See cover for full details

Prices shown are exclusive of VAT and delivery

Furniture Accessories



Accessories		
AWS-H7000A	IV pole with support	£54.00
AWS-H7000B	Oxygen bottle holder	£125.00
AWS-H7000C	Collapsible auxiliary table	£147.00
AWS-H7000D	Cardiac massage board	£145.00
AWS-H7000E	Electrical connection board	£80.00
AWS-H7000F	Monitor/defibrillator support	£210.00
AWS-H7000G	Support for dispenser box	£135.00
AWS-H7000I	4 box dispenser (excludes support)	£125.00
AWS-H7000J	5 box dispenser (excludes support)	£125.00
AWS-H7000K	6 box dispenser (excludes support)	£125.00
AWS-H7000L	Draw divider	£74.00
AWS-H7000P	Security seal system for drawers	£135.00

AWS-H7000PD	Box of 100 seals	£99.00
AWS-H7000Q	Lateral support for sharps bin	£119.00
AWS-H7000R	Side rail for accessories	£124.00
AWS-H7000Y	Plastic waste bucket	£42.00
AWS-H7000X	Stainless waste bucket	£82.00
AWS-H7000XX	Central locking system for drawers	£114.00
AWS-H7011050	ISO basket 600x400x50mm grey	£54.00
AWS-H7012100	ISO basket 600x400x100mm grey	£84.00
AWS-H7012200	ISO basket 600x400x200mm grey	£104.00
AWS-H7021050	ISO basket 600x400x50mm transparent	£64.00
AWS-H7022100	ISO basket 600x400x100mm transparent	£94.00
AWS-H7022200	ISO basket 600x400x200mm transparent	£114.00

Your local medical supplier is just a phone call away. See cover for full details
Prices shown are exclusive of VAT and delivery

Clinical Modular Department Trolleys

A range of superior quality trolleys ideal for the busy clinic or ward which requires the very best quality at a reasonable price. Modular drawer design allows a wide variety of configurations.

These trolleys have many unique features:-

- Lightweight yet durable.
- ABS drawers are strong yet help reduce noise levels compared to stainless steel equivalents
- Easy to move
- Variety of colours for departmental coding
- Telescopic draw guides allows drawers to be opened 110% ensuring that the whole drawer is usable
- Smooth auto closing
- Handles with label holder

- Drawers accept ISO baskets with dimensions of 600 x 400 x 100 and 600 x 400 x 200
- Large selection of accessories
- Strong foldable working board
- Lateral handle for easy movement
- 100mm diameter castors for all surfaces
- Castors have brakes and rubber bumpers
- Chassis made from stainless steel
- Standard drawer size 553 x 354 x 124mm
- Large drawer size 553 x 350 x 248mm
- Overall dimensions 680 x 420 x 1040mm
- Wide selection of accessories available, please call for details



AWS-H751-00



AWS-H772-00



AWS-H773-00



AWS-H775-00

Please specify drawer colours from the standard range of green, blue, red or yellow. Additional colours available upon request

AWS-H751-00 £912.50
Select multifunction trolley with 1 x large drawer and 3 shelves

AWS-H772-00 £925.70
Select multifunction trolley with 2 standard drawers and 3 shelves

AWS-H773-00 £931.00
Select multifunction trolley with 2 standard drawers, 1 large drawer and 2 shelves

AWS-H775-00 £1045.00
Select multifunction trolley with 5 standard drawers, 1 large drawer and 1 shelf

Your local medical supplier is just a phone call away. See cover for full details

Prices shown are exclusive of VAT and delivery

Furniture **Baby Changing Units**



Baby Minder units are manufactured in the UK to the highest quality standards and combine the ultimate in safety, convenience and versatility with long lasting, clean good looks. Each unit folds neatly and discretely against the wall. Bag hook included. Available in horizontal model (along the wall) vertical model (at right angles to the wall)

174

Features

- Available in vertical and horizontal formats
- Compact ultra-slim profile
- Structural foam filled for rigidity
- Gas-shock dampened for controlled and safe opening/closing
- Heavy duty integral moulded hinges for strength and safety
- Dual liner dispensers
- Integral moulded bag hooks for convenience
- Structural material inhibits bacterial growth

Specifications

Construction: Textured, colour-fast H.D.P.E
Optional stainless steel construction available

Colour: Neutral off-white

Loading: Changing stations - up to 130kg (when correctly installed)

Retaining straps: Colour co-ordinated heavy duty nylon - fully adjustable

Opening angle: Opens to 87° (tilting horizontal surface to wall)

Installation kit: Includes fixings for stud and solid wall installations



Vertical Baby Changer

Dimensions: 87.7 x 49.6 x 87.7cm 12.1cm profile

079.002 Vertical Baby Changer **£309.60**



Horizontal Baby Changer

Dimensions: 48.3 x 74.3 x 48.3cm 9.3cm profile

079.001 Horizontal Baby Changer **£309.60**



Your local medical supplier is just a phone call away. See cover for full details

Prices shown are exclusive of VAT and delivery

AW Select Practitioner Stools and Chairs

- The AW Select practitioner stools are made to an exacting standard both in quality and in ergonomic design
- Each chair has a extra thick foam top, upholstered in synthetic leather and available in a choice of blue, black or yellow colours
- Swivel seats with gas elevation for height adjustment
- 5 point mobile castor base
- Optional backrest (chairs) and steel foot ring
- Backrests are horizontally and vertically adjustable
- Dimensions of stools 500mm diameter x 500 - 700mm height; weight 4kg
- Dimensions of chairs 600mm diameter x 500 - 750mm height; weight 9kg
- 2 year warranty

Colours Available



AWS-H1560	AW Select Practitioner Stool	£81.60
AWS-H1580	AW Select Practitioner Stool, with Foot Ring	£125.50
AWS-H1590	AW Select Practitioner Chair	£122.40
AWS-H1610	AW Select Practitioner Chair, with Foot Ring	£183.60

Please state colour required when ordering

AW Select Pony Stool



Colours Available

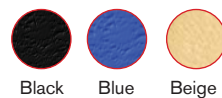

- The Pony Stool has been developed through extensive research into spinal disorders and pain
- The seat design of the pony stool allows you to sit in a natural position with a straight spine, whilst working for extended periods
- Gas-jack height adjustable and rotating seat
- 5 point mobile base
- High chrome finish
- Padded and upholstered seat in hard wearing synthetic leather in a choice of colours
- 2 year warranty

Available with following options at time of ordering. Cannot be retro fitted

AWS-S3631	Select Pony stool with height and tilt adjustable back rest	£320.00
AWS-S5663	Select Pony stool with multifunction arm rest	£405.00
AWS-S5664	Select Pony stool with height and tilt adjustable back rest and multifunction arm rest	£482.50

AWS-S3630 AW Select Pony Stool (please state colour) **£269.00**

Your local medical supplier is just a phone call away. See cover for full details

Prices shown are exclusive of VAT and delivery

Furniture Stools

Black Cat range of Practitioners Chairs and stools

Manufactured in Germany the Black Cat range of chairs and stools provide unrivalled value for money and quality construction. 5 foot black plastic frame has a 110Kg load capacity and the 37cm diameter circular seat is very comfortable, durable and easy to clean. 70mm thick upholstery has a high rebound ability which helps prevent rucking and creasing.

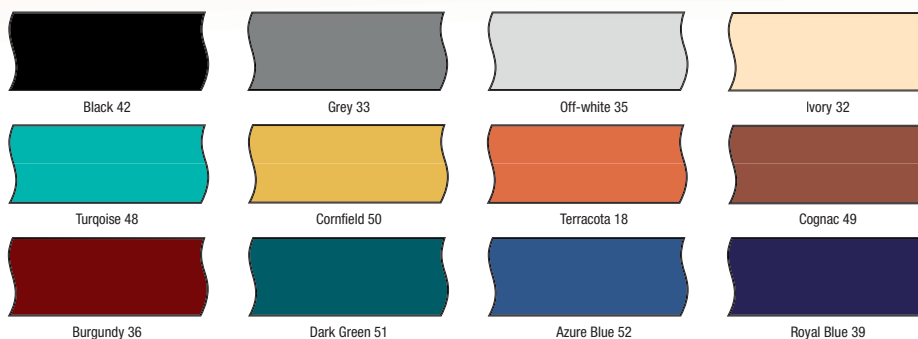

Nero stool

- Nero stool with black plastic base
- 110Kg capacity
- 47cm to 59cm height

See above for colour chart.



6999 Nero Stool (please specify colour) **£73.50**

Penny stool

- Penny stool with aluminium base
- 135Kg capacity
- 43cm to 56cm height

See above for colour chart.



6990 Penny Stool (please specify colour) **£100.00**

Comfort stool (48cm to 64cm height)

- Comfort stool with aluminium base
- 135Kg capacity
- 48cm to 64cm height
- Circumferential ring height adjuster

See above for colour chart.



5968 **£159.20**
Comfort stool, with circumferential ring height adjuster 48cm to 64cm (please specify colour)

Comfort stool (46cm to 60cm height)

- Comfort stool with aluminium base
- 135Kg capacity
- 46cm to 60cm height
- Foot ring height adjuster enable operator to maintain sterile field

See above for colour chart.



5969 **£303.50**
Comfort stool, with foot ring height adjuster 48cm to 64cm (please specify colour)

Your local medical supplier is just a phone call away. See cover for full details

Prices shown are exclusive of VAT and delivery

AW Select Ward Screens

- Available in 2, 3 and 4 sections
- Removable vinyl curtains available in blue, green or white
- Unless specified white curtains supplied as standard
- Curtains supplied fitted
- 50mm diameter free rolling castors
- High quality chrome finish
- Folds flat when not in use
- Very stable when in use and when folded



50mm diameter free rolling castors

Colours Available

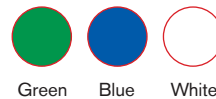

AWS-H620	£131.60
2 section chrome ward screen with curtains (please specify colour) 1400mm overall length - 700mm x 400mm x 1800mm	
AWS-H63001	£182.60
3 section chrome ward screen with curtains (please specify colour) 2100mm overall length - 700mm x 400mm x 1800mm	
AWS-H63001/4	£231.50
4 section chrome ward screen with curtains (please specify colour) 2800mm overall length - 700mm x 400mm x 1800mm	

Your local medical supplier is just a phone call away. See cover for full details
Prices shown are exclusive of VAT and delivery

Furniture Screens

Ropimex FG95 Mobile Screen

Easy to use within a few seconds and just as easy to put away. The FG95 can be supplied with 1 or 2 telescopic arms and screens and is ideal for mobile screening.

Ideal for use in such areas as:

- Patient accommodation in corridors
- In multi bed rooms
- In the emergency department
- In intensive care
- In the gynaecology suite
- Complete Ropimex Brochure available upon request

Colours Available



ME
Melon



P
Peach

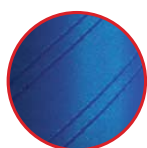

AZ
Azure



HB
Light Blue

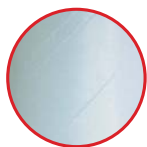

W
White

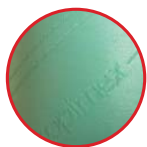

HG
Light Green



R
Rose



G
Yellow



FG95/RTI2.2

£644.60

Mobile base with 4 castors (2 locking). Maximum height 165cm (66") and telescopic arm, maximum extension 220cm (88") with 17 rings. Arm telescopes, folds and swivels

TCS212

£101.00

Trevira flame retardant curtains to fit above. 230 x 140cm (92" x 56") Available in following colours: Melon, Peach, Azure, Light blue, White, Light green, Rose and Yellow (please specify colour required when ordering)

For second telescopic arm please order as follows:

UKB

£78.60

Universal clamp for mounting second arm RTI1.6 onto mobile base FG95

RTI1.6

£258.90

Telescopic arm, maximum extension 160cm (64") with 13 rings. Arm telescopes, folds and swivels

TCS152

£94.40

Trevira flame retardant curtains to fit above. 170 x 140cm (68" x 56") Available in following colours: Melon, Peach, Azure, Light blue, White, Light green, Rose and Yellow (please specify colour required when ordering)

Your local medical supplier is just a phone call away. See cover for full details

Prices shown are exclusive of VAT and delivery

Ropimex Universal Screen System

Where space is at a premium the Ropimex Universal Screen System is ideal. This telescopic and folding system allows the screen to be neatly stored against the wall and out of the way, when not in use. You just lift and lock the bar and extend the telescopic pole, when the screen is required. There are no fiddly adjustments to be made.

- Made from tough, lightweight materials including anodised aluminium, glass-fibre reinforced synthetics and stainless steel
- Available in 2 extension lengths of 150cm and 210cm (160cm and 220cm for folding system) and includes 10 or 13 colour coded, anodised curtain rings

- The wall holder is resin coated in white and made from strong, pressed aluminium. The screw fixings are hidden from view
- Ropimex curtains are made from Trevira CS flame-retardant material, available in 8 colours (see swatches) and are machine washable to 60 degrees
- The Ropimex brand is your guarantee of a system that is safe, simple to use and of superb quality
- Over 60,000 satisfied users worldwide

Colours Available



ME
Melon



P
Peach

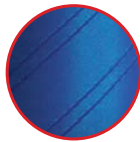

AZ
Azure

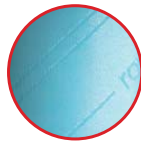

HB
Light Blue

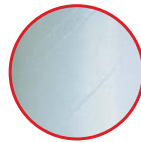

W
White



HG
Light Green

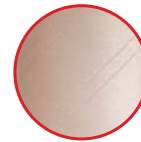

R
Rose

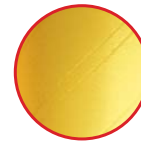

G
Yellow



AWF800/150	£411.10
Ropimex telescopic cubicle screen 69cm–150cm complete with Trevira CS curtains (please state colour code)	
AWF800/210	£451.70
Ropimex telescopic cubicle screen 89cm–210cm complete with Trevira CS curtains (please state colour code)	
AWF810/160	£448.70
Ropimex telescopic & folding cubicle screen 82cm–160cm complete folded 38cm with Trevira CS curtains (please state colour code)	
AWF810/220	£478.10
Ropimex telescopic & folding cubicle screen 103cm–220cm complete folded 38cm with Trevira CS curtains (please state colour code)	

Ropimex offer a large range of cubicle and couch screening systems to suit all requirements. Waterproof shower screens are also available. Please call for further information or for a no obligation free quotation.

Your local medical supplier is just a phone call away. See cover for full details

Prices shown are exclusive of VAT and delivery

Furniture Disposable Ward Screen Curtains

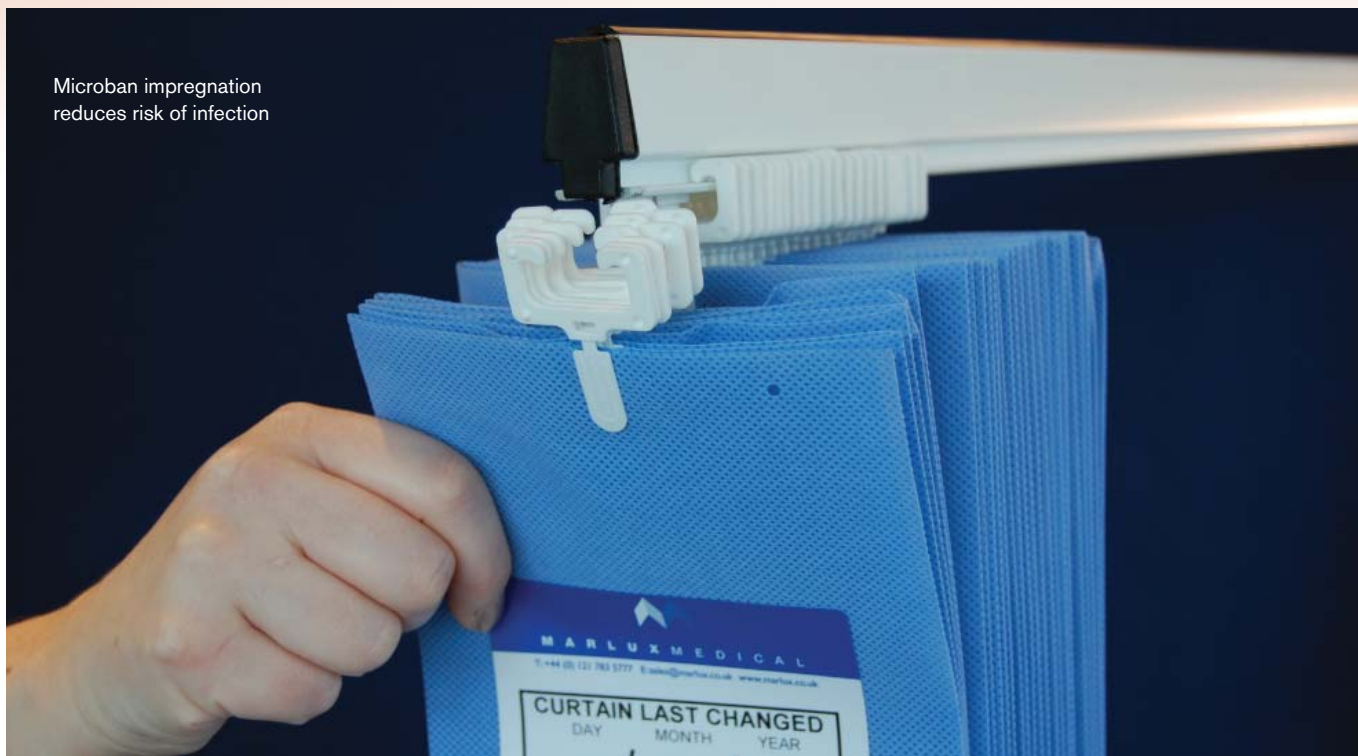

Microban impregnation reduces risk of infection

Marlux Fast Fit Antibacterial Disposable Curtains

Fast-Fit Curtains

F18/1950A-SB Summer Blue 1.8mtr wide	£16.50
F18/1950A-PB Pastel Blue 1.8mtr wide	£16.50
F18/1950A-BS Bali Sand 1.8mtr wide	£16.50
F18/1950A-FG Forest Green 1.8mtr wide	£16.50

F42/1950A-SB Summer Blue 4.2mtr wide	£29.00
F42/1950A-PB Pastel Blue 4.2mtr wide	£29.00
F42/1950A-BS Bali Sand 4.2mtr wide	£29.00
F42/1950A-FG Forest Green 4.2mtr wide	£29.00

F72/1950A-SB Summer Blue 7.2mtr wide	£33.55
F72/1950A-PB Pastel Blue 7.2mtr wide	£33.55
F72/1950A-BS Bali Sand 7.2mtr wide	£33.55
F72/1950A-FG Forest Green 7.2mtr wide	£33.55

Colours Available

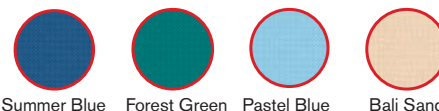

Unique hooking system enables rapid and efficient installation or changeover of long runs of curtains. Simply feed multiple lengths on to the Fast-Fit system to create instant privacy screening.

These curtains are impregnated with microban to ensure the growth of bacteria is minimised

This antibacterial quality enhances existing hygiene measures within healthcare facilities

- Provide continuous antibacterial efficacy that cannot wear or be washed off
- Twenty four hour protection for the full useful life of the curtain
- Manufactured from high quality, durable and recyclable non-woven 100% polypropylene fabric, hook and label
- Microban 3G Silver™ antibacterial technology built-in at the point of manufacture to provide a valuable and effective tool to aid in the fight in infection control
- Incorporates unique welded and stackable glider design to enable Fast-Fit curtains to be used on all curtain track systems
- Simple track conversion using the Adaptiv-Track may be required which provides a fast and efficient method of loading and unloading disposable curtains
- Three standard widths: 1.8m, 3.6m and 7.2m with 1950mm drop
- 4 standard stock colours
- Unique anti-peel label with date last changed
- Fire retardant to BS5867-2:2008 type C

Components for Rail System

C100/9 Fast-Fit glide hooks - pk of 200	£80.00
MK4Insert Adapta-Track 18mtr length	£180.00
QRM Retaining Pins - 100 per rail	£80.00

Your local medical supplier is just a phone call away. See cover for full details

Prices shown are exclusive of VAT and delivery



Microban impregnation reduces risk of infection

Universal Disposable Curtain

Universal curtain system promotes compatibility with most existing hooking systems.

- Provide continuous antibacterial efficacy that cannot wear or be washed off
- Twenty four hour protection for the full useful life of the curtain
- Manufactured from high quality, durable and recyclable non-woven polypropylene fabric incorporating an eyelet design for easy loading to existing glider hooks
- Microban 3G Silver™ antibacterial technology built-in at the point of manufacture to provide a valuable and effective tool to aid in the fight in infection control.
- Simple track conversion using the Marlux Adapt-a-Track may be required which provides a fast and efficient method of loading and unloading disposable curtains
- Three standard widths: 1.8m, 3.6m and 7.2m with 1950mm drop
- 4 standard stock colours
- Unique anti-peel label with date last changed

Colours Available

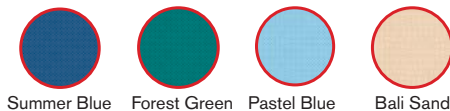

Summer Blue Forest Green Pastel Blue Bali Sand

Components for Rail System

C100/9 Fast-Fit glide hooks - pk of 200	£80.00
MK4Insert Adapta-Track 18mtr length	£180.00
QRM Retaining Pins - 100 per rail	£80.00

Universal Curtains

U18/1950A-SB Summer Blue 1.8mtr wide	£16.50
U18/1950A-PB Pastel Blue 1.8mtr wide	£16.50
U18/1950A-BS Bali Sand 1.8mtr wide	£16.50
U18/1950A-FG Forest Green 1.8mtr wide	£16.50
U42/1950A-SB Summer Blue 4.2mtr wide	£29.00
U42/1950A-PB Pastel Blue 4.2mtr wide	£29.00
U42/1950A-BS Bali Sand 4.2mtr wide	£29.00
U42/1950A-FG Forest Green 4.2mtr wide	£29.00
U72/1950A-SB Summer Blue 7.2mtr wide	£33.55
U72/1950A-PB Pastel Blue 7.2mtr wide	£33.55
U72/1950A-BS Bali Sand 7.2mtr wide	£33.55
U72/1950A-FG Forest Green 7.2mtr wide	£33.55

Your local medical supplier is just a phone call away. See cover for full details

Prices shown are exclusive of VAT and delivery

Furniture Tables & Bowls

AW Select Mayo Instrument Table

- AW Select 'Mayo' style instrument table
- All stainless steel construction
- Adjustable height table from 750 - 1200mm
- Tray is 20mm deep and removable for cleaning and sterilisation
- Castor base is specially designed to fit neatly under the couch or operating table
- 75mm anti-static castors, 2 with brakes and all with bumpers
- Overall dimensions 600(w) x 400(d) x 750 - 1200(h) mm
- Weight 7kg
- Optional single column hydraulic version available
- 2 year warranty



AWS-H260 AW Select Mayo Instrument Table **£229.40**

AWS-H280 AW Select Hydraulic Mayo Instrument Table **£812.00**

AW Select Basin Holder

- Single or twin basin holder for the convenient disposal / discarding of used instruments, dressings etc
- Adjustable height from 800 - 1500mm (single is fixed height)
- Supplied with 2 conical stainless steel basins (1 with single unit)
- 5 wheel mobile base
- All stainless steel construction
- Dimensions 500(w) x 800 - 1500(h) mm
- Weight 6kg (excluding basins)
- 2 year warranty



AWS-H490 AW Select Basin Holder with 2 basins **£203.00**

AWS-H490S AW Select Single Basin Holder Fixed Height **£177.50**

Mayo Table

- Mobile Mayo table with height, swivel and angle adjustments
- Equipment can be ideally placed close to the patient and practitioner
- Stainless steel frame and tray
- 3" rubber tyred anti-static castors
- Adjustable height from 84cm to 140cm



AWF490 Mayo Table **£229.40**

AWF490/11006 **£41.50**
Stainless Steel Tray 530mm x 320mm

AW Select Kickabout Bowl

- Stainless steel kickabout bowl on 5 wheel base
- Ideal for general surgical disposal
- Removable bowl for easy cleaning and sterilisation
- All stainless steel construction
- Dimensions 360(dia) x 210(h) mm
- Weight 2kg
- 2 year warranty



AWS-H530 **£127.50**
AW Select Kickabout Bowl

Your local medical supplier is just a phone call away. See cover for full details

Prices shown are exclusive of VAT and delivery

Black Cat Eccotop Equipment Table

- Stainless steel minor ops equipment table
- Height adjustable 67 – 107cm
- 48cm x 38cm platter with 2 raised edges
- Epoxy chassis and base
- 5 castors (2 conductive)



4065 Black Cat Instrument table **£236.50**

Black Cat Mobitop Instrument Table

- Stainless steel minor ops equipment table
- Height adjustable 67 – 107cm
- 48cm x 38cm platter with 2 raised edges
- Stainless steel chassis and heavy chrome plated base
- 135kg load capacity
- 5 castors (2 conductive)



4267 Black Cat Mobitop Instrument table **£290.30**

Black Cat cushion

- Black Cat cushion for all table tops
48 x 38 x 2cm

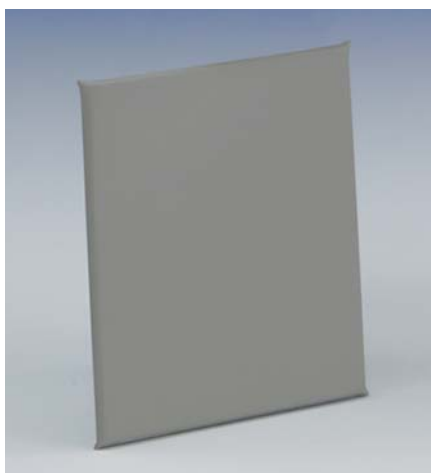

4056 Black Cat cushion **£32.70**

Bristol Maid Oxygen Cylinder Trolley

- Robust trolley for the safe and easy movement of gas cylinders
- Tubular steel construction with tough blue epoxy resin finish
- 1 or 2 chains hold cylinders in position
- Available for cylinder sizes AF, E & J
- 20mm anti-static wheels are smooth to manoeuvre and stationary when trolley is upright

CYT/J1	£277.10
Trolley for 1 x 'J' cylinder 510(w) x 425(d) x 1280(h) mm	
CYT/E1	£121.40
Trolley for 1 x 'E' cylinder 310(w) x 320(d) x 950(h) mm	
CYT/AF1	£136.70
Trolley for 1 x 'AF' cylinder 310(w) x 260(d) x 825(h) mm	



Your local medical supplier is just a phone call away. See cover for full details
Prices shown are exclusive of VAT and delivery

Furniture Caretray Trolleys

Bristol Maid Caretray Trolleys

The Caretray trolley from Bristol Maid is ideal for the organisation and storage of your medical sundries (i.e. dressings, treatment packs, sutures etc) and/or medical equipment

The clear 'Styrolux' high impact trays have 4 movable dividers, clip-on label cover, integral handle. Each tray is 360mm x 430mm with 100 or 160mm depth

Single piece frame requires no on-site construction

Tough light-blue epoxy resin finish framework with white easy-clean side panels

Plastic top tray, 20mm deep

100mm castors with ring-buffers and 2 braking

Bristol Maid Caretray Trolley CT208 453L

- First column with 4 x 100mm deep trays
- Second column with 3 x 160mm deep trays
- Overall dimensions: 1030mm (w) x 575mm (d) x 785mm (h); weight 31kg

CT208 453L

£624.30



Bristol Maid Caretray Trolley CT110 352L

- Single column with 3 x 100mm and 2 x 160mm deep trays
- Overall dimensions: 575mm (w) x 575mm (d) x 1045 (h); weight 24kg

CT110 352L

£503.00

Bristol Maid Individual Patient Drug Dispensing Trolley

- Popular individual patient / unit dosage drug trolley, stores patients own prescription in individual tray
- Supplied with 6 adjustable metal shelves and 18 x 'A' trays and 12 x 'C' trays as standard
- Each tray has a cardholder for patients details
- Laminated work top space
- 'Push' handle, hinges out of the way when not in use
- 3 x removable and adjustable door shelves
- Available with optional 'security bracket' for fixing in place when not in use

UD250

Bristol Maid Patient Drug Dispensing Trolley

£975.00



Your local medical supplier is just a phone call away. See cover for full details

Prices shown are exclusive of VAT and delivery

Bristol Maid Refuse Bag Holder

- Freestanding refuse bag holder with pedal operated aluminium lid
- Stainless steel pedal and linkages for durability
- Bag is retained by means of an expanding strap
- Available in 2 capacities:
 - 50 litre (suggested minimum bag size 1320mm (circ) x 540mm)
 - 75 litre (suggested minimum bag size 1320mm (circ) x 770mm)
- Easy to keep clean and hardwearing with blue epoxy resin finish



BH015 Refuse Bag Holder 50 litre	£107.10
---	----------------

BH030 Refuse Bag Holder 75 litre	£116.30
---	----------------

Bristol Maid Wall Mounted Bag Holder

- Wall mounted refuse bag holder with hand operated aluminium lid
- Bag is retained by means of an expanding strap
- Available in 20 and 50 litre capacities
- Easy to keep clean and hardwearing with blue epoxy resin finish



BH035 Wall Mounted Bag Holder 20 litre	£35.70
---	---------------

BH040 Wall Mounted Bag Holder 50 litre	£42.90
---	---------------

Your local medical supplier is just a phone call away. See cover for full details
Prices shown are exclusive of VAT and delivery

Furniture Drug Cabinets

PC and Controlled Drugs Cabinets

- Single point locking
- Anti pick and anti drill locks
- 12v DC lighting and warning system
- Nurse call system ready
- 0.9mm mild steel construction
- Mounting holes provided in back
- Tested to BS2881:1989



PC005



PC065



PC145



PC205

PC005 300w x 300d x 600h with 3 full shelves with mains lighting	£299.50
PC010 300 x 300 x 600 with 3 full shelves with mains lighting	£279.20
PC065 500 x 300 x 900 with 4 full shelves	£481.90
PC145 800 x 300 x 600 with 6 full shelves	£472.00
PC205 1000 x 300 x 900 with 8 full shelves	£604.00

DC Controlled Drugs Cabinets

- This range of cabinets are designed to meet and exceed the current requirements of 'The Misuse of Drugs (safe custody) Regulations 1973, which governs the storage of controlled drugs throughout the UK
- Cabinets are made from heavy 16 gauge mild steel with complex overlapping door and frame design, making it very difficult to 'lever' the door
- Integral return on door makes it impossible to remove even if the robust piano hinge is cut or forced
- Heavy duty deadlock is not mastered or numbered, has anti-saw rollers in lock and is secured by a back plate
- Gas welded hinges
- IT IS RECOMMENDED that all CD cabinets are secured firmly to a solid wall using expanding bolts. Instructions are included



CD005



CD010



CD015



CD020



CD025



CD030



CD035

CD005 210w x 270d x 300h, weight 8kg, 1 shelf	£208.10
CD010 335 x 270 x 300, weight 9kg, 1 shelf	£220.30
CD015 335 x 270 x 550, weight 17kg, 2 shelves	£260.90
CD020 500 x 300 x 550, weight 20kg, 2 shelves	£461.90
CD025 500 x 300 x 850, weight 37kg, 3 shelves	£644.60
CD030 500 x 450 x 850, weight 42kg, 3 shelves	£685.20
CD035 500 x 450 x 1250, weight 59kg, 4 shelves	£776.50

Your local medical supplier is just a phone call away. See cover for full details

Prices shown are exclusive of VAT and delivery

AW Select Infusion Stand

- Height adjustable from 1000mm to 1950mm (40" x 78")
- Solid aluminium base with 5 legs
- A choice of either 2 or 4 hooks
- 2kg per hook weight limit



AWS-H1064/3	Select Infusion stand with 2 hooks	£87.80
AWS-H3064/2	Select Infusion stand with 4 hooks	£101.00

AW Provita Op Theatre Infusion Stand

- Stainless steel construction
- Tube diameters, 25/18mm
- Single handed height adjustment
- 1350-2150mm height range
- Stainless steel hooks, 2 kg per hook
- 80mm mono castors, 2 antistatic and lockable, 3 normal
- Seamless welded base, easy to keep clean
- Available in Magnetic Resonance Compatible Format (test certificate available)
- Safety hooks
- Liquid protection between inner and outer tube
- Inner tube remains in set position - cannot drop
- Polished tubes



I-O 12112	AW Provita OP Infusion Stand	£263.90
I-M 12112	AW Provita MRC Compatible Stand	£299.50

AW Provita Infusion Stand

- Stainless steel pole
- Height adjustable by screw lock 1000mm to 1950mm
- Plastic hooks (4) 2kg per hook
- Can be supplied with blue, black or green hooks, please specify when ordering
- Stable high tensile plastic castor base
- 5 twin 50mm castors, 2 x antistatic, 3 x normal
- Easy to construct
- 3kg total weight, approx
- Safety hooks
- Liquid cap between outer and inner tube
- 1 screw assembly



AWF702	AW Provita Infusion Stand, stainless steel	£70.40
---------------	--	---------------

AW Provita Standard Infusion Stand

- Chrome finish main pole
- 4 plastic hooks, 2kg per hook
- Screw height adjustment, 1350mm to 2150mm
- Base diameter 635mm
- 80mm castors with 2 x antistatic and lockable, 3 x normal
- 3.9kg weight
- Chrome finish legs
- Liquid cap between outer and inner tube
- Easy to mount
- Safety hooks

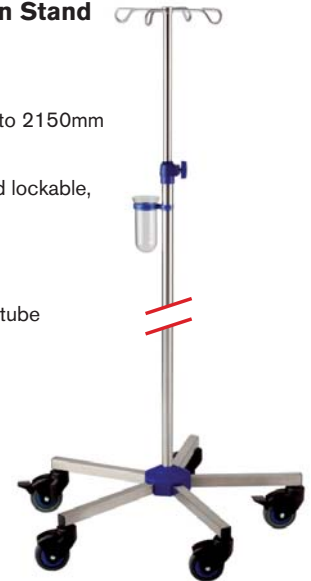

I-N11122	AW Provita Standard Infusion Stand	£137.70
-----------------	------------------------------------	----------------

Paediatric IV Drip Stands

Enhance your environment and aid patient rehabilitation with this colourful range of children's IV drip stands.

- Colour options of red with airplane castors, green with mouse castors or yellow with airplane castors

Material: chromed steel/ plastic
 Tube diameter: 25/ 18mm
 Bottle holder: plastic 4 hooks - 2kg per hook
 Adjustment: screw safety height adjustment
 Height adjustment: 1,350 - 2,150mm
 Base diameter: 635mm
 Castors: 4 x 50mm
 Total weight: 3kg

I-HA4125	Red with airplane castors	£109.00
I-HA4126	Green with mouse castors	£109.00
I-HA4130	Yellow with airplane castors	£109.00



Your local medical supplier is just a phone call away. See cover for full details

Prices shown are exclusive of VAT and delivery

Furniture Infusion Stands

Black Cat 4 Hook Drip Stands



A range of high quality colour coded drip stands all manufactured to the highest quality and suitable for all normal and practice use.

- Extending tube is hard chrome plated
- Drip hooks are stainless steel with 3kg load capacity
- Base has a solid metal centre and is proofed up to 135kg laden weight
- Castors are double sided and 2 are electrically conductive
- Shatter proof drip vessel

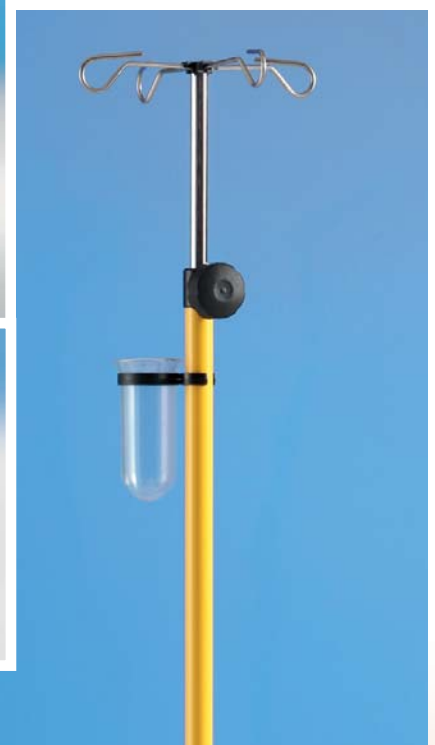

4012 5002 Ultramarine drip stand	£79.00
4012 1023 Traffic light yellow drip stand	£79.00
4012 9002 Grey white drip stand	£79.00
4012 6001 Emerald green drip stand	£79.00
4012 3000 Flame red drip stand	£79.00
4057 Handle for 25mm diameter drip stand	£18.50

Your local medical supplier is just a phone call away. See cover for full details

Prices shown are exclusive of VAT and delivery

Wall mounted swivelling infusion arms

Ideal for stationary cubicle systems and intensive care situations. Available in 2 lengths. Require mountings shown right.



RIA99

- Maximum reach of 100cm
- Weight of arm 0.5kg
- 2 infusion hooks
- Maximum load per hook - 1.25kg

RIA99 Swivelling arm **£89.80**

WH95 **£82.00**
Wall mount for swivelling arm



RIA35

- Maximum reach of 35cm
- Weight of arm 0.35kg
- 2 infusion hooks
- Maximum load per hook - 4.0kg

RIA35 Swivelling arm **£60.20**

WH95 **£82.00**
Wall mount for swivelling arm

IV Angled Pole

- Ideal for placing IV bags etc away from the wall and directly above the patient
- Height adjustable from 1180mm to 1510mm.
- One handed height adjustment
- 2 x 45° angles place bags directly above patient
- 4 safety hooks each with capacity of 2kg per hook
- Supplied with wall rail mount and wall support which prevents twisting
- Inner tube remains in set position



Please order wall rail separately

I 100 221 2 **£290.30**
Angled IV pole with wall clamp and wall support

Ceiling Mounted IV Pole

Ideal for when floor space is at a premium. By combining numerous ceiling hooks, one pole may be used in many different areas so minimising the investment necessary. Ideal for use in GP surgeries, treatment rooms and intensive care.

Specifications

- Stainless steel
- Tube diameter 18mm main tube with 14mm sliding tube
- 4 hooks with 2kg per hook capacity
- Total maximum load 15kg
- One hand adjustment

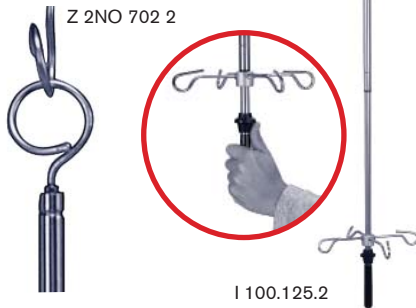

Z 2NO 702 2 Ceiling hook **£50.00**

I 100.125.2 IV pole for room height of 2.5m. Adjustable range 73-102cm **£370.50**

I 100.131.2 IV pole for room height of 3.1m. Adjustable range 103-162cm **£394.90**

I 100.135.2 IV pole for room height of 3.5m. Adjustable range 123-202cm **£421.30**

Please note other ceiling heights are available upon request

Mountings available for arms



WH95

- Wall holder in white
- For fixing to solid wall

WH95 **£82.00**
Wall holder in white



GSH/F

- Holder for fixed rail of dimensions from 10mm to maximum 25mm height of rail

GSH/F **£87.80**
Holder for fixed rail

Wall Rail Systems

- Stainless steel
- Available in 100, 150, 200, 250 and 300cm lengths
- Ideal where it is necessary for equipment to be semi-mobile
- Rail dimensions 25 x 10mm

- Capacity 100kg per metre



Z 2NO 719 2 100cm rail **£94.90**

Z 2NO 670 2 150cm rail **£142.80**

Z 2NO 671 2 200cm rail **£188.70**

Z 2NO 672 2 250cm rail **£235.50**

Z 2NO 673 2 300cm rail **£284.20**

IV Pole (Intensive Care System)

- 4 or 6 hook mounts each with 2kg capacity
- Stainless steel
- One handed adjustment
- With wall rail clamp

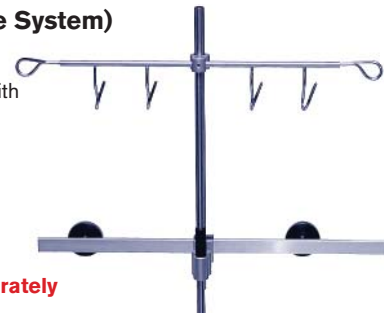

Please order wall rail separately

I 100 927 2 4 hook IV with clamp **£251.80**

I 100 929 2 6 hook IV with clamp **£269.00**

IV Straight Pole (General System)

- Stainless steel
- One hand adjustment
- Min. length 1150mm max. 1700mm
- 1 wall rail clamp and 1 wall steady support to prevent twisting
- 3 hooks, load capacity 2kg per hook
- Drip vessel and holder
- Safety hooks

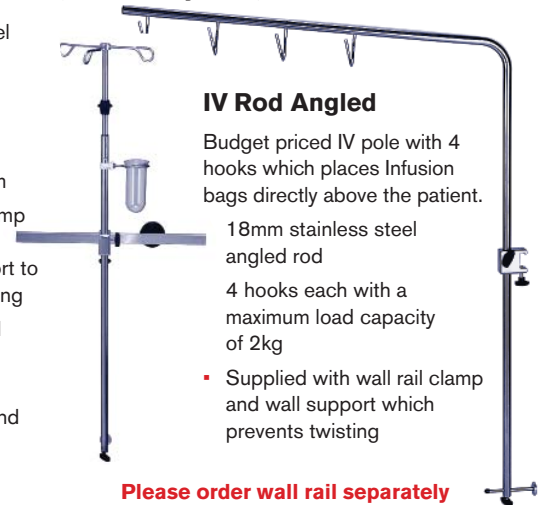

IV Rod Angled

Budget priced IV pole with 4 hooks which places Infusion bags directly above the patient.

- 18mm stainless steel angled rod
- 4 hooks each with a maximum load capacity of 2kg

- Supplied with wall rail clamp and wall support which prevents twisting

Please order wall rail separately

I 100 052 2 **£222.30**
IV pole with wall clamp and wall support

M 000 900 4 **£252.80**
Angled IV pole with clamp and wall support

Your local medical supplier is just a phone call away. See cover for full details

Prices shown are exclusive of VAT and delivery

Furniture X-Ray Viewers

AW X-Ray Viewers

- Single, double, triple, quadruple, and 4 screen vertical models X-ray viewing boxes with individual on/off switch
- Mild steel construction in white enamel finish, with chrome trim
- Fluorescent illumination system with on/off switch on front of unit
- Simple to wall mount, supplied with fixings
- Multiviewers are horizontally displayed except for AWF755

AWF751	Single X-ray viewer 38w x 48h x 10d cm	£127.50
AWF752	Double X-ray viewer 74w x 48h x 10d cm	£198.90
AWF753	Select triple X-ray viewer 110w x 48h x 10d cm	£289.30
AWF754	Select quadruple X-ray viewer 148w x 48h x 10d cm	£340.10
AWF755	Select quadruple X-ray viewer vertical fitment (single switch) 33w x 125h x 11.5d cm	£258.90
EL164	32w Replacement bulb	£17.00



190



Select Desk-top X-ray Viewer

- This compact X-ray viewing box is perfect for rooms with limited wall space and for studying x-rays at your desk
- The base is designed so the box sits at a comfortable working angle
- Stable base and tough construction
- White epoxy coated resin finish
- Even light dispersion throughout the screen
- Mains powered with simple front mounted on/off switch
- Dimensions; 380mm (w) x 515mm (h) x 190mm (d)
- 5.5kg (weight)

AWF759	Select Desk-top X-ray viewer	£137.70
AWF758	Select Desk-top double X-ray viewer	£218.30
EL164	32w Replacement bulb	£17.00

Your local medical supplier is just a phone call away. See cover for full details
Prices shown are exclusive of VAT and delivery

Complete units designed to provide cost effective waiting room bench systems

H2000 Bench System

- Anatomically shaped, independent seats
- ABS plastic seat
- Colours: black, blue or grey
- Levelling leg supports
- Black enamelled steel frame
- Seat to floor height: 420mm
- Backrest to floor height: 760mm
- Seat width: 380 x 380mm
- Gap between seats: 100mm



AWS-H2000-2 **£185.00**

ABS bench system – 2 seats
970mm wide x 610mm depth

AWS-H2000-3 **£230.00**

ABS bench system – 3 seats
1520mm wide x 610mm depth

AWS-H2000-4 **£283.00**

ABS bench system – 4 seats
1940mm wide x 610mm depth

H4000 Bench System

- Anatomically shaped, independent seats
- Natural beech plywood seats
- Levelling leg supports
- Black enamelled steel frame
- Seat to floor height: 420mm
- Backrest to floor height: 850mm
- Seat width: 400 x 400mm
- Gap between seats: 100mm



AWS-H4000-2 **£265.00**

Plywood bench system – 2 seats 970mm wide x 610mm depth

AWS-H4000-3 **£345.00**

Plywood bench system – 3 seats 2000mm wide x 610mm depth

AWS-H4000-4 **£438.00**

Plywood bench system – 4 seats 2600mm wide x 610mm depth

H5000 Bench System

- Anatomically shaped, independent seats
- Blue fabric cushioned seats
- Levelling leg supports
- Black enamelled steel frame
- Seat to floor height: 450mm
- Backrest to floor height: 900mm
- Seat width: 400 x 400mm
- Gap between seats: 100mm



AWS-H5000-2 **£309.00**

Fabric cushion bench system – 2 seats 970mm wide x 610mm depth

AWS-H5000-3 **£345.00**

Fabric cushion bench system – 3 seats 2000mm wide x 610mm depth

AWS-H5000-4 **£437.00**

Fabric cushion bench system – 4 seats 2600mm wide x 610mm depth

Your local medical supplier is just a phone call away. See cover for full details

Prices shown are exclusive of VAT and delivery

Scales & Height Measures Health

Legislation within the EU determines that approved scales must be used when diagnosing, determining treatment and prescribing however there are situations within the home, sports and health fields where a non approved scale is perfectly acceptable. We are pleased to present a wide range of high quality, reliable and accurate scales from ADE, Nagata and Soehnle which are ideal for such applications.

For ease of use this section is categorised as follows:

- 1 Floor Scales
- 2 Column Scales

1 Floor Scales

Soehnle 6163

The classic floor scale with easy to read scale and 1Kg graduations. Sturdy and reliable.

- Maximum weight 160Kg
- Graduations 1.0Kg
- Dimensions 320 x 430 x 70mm



6163.01.001

Soehnle Classic Floor Scale

£60.20

Soehnle 7840

A combination of modern digital and traditional analogue displays with 'Instant On' start function.

- Large tread area with anti slip surface ideal for gyms and other areas.
- 25mm high digital display
- Motor operated analogue dial display
- Battery operated via 4 x 1.5v AA batteries (included)
- Auto off
- Kgs/lbs switchable
- Maximum weight 180Kg
- Graduations 100g
- Dimensions 325 x 550 x 120mm



7840.01.001

Soehnle Combi Floor Scale

£152.00

Your local medical supplier is just a phone call away. See cover for full details

Prices shown are exclusive of VAT and delivery

Medically Approved Scales & Height Measures

ADE Floor scale with remote display Class III

With a 250Kg capacity this scale is ideal for all applications including Bariatric assessment

- 250Kg capacity
- 100g graduation
- 310mm x 275mm platform size
- Large 25mm remote LCD display
- Kgs/lbs selectable
- Tare, Hold and BMI
- PreTare function with 10 memories



M300020

Floor Scale remote readout

£701.80

SOEHNLE
PROFESSIONAL



Soehnle MediScale 7732

- Approved to Class III, MPG Class 1
- 250Kg capacity
- 50g/100g graduation
- 405mm x 325mm platform
- Antislip surface
- 15mm high LED display
- Instant on function
- Mains power
- Kg/lbs display
- Optional Blue Tooth or GSM connection

7732.01.001

Soehnle 7732 Class III floor scale

£649.60

Soehnle 7701

- Approved to Class III, MPG Class 1
- 250Kg capacity
- 50g/100g graduation
- 310mm x 275mm platform size
- BMI, Hold and Dialysis functions
- Easy to clean platform surface
- 20mm backlit LCD display
- Table and wall bracket included
- Kg or lbs reading
- Product weight 8Kg
- Optional carry case



7801.70.002

Soehnle 7701 Remote readout floor Scale with case

£668.90

Your local medical supplier is just a phone call away. See cover for full details

Prices shown are exclusive of VAT and delivery

Scales & Height Measures **Baby Scales**

ADE M114000

- Ideal baby and toddler scale with removal plastic tray
- Tare and hold function
- Low battery indicator
- Mains adaptor and battery operation
- Ideal for domiciliary visits
- 15Kg capacity
- Graduation, 5g < 7.5Kg > 10g
- Tray dimensions 560 x 280 x 85mm
- Product weight 3.3Kg
- Optional carry case



ADE M114000
Baby/Toddler scale

£281.00

ADE

ADE



ADE M104000

- Class III approved
- 15Kg capacity
- 5g graduation
- Safe and easy to clean baby tray
- Large, 20mm LCD display
- Kgs/lbs selectable display
- Auto Zero setting and function test
- Mains and rechargeable battery
- Tray dimensions 535 x 275 x 60mm
- Product weight 4.1Kg



ADE M104000
Baby scale

£486.20

Soehnle 7725 Baby Scale

When the best is required Model 7725 fulfils all the requirements for a modern and elegant Baby Scale

- Approved to Class III
- 15Kg capacity
- 2g/5g graduation
- Platform 600 x 355 x 120mm
- Taring function for blankets, nappies etc
- Steady weight display even for restless patients through filtering and hold functions
- High contrast LCD with 20mm digit height
- Mains and battery operation
- No edges or grooves to clean
- Kg/lbs display
- Measuring rod available as an optional extra



SOEHNLE
PROFESSIONAL

7725.01.001 Soehnle 7725 Baby Scale

£760.30

5005.10.001 Soehnle 5005 Measuring Rod

£178.50

Your local medical supplier is just a phone call away. See cover for full details

Prices shown are exclusive of VAT and delivery

Nagata BW-1330M Bariatric with Handrail

Many larger patients can be unsteady on their feet and this Nagata model offers the security of an encompassing handrail at a very reasonable cost.

- 300Kg capacity
- 100g graduation
- BMI, Tare, Hold and Recall functions
- Large easy to read digital display
- Rechargeable battery
- Durable metal construction
- Non skid surface
- Large stable platform, 600mm x 600mm x 60mm high
- Hand rail on 3 sides
- Adjustable rubber feet to compensate for uneven floors
- Rotating head can be set in any desired operator position
- Rear mounted castors for easy manoeuvring
- 2 year warranty
- 23.4kg product weight
- Height measure can be retrofitted



BW-1330M Negata Class III Bariatric column scale	£604.00
HMA Height Measure, 80-200cm ran	£50.00

Soehnle 7730 Class III Column Scale

Style and function personified, the Soehnle 7730 offers the very best in modern design with its sleek style and high performance. The 7730 is ideal for the surgery that demands the best and most stylish equipment.

- Approved to Class III, MPG class 1
- 250Kg capacity
- 50g/100g graduation
- 13.6kg product weight
- Large weighing platform, 369 x 405mm
- Antislip surface
- Simple to use
- Tare key on back of display
- No keys on front panel
- Extremely easy to clean and keep hygienic
- Backlit LED with 15mm digit height
- Mains powered
- Auto off
- Measures in KGs or lbs
- Optional USB port for PC/IT network capabilities
- 2 year warranty



SOEHNLE
PROFESSIONAL



7730.01.001 Soehnle Column Scale	£1350.00
Also available with integral measuring rod	
7731.01.001 Soehnle Column Scale with integral height rod	£1395.00

Your local medical supplier is just a phone call away. See cover for full details

Prices shown are exclusive of VAT and delivery

Scales & Height Measures **Wheelchair Scales**

Nagata BW-5160M

This scale with optional robust folding handrail allows weighing of wheelchair bound patients, patients with walking aids and patients sitting on a stationary chair.

- 300Kg capacity
- 100g graduation
- BMI, Tare, Hold and Recall functions
- Large easy to read digital display
- Rechargeable battery
- Durable metal construction
- Non skid surface
- Large stable platform, 760mm x 800mm (flat portion)
- Product size 1080mm x 990mm x 980mm
- Hand rail (optional)
- Adjustable rubber feet to compensate for uneven floors
- Rotating head can be set in any desired operator position
- Easily folds for storage, handle and transportation castors included
- 2 year warranty
- 37.0Kg product weight



Nagata BW5158

The remote cable display may be placed on a desk or trolley or attached to the wall. With the optional handrail this scale is ideal for measuring patients with walking aids, wheelchair patients or patients sitting on a stationary chair.

- 300Kg capacity
- 100g graduation
- BMI, Pre Tare, Tare, Hold and Recall functions
- Large easy to read digital display
- Rechargeable battery
- Durable metal construction with non skid surface
- Low angle integrated ramps for easy access
- Large stable platform, 760mm x 800mm (flat portion)
- Product size 1080mm x 990mm x 980mm
- Hand rail (optional)
- Adjustable rubber feet to compensate for uneven floors
- 9 wheelchair weight memories
- Folds easily for storage, handle and transportation castors included
- 2 year warranty
- 37.0Kg product weight



BW5160-M *With optional hand rail as above* **£811.00**
Multifunction wheelchair scale with handrail

BW5160 *Without optional hand rail* **£729.00**
Multifunction wheelchair scale without handrail with separate cable display

BW5158-M *With optional hand rail* **£861.80**
Multifunction wheelchair scale with handrail

BW5158 *Without optional hand rail as above* **£811.00**
Multifunction wheelchair scale without handrail with separate cable display

Nagata BW5156 Long model

This scale allows the weighing of patients on emergency trolleys, transport gurneys, wheelchairs and stationary chairs. The scale features sturdy integrated ramps with an expanding ramp for easy access. The indicator can be rotated up, down, left and right. Optional robust folding handrail allows weighing of wheelchair bound patients, patients with walking aids and patients sitting on a stationary chair.

- 300Kg capacity
- 100g graduation
- BMI, Tare, Hold and Recall functions
- Large easy to read digital display
- Rechargeable battery
- Non skid surface
- Large stable platform, 1200mm x 800mm (flat portion)
- Product size 1780mm x 990mm x 980mm
- Hand rail (optional)
- Adjustable rubber feet to compensate for uneven floors
- Low angle integrated ramps for easy access
- Rotating head can be set in any desired operator position
- Folds away for easy storage, handle and transportation castors included
- 2 year warranty
- 52.0Kg product weight



BW5156-L *With optional hand rail as above* **£1339.00**
Multifunction wheelchair scale with handrail

BW5156LM *Without optional hand rail* **£1279.00**
Multifunction wheelchair scale without handrail

Your local medical supplier is just a phone call away. See cover for full details

Prices shown are exclusive of VAT and delivery

Chair, Bed & House Scales & Height Measures

Nagata BW-3143K Chair Scale

High quality durable chair scale provides ease of use and security for small children, ambulatory elderly, frail and handicapped patients. Lift away armrests hold securely when parked and foldable footrests allow easy access.

- 200Kg capacity
- 100g graduation
- BMI, Tare, Hold and Recall functions
- Large easy to read digital display
- Rechargeable battery
- Large hygienic ABS seat size 480 x 500mm
- Product size 565mm x 840mm x 940mm
- Rear mounted display
- 2 year warranty
- 23.8Kg product weight



Fixed 100mm front wheels and swivelling 100mm rear wheels with brakes

BW3143K Wheelchair scale **£509.00**

Optional 75mm swivelling front and rear wheels and rear wheels with brakes

BW3143A Wheelchair scale **£549.80**

Soehnle 7707 Class III

- 250Kg capacity
- 100g graduation
- Approved to Class III, MPG Class 1
- BMI, Hold and Dialysis function
- Easy to use and sturdy construction
- Backlit LCD with 20mm digit height
- Kgs/Lbs selectable
- Rechargeable battery
- Made in Germany
- Product weight 2Kg
- 200 x 70 x 25mm



7707.37-002 Soehnle 7707 **£657.90**

ADE 601020 Bed Scale

With two independent weighbridges and built in ramps to help easy positioning of the bed.

- 500Kg capacity
- 100g graduation
- 300Kg maximum patient weight
- Selectable Lbs/Kgs display
- BMI, Pre-Tare, Tare and Hold functions
- 25mm LCD display
- Mains and rechargeable battery
- Serial interface for printer or PC connection
- Plug connection to load cell extension lead
- Dimensions 1000 x 450 x 90mm

ADE



M601020 Bed scale **£2900.00**

ADE M600020

- 500Kg capacity
- 100g graduation
- 300Kg maximum patient weight
- Selectable Lbs/Kgs display
- BMI, Pre-Tare, Tare and Hold functions
- 25mm LCD display
- Mains and rechargeable battery
- Serial interface for printer or PC connection
- Weighing shoes with integrated ramps
- Stand included
- 600 x 550 x 920mm

ADE



Four weighing shoes with integrated ramps



M60020 Bed scale **£3360.00**

Your local medical supplier is just a phone call away. See cover for full details

Prices shown are exclusive of VAT and delivery

Scales & Height Measures **Column Scales**

2 – Column Scales – Class III Approved

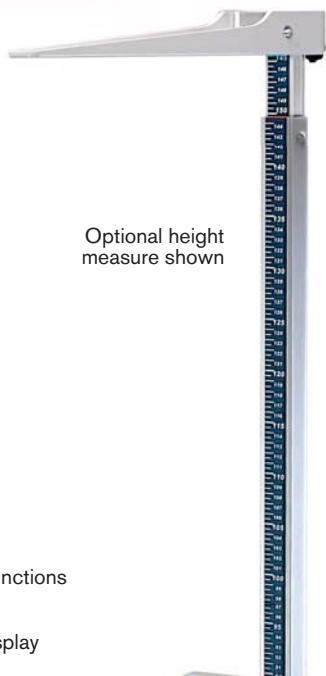

Optional height measure shown

Nagata BW1322

- 200Kg capacity
- 100g graduation
- BMI, Tare, Hold and Recall functions
- Mother and child facility
- Large, easy to read digital display
- Rechargeable battery
- Durable metal construction
- Non skid surface
- Large stable platform, 320mm x 375mm x 95mm high
- Adjustable rubber feet to compensate for uneven floors
- Attached movement castor for easy transportation
- Rotating head can be set in any desired operator position
- 2 year warranty
- 13.2kg product weight
- Height measure can be retrofitted



BW-1322

Nagata Class III column scale

£283.20

HMA

Height Measure, 80-200cm ran

£50.00

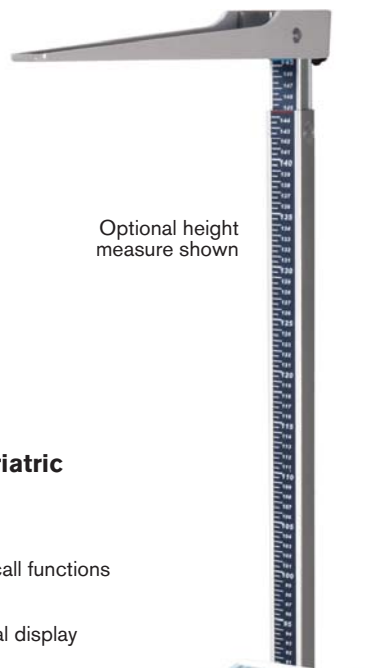

Optional height measure shown

Nagata BW1328 Bariatric

- 300Kg capacity
- 100g graduation
- BMI, Tare, Hold and Recall functions
- Mother and child facility
- Large easy to read digital display
- Rechargeable battery
- Durable metal construction
- Non skid surface
- Large stable platform, 400mm x 450mm x 95mm high
- Adjustable rubber feet to compensate for uneven floors
- Rotating head can be set in any desired operator position
- 2 year warranty
- 16.4kg product weight
- Height measure can be retrofitted



BW-1328

Nagata Class III Bariatric column scale

£455.80

HMA

Height Measure, 80-200cm ran

£50.00

Your local medical supplier is just a phone call away. See cover for full details

Prices shown are exclusive of VAT and delivery

Nagata BW2200 Integra Column Scale with integral height rod

With its integral height rod BW2200 calculates weight, height and BMI in one easy step. Simply step onto scale, raise height rod and BMI is automatically calculated. With the optional printer a hard copy can be kept to determine weight and BMI movement over time.

Robust and stylish the BW series is ideal for any busy gym, sports centre, weight loss clinic and other areas not requiring a Class III approved scale.

20mm high digits for easy reading. Rubber non slip mat and large weighing platform.

- Maximum weight 250Kg
- Graduations 1.0Kg
- Dimensions 320 x 620 x 1275mm
- Platform size 320 x 375 x 90mm
- Product weight 14.7Kg
- Height Rod 110-200cm in 0.1cm graduations



BW2200 £611.00
Nagata Integra column scale with integral height measure

BW2200P £815.00
Nagata Integra column scale with integral height measure and printer

Nagata BW2228 Combi Column scale with side mounted height rod

With an oversize weighing platform and a large 300Kg capacity the BW2228 is ideal for bariatric use. Heavy duty steel structure. Simply raise rod whilst client is being weighed and display will automatically show height, weight and BMI.

- Maximum weight 300Kg
- Graduations 1.0Kg
- Dimensions 400 x 630 x 1210mm
- Platform size 400 x 450 x 95mm
- Product weight 14.7Kg
- Height Rod 110-200cm in 0.1cm graduations



BW2228 £509.00
Nagata Combi Column scale with side mounted height rod

Your local medical supplier is just a phone call away. See cover for full details
Prices shown are exclusive of VAT and delivery

Scales & Height Measures Accessories

Height Rods – Portable Ultrasonic

Soehnle Folding Ultrasonic height measure

Ultrasonic measuring technology, with automatic temperature compensation

- Tilt sensor with error measure indicator to assist correct placement
- Folding sensor reduces space required
- Battery operated for complete mobility
- LCD display with 9.0mm high digits
- Acoustic acknowledgement at end of measurement and reading displayed
- Cm/Ins switchable
- Measuring range 50 – 240cm
- Divisions 10mm
- Dimensions 345 x 92 x 28mm
- Weight 250g



5003.01.001

Soehnle folding ultrasonic height measure

£147.90

ADE 10023

Wall mounted height rod available in cm and cm/ins

- Measuring range 60 – 210cm
- Graduation 1.0mm
- Weight 750g



MZ10023-1

Wall mounted measuring rod in cms only

£60.20

MZ10023-2

Wall mounted measuring rod in cms/ins

£60.20

ADE 10032

Digital wall mounted height measuring rod

- Wall mounted
- Digital readout of height
- Separate display
- Battery powered
- Measuring range 1100mm to 2000mm
- Graduation 1.0mm
- Dimensions 1100 x 90 x 70mm
- Weight approx 1.4Kg



ADE 10020 Ultrasonic height measure

- Compact foldable height measure
- Cms/Ins switchable
- Low battery indication
- 9v battery operation
- Measuring range 50 – 250cm
- Graduation 5.0mm
- Dimensions open 500 x 35mm
- Dimensions closed 340 x 35mm
- Weight 330g approx

Easy handling and storage due to folding mechanism

MZ10020

ADE folding ultrasonic height measure

£80.60



MZ10032

ADE digital wall mounted height measure

£172.40

ADE circumference tape

- Printed on both sides
- Measures circumference and length
- Press button auto rewind
- Circumference lock
- Measurement range 50 – 1500mm
- Graduation 1.0mm
- Dimensions 55 x 80 x 20mm
- Weight 45g



MZ10021

ADE circumference tape

£29.60

ADE Measuring Tape

Roll up tape for wall mounting
Easy to use and space saving
Recess allows convenient readout
Measuring range 0 – 2200mm
Graduation 1.0mm
Dimensions 140 x 35 x 130mm
Weight 180g approx



MZ10017

ADE wall mounted tape measure

£15.30

Your local medical supplier is just a phone call away. See cover for full details

Prices shown are exclusive of VAT and delivery

Baby Measures Scales & Height Measures

Soehnle Digital/Analogue Measure 5005

- Easy to use
- Quick and precise even with restless babies
- LCD display with 16mm digit height
- Battery operated for portability
- Auto off power saver
- Switchable Cms/Ins
- Can be attached to Baby Scale 7725
- Measuring range 35 – 80.1cm
- Divisions 1.0mm
- Dimensions 630 x 290 x 70mm
- Weight 60g



5005.10.001

Soehnle digital and analogue baby measure

£178.50

ADE Measuring Rod

- Extra large tongues
- Soft sliding for easy and comfortable operation
- Measuring range 200 – 1000mm
- Graduation 2.0mm
- Dimensions 910 x 140 x 340mm
- Weight 700g



MZ10028

ADE Measuring Rod

£60.20

ADE Baby Measuring Mat

- Easy to read
- Soft material, perfect for soft babies skin
- Easy to clean hygienic plastic material
- Resistant to soft disinfection fluids
- Cm/Ins reading
- Measuring range 100 – 1000mm
- Graduation 5.0mm
- Dimensions 1260 x 280 x .90mm
- Weight 585g

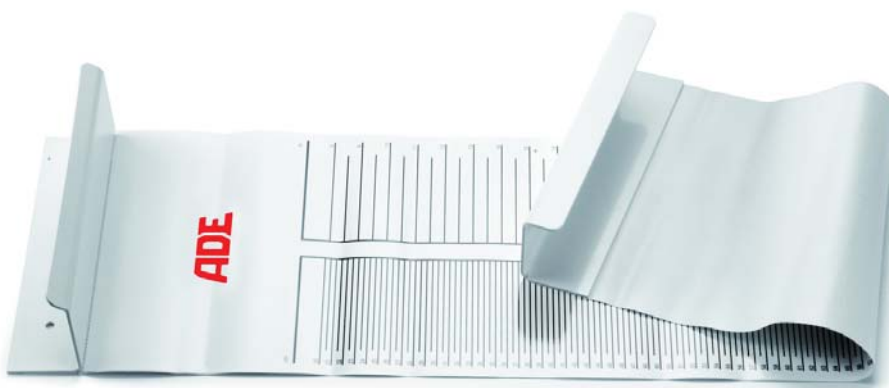

MZ10027

ADE Baby measuring mat

£30.25

Your local medical supplier is just a phone call away. See cover for full details

Prices shown are exclusive of VAT and delivery

Refrigeration Pharmacy Fridges

A range of pharmacy refrigerators and freezers suitable for storing vaccines and medication ensuring excellent temperature control.



FREE DELIVERY TO MAINLAND UK ONLY



Reliable lock for assured safety and peace of mind



Clear visual display of current temperature and set values

Swan 280 Litre Refrigerator

- Generous capacity suitable for the larger surgery
- External Dimensions: 1450h x 600w x 600FTB
- No. of Shelves: 6
- Capacity: 280 litres/9.0cu ft



Model AWR-SW 280 shown

AWR-SW280 Swan 280 Litre Pharmacy Refrigerator **£908.50**

Dometic DS301H and DS601H

- Ideal for storage of temperature critical vaccines etc
- Keeps temperature critical medicines between 2°C and 6°C
- Top mounted digital thermometer
- Lockable

DS301H

- Gross volume: 28 litres
- Weight: 16kgs
- Dimensions: 580 x 422 x 393 mm

DS601H

- Gross volume: 53 litres
- Weight: 18kgs
- Dimensions: 592 x 486 x 494 mm



DS301H 28 litres

£510.00

DS601H 53 litres

£566.50

Your local medical supplier is just a phone call away. See cover for full details
Prices shown are exclusive of VAT and delivery

Swan 135, Swan 160 and Swan 165 Electronic

- Ideal for the vast majority of surgeries these 2 sizes both fit neatly and unobtrusively under existing work surfaces
- The Swan range of Pharmacy Refrigerators provide safe temperature controlled storage for all your vaccines, insulin, other temperature critical pharmaceuticals and laboratory samples
- Excellent build quality and reliability, at a very reasonable cost
- External digital minimum/maximum thermometer
- Adjustable thermostat temperature control
- Temperature deviation alarm
- Internal air circulation
- Frame mounted door lock
- Adjustable wire shelves with nylon coating
- Automatic defrost
- Reversible door
- Manufactured in the UK
- Excellent sales and service network
- Operating range +2°C to +10°C
- 12 month warranty

Additional shelves are available on request



Swan 135

- Ideal intermediary sized pharmacy cabinet with centrally mounted door lock
- Lock mechanism is frame mounted rather than door mounted
- High quality door hinges
- 3 shelves as standard
- External dimensions: 850h x 500w x 600d mm
- Capacity: 135 litres

Swan 160

- External dimensions: 850h x 600w x 600FTB
- No. of shelves: 3
- Capacity: 160 litres/5.25cu ft

Swan 165 Electronic

- Integral flush mounted digital indication of internal temperature
- User definable upper and lower limits
- Optional display of High and Low temperatures achieved
- For further peace of mind an externally mounted battery operated temperature display and alarm module is also fitted should mains power failure occur
- Centrally frame mounted door lock
- 2 adjustable shelves
- Auto de-frost
- Optional glass door
- Capacity: 160 litres/15.25cu ft
- Dimensions: 850h x 600w x 650d



Model AWR-SW160 shown

FREE DELIVERY TO MAINLAND UK ONLY

Please Note

This is just a small selection from our range of chest and cabinet freezers. Please ask for a specialised brochure.

AWR-SW135 - Swan 135	£695.30
External dimensions: 850h x 500w x 600d mm Capacity: 135 litres	
AWR-SW160 - Swan 160	£725.80
External dimensions: 850h x 600w x 600FTB Capacity: 160 litres/5.25cu ft	
AWR-SW165GD	£1370.00
As above, with optional glass door	

Your local medical supplier is just a phone call away. See cover for full details

Prices shown are exclusive of VAT and delivery

Refrigeration Pharmacy Fridges

Portable Refrigeration

WAECO Mobile refrigeration units are designed to protect temperature sensitive goods in transport and are fitted with high performance electronics to ensure that set temperatures are achieved consistently and accurately

A useful range of sizes ensures there is a mobile unit suitable for all applications.

TC-07

- 7 litre gross capacity
- 12v/230v DC/AC
- Temp. Range, cooling down to 5°C (approx 25°C below ambient temperature)
- Weight 3.0kg approx
- Thermostat for temp setting
- Shoulder strap and connection leads supplied



TC-07 Portable Refrigeration 7 litre **£203.00**

TC-14FL

- 14 litre gross capacity
- 12/24v DC and 230v AC
- Temp range, down to +1°C
- 7 stage electronic thermostat with LED display
- Memory function
- Lid with magnetic lock
- Fold away handle
- 3 pin plug



TC-14FL Portable Refrigeration 14 litre **£269.00**

TC-21FL

- 21 litre gross capacity
- 12/24v DC and 230v AC
- Temp range down to +1°C
- 7 stage electronic thermostat with LED display
- Memory function
- Lid with magnetic lock
- Fold away handle



TC-21FL Portable Refrigeration 21 litre **£279.20**

Useful accessories for WAECO coolers

DTTC-05

- Remote display of interior temperature via digital radio waves.
- Shows current temperature at the wheel

DTTC-05 **£303.50**

DTTC-07

- Data logger and software
- USB stick logger, can be used with all fridges



DTTC-07 **£506.50**

Swan VFD Sparkfree -25C Freezers

A comprehensive range of high specification upright freezers equipped with temperature alarms. These models have fixed freezing shelves for even temperature distribution throughout the interior and solid internal storage drawers for easy cataloguing and sample retrieval. All models have exterior temperature control and manual defrosting eliminates the need for any internal heaters.

Options available at additional cost

- 7 day/30 day chart recorder
- Locks (where not already fitted)
- Stainless steel cabinet
- Electronic temperature control
- Digital temperature display
- Racking systems
- Access ports



FREE DELIVERY TO MAINLAND UK ONLY



Please Note

This is just a small selection from our range of chest and cabinet freezers. Please ask for a specialised brochure.

AWR-SWF80 VFD **£685.20**

Capacity: 80 litres, 2.8cu ft
External Dimensions: 630h x 555w x 625FTB
Alarm: Visual High Temp Drawers: 2

AWR-SWF130 VFD **£807.00**

Capacity: 130 litres, 4.6cu ft
External Dimensions: 850h x 555w x 625FTB
Alarm: Visual High Temp Drawers: 4

AWR-SWF230 VFD **£1100.00**

Capacity: 230 litres, 8.2cu ft
External Dimensions: 1450h x 600w x 635FTB
Alarm: Audio/Visual High Temp Drawers: 6

Your local medical supplier is just a phone call away. See cover for full details

Prices shown are exclusive of VAT and delivery

Swan Pharmacy Refrigerators - Heavy Duty

- The range of Swan Heavy Duty Pharmacy Refrigerators provide excellent temperature critical storage, with added features suitable for heavy-duty usage
- High capacity compressor gives superior temperature control and excellent temperature recovery, making it ideal for practices where the unit is opened frequently
- Reinforced hinges and in-door security lock maintain the safety of stored pharmaceuticals
- Ideal for storage of all your vaccines, insulin, other temperature critical pharmaceuticals and laboratory samples
- External digital temperature display
- Available in a range of sizes to fit the requirements of your practice
- Excellent build quality and reliability, at a very reasonable cost
- Adjustable thermostat temperature control
- Internal air circulation
- Adjustable wire shelves with nylon coating
- Automatic defrost
- Reversible door
- Manufactured in the UK
- Excellent sales and service network
- Operating range +2°C to +10°C
- 12 month warranty



Glass door option available on all models



Additional shelves are available on request

FREE DELIVERY TO MAINLAND UK ONLY

Solid Door

AWR-SW250hd £1240.00

Swan Heavy-Duty Pharmacy Refrigerator, 250 litre capacity
Dimensions 1250(h) x 600(w) x 610(d) mm

AWR-SW350hd £1279.00

Swan Heavy-Duty Pharmacy Refrigerator, 350 litre capacity
Dimensions 1640(h) x 600(w) x 610(d) mm

Glass Door

AWR-SW250gd £1450.00

Swan Heavy-Duty Pharmacy Refrigerator, 250 litre capacity
Dimensions 1250(h) x 600(w) x 610(d) mm

AWR-SW350gd £1529.00

Swan Heavy-Duty Pharmacy Refrigerator, 350 litre capacity
Dimensions 1640(h) x 600(w) x 610(d) mm

Your local medical supplier is just a phone call away. See cover for full details

Prices shown are exclusive of VAT and delivery



OPTICLAR VISIONAIR Laryngoscope Systems

Combining modern fibre optic technology and Opticlar Multivoltage LEDs the Opticlar VisionAir range of blades and handles provides the anaesthetist with the very best combination of light and blade design.

The Opticlar VA Mono system incorporates the popular and easy maintenance integral fibre optic bundle into a one piece design. With the fibre optic bundle protected and sealed in position with advanced resins we are able to offer a reassuring 6 year blade warranty against faulty workmanship or materials.

All of our VA Mono blades are to recognised patterns and comply with ISO 7376 Green Standard and are therefore compatible not only with the Opticlar range of handles but also with other manufacturers handles that are Green Standard compliant.



Features of Mono blades

- Free from crevices and other hard to clean areas and with no parts to disassemble cleaning and maintenance is quick and easy
- Resistant to autoclaving at normal cycles so allowing them to follow normal decontamination and sterilisation protocols
- With a 4.5mm overall diameter bundle and over 6500 fibres the blades transmit light to the important blade end in a concentrated, well focussed beam
- Minimise cross infection worries as popular styles and sizes are available in a very cost effective single use format

The Opticlar handle range is comprehensive and innovative.

The Hygena system:

- Combines Opticlar MV LED technology with the latest handle design
- Provides bright white LED light
- Simplifies cleaning and avoids potential infection retained in knurling or cross hatching of the handle body without losing the necessary grip and feel
- Hygena's green credentials stretch further with an impressive continual use time of over 100 hours from just 2 C cells and illumination levels that far exceed Xenon powered systems
- Comprehensive range includes, Stubby, AA, C , C Angled and rechargeable handles and modular handle outer shells.



Your local medical supplier is just a phone call away. See cover for full details

Prices shown are exclusive of VAT and delivery

Laryngoscopes Accident & Emergency

Macintosh Flexi-Blade for difficult intubations



600.015.002M	Size 2 100 x 17mm	£259.00
600.015.003M	Size 3 130 x 18mm	£259.00
600.015.004M	Size 4 160 x 18mm	£259.00
600.015.005M	Size 5 176 x 18mm	£259.00

Macintosh Blades



600.010.000M	Size 0 82 x 9mm	£89.00
600.010.001M	Size 1 93 x 11mm	£89.00
600.010.002M	Size 2 115 x 15mm	£89.00
600.010.003M	Size 3 135 x 15mm	£89.00
600.010.004M	Size 4 155 x 15mm	£89.00
600.010.005M	Size 5 176 x 15mm	£89.00

Miller Blades



600.020.0000M	Size 00 76 x 9.5mm	£89.00
600.020.000M	Size 0 80 x 10.5mm	£89.00
600.020.001M	Size 1 100 x 11.5mm	£89.00
600.020.002M	Size 2 152 x 13mm	£89.00
600.020.003M	Size 3 192 x 13mm	£89.00
600.020.004M	Size 4 207 x 16mm	£89.00

NeoNate Blades



600.050.000M	Size 0 82 x 12mm	£89.00
600.050.001M	Size 1 95 x 13mm	£89.00

Saling New Born and SCBU Blades



Specifically designed for new borns and SCBU the Saling blades due to their very small size feature a miniturised bulb in blade that is only compatible with the Saling handle. Powered by 2 x AA batteries

600.140.000	£376.00
Set - Micro, Narrow, Broad, AA handle	
600.140.001 Micro	£89.00
600.140.002 Narrow	£89.00
600.140.003 Broad	£89.00
600.140.010 AA handle with bulb	£109.00

Wisconsin Blades

600.030.000M	£89.00
Size 0 76 x 9.5mm	
600.030.001M	£89.00
Size 1 102 x 11mm	
600.030.002M	£89.00
Size 2 130 x 16mm	
600.030.003M	£89.00
Size 3 160 x 16mm	

Your local medical supplier is just a phone call away. See cover for full details

Prices shown are exclusive of VAT and delivery



High performance LED providing bright white light. LED life in excess of 20,000 hours. LED capsule is easy to remove without the need for tools and whole handle is autoclaveable at normal cycle times and temperatures. The Hygena handle design provides excellent comfortable grip yet is much easier to clean than the traditional knurled finish. The traditional knurled finish is available for those units who wish to retain this type of handle.

Opticlar VA C cell handle (1)

600.080.002	£105.00
Opticlar VA LED C cell handle with Hygena grip	
600.080.002K	£105.00
Opticlar VA LED C cell handle with knurled grip	

Opticlar VA AA slimline handle (2)

Ideal for use with smaller blade sizes or for those anaesthetists with smaller hands

600.080.000	£105.00
Opticlar VA LED AA cell handle with Hygena grip	
600.080.000K	£105.00
Opticlar VA LED AA cell handle with knurled grip	

Opticlar VA Stubby AA handle (3)

Ideal for use in confined situations where patient anatomy restricts the use of a full size handle

600.080.003	£125.00
Opticlar VA LED Stubby AA handle with Hygena grip	

Opticlar VA C cell Polio handle (4)

Cost effective solution to purchasing Polio blades, acute angled connector enables all blades to be used with restrictive anatomy patients

600.080.004	£139.00
Opticlar VA LED C cell Polio handle with Hygena grip	

Opticlar VA Rechargeable handle. Compatible with Opticlar and Heine chargers (5)

600.090.010	£165.00
Opticlar Rechargeable handle with LED illumination. Hygena grip	
600.090.010H	£165.00
Opticlar Rechargeable handle with LED illumination. Knurled grip	

Opticlar Chargers. Single port and twin port systems (6 & 7)

100.000.123/1	£139.00
Opticlar twin port desk recharger with power lead and plug (7)	
100.000.123/2	£98.50
Opticlar single port desk recharger with power lead and plug (6)	

Rechargeable Cells

HRC382	£43.50
Rechargeable cell for Opticlar and Heine handles	



Disposable Laryngoscope Blades

All Opticlar VA disposable blades have the following features:

1. Low profile heels for easier visualisation and less risk of dental damage
2. Acrylic light core with 'Glare Guard' to minimise light loss and reduce dazzle
3. Minimal light core intrusion into blade reducing dazzle. Light exits where it should, at the end of the blade and not along the blade. This ensures excellent light transmission into the laryngopharynx without distracting dazzle from the light core
4. Solidly mounted heel and blade assemble to minimise possible blade breakage and conventional locating ball bearings
5. Smooth blade design that mimics reusable blades and ensures light outputs at correct position
6. Economical price
7. Popular sizes and blade designs
8. ISO 7376 Green Standard compatible

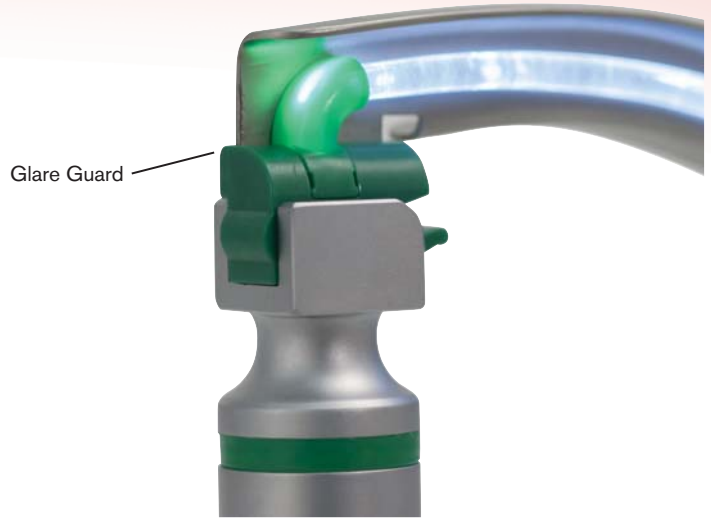

Macintosh Single Use

600.010.002SU	£45.00
Opticlar SU Disposable Mac blade - Size 2 - 100x17 - Pack of 10	
600.010.003SU	£45.00
Opticlar SU Disposable Mac blade - Size 3 - 130x18 - Pack of 10	
600.010.004SU	£45.00
Opticlar SU Disposable Mac blade - Size 4 - 160x18 - Pack of 10	

Macintosh Flexi-Blades Single Use

600.015.002SU	£205.00
Opticlar SU Disp Mac-Flexi blade - Size 2 - 100x17 - Pack of 5	
600.015.003SU	£205.00
Opticlar SU Disp Mac-Flexi blade - Size 3 - 130x18 - Pack of 5	
600.015.004SU	£205.00
Opticlar SU Disp Mac-Flexi blade - Size 4 - 160x18 - Pack of 5	
600.015.005SU	£205.00
Opticlar SU Disp Mac-Flexi blade - Size 5 - 176x18 - Pack of 5	

Miller Blades Single Use

600.020.0000SU	£45.00
Opticlar SU Disp Miller blade - Size 00 - 76x9.5 - Pack of 10	
600.020.000SU	£45.00
Opticlar SU Disp Miller blade - Size 0 - 79x12 - Pack of 10	
600.020.001SU	£45.00
Opticlar SU Disp Miller blade - Size 1 - 105x13 - Pack of 10	

Your local medical supplier is just a phone call away. See cover for full details
 Prices shown are exclusive of VAT and delivery

Accident & Emergency Aspirators

Guardian Mini Suction Pump

- Simple mini aspiration unit, for domestic use
- Ideal for tracheotomy patients, and mucus aspiration
- 1000cc suction bottle with one way valve cap
- Includes anti-bacterial filter, as required by regulations
- White/Blue ABS plastic casing, with storage space for accessories
- Vacuum gauge indicates current suction level
- Includes bottle, tubing, 10 suction catheters, and instructions
- 30ml overflow bottle
- Suction control from 0–65mm Hg/Ø to -Ø.7 bar
- Flowrate >11 Litres/MIN
- Weight 2.65kgs Height 170mm Width 220mm Depth 170mm



200.10.030 Guardian Mini Suction Pump **£101.00**

Spares and Accessories

200.10.050/7	Anti-bacterial filter	£9.20
200.10.000/10	Tracheostomy kit	£24.50
200.10.020	Pack of 10 suction catheters, 16fg / central & side eye	£6.20
200.10.000/4	Suction control valve / connector	£2.60
200.10.050/3	Silicone suction tubing, 3m length	£18.40
200.10.000/5	300cc Aspiration bottle	£24.50
200.10.010B	Aspiration bottle with non-return valve	£24.50

AW Port A Suction Rechargeable Aspirator



- Compact rechargeable portable aspirator
- Internal rechargeable battery, charged from mains or 12v vehicle
- Choose from:
 - Port A Suction Pro - with reusable/autoclaveable 1000cc bottle
 - Port A Suction Pro D - with 2000cc bottle, complete with 5 disposable liners
- Flowrate >20 Litres/MIN
- Suction control from 0–65mm Hg/Ø to -Ø.8 bar
- Includes anti-bacterial filter, as required by regulations
- Vacuum gauge indicates current suction level
- Includes connecting tubing, 10 suction catheters, 12v car lighter lead and mains transformer
- Suitable for medical environments where mains power is unavailable
- 30 minutes continuous use with 14-16 hours total charging time
- Weight 5.8kgs Height 240mm Width 370mm Depth 100mm

200.10.052 **£406.00**
Guardian Port A Suction with reuseable autoclaveable bottle

200.10.052D **£416.20**
Guardian Port A Suction with disposable liner system

200.10.052/4 Carry Case **£35.70**

Spares and Accessories

200.10.050/8	1 litre suction bottle with cap, autoclaveable	£83.70
200.10.050/3	Silicone suction tubing, 3m length	£18.40
200.10.000/4	Suction control valve / connector	£2.60
200.10.050/6	Anti-bacterial filter (pre Oct 2002)	£9.00
200.10.050/7	Anti-bacterial filter (from Oct 2002)	£9.20
200.10.020	Pack of 10 suction catheters, 16fg / central & side eye	£6.20
200.10.052/2	Replacement power transformer	£59.00
4035/1	Single disposable inner bag with lid	£7.80
4035/50	Box of 50 disposable inner bags with lids	£355.30
4036	2 litre autoclaveable bottle for use with disposable bags	£65.30

Your local medical supplier is just a phone call away. See cover for full details

Prices shown are exclusive of VAT and delivery

AW Suction Pro Professional Aspirator

- Twin piston compressor, smooth and reliable
- Choose from:
 - Suction Pro - with reusable/autoclaveable 1000cc bottle
 - Suction ProD - with 2000cc bottle, complete with 5 disposable liners
- Suction control from 0–65mm Hg (-0.8 bar)
- Robust construction
- Anti-bacterial filter
- Carrying handle
- Continuous use rated
- 22 litres per minute flow rate
- Dimensions; HWD 200mm, 280mm, 210mm



Spares and Accessories

200.10.050/3		£18.40
3 metres of silicone tubing to cut to length required		
200.10.050/4		£2.60
Suction control valve to fit between catheter and tubing		
200.10.050/5	Replacement power lead	£14.30
200.10.050/6	Anti-bacterial filter to fit between tubing	£9.00
200.10.050/7	Anti-bacterial filter, push fit into machine	£9.20
200.10.050/9	Anti-bacterial filters, for post Oct 2002 units	£9.00
200.10.050/8	Autoclaveable 1000cc bottle with cap	£83.70
4035/1	Single disposable inner bag with lid	£7.80
4035/50	Box of 50 disposable inner bags with lids	£355.30
4036		£65.30
2 litre autoclaveable bottle for use with disposable bags		

200.10.050		£289.50
Guardian Suction Pro with reusable autoclaveable bottle		
200.10.050D		£299.50
Guardian Suction Pro with disposable inner liner and bottle (supplied with 2 liners)		

Your local medical supplier is just a phone call away. See cover for full details

Prices shown are exclusive of VAT and delivery

Accident & Emergency Aspirators

DeVilbiss Vacuaide 7305

- Ideal home use suction unit that also meets the stringent ISO standards for emergency transport suction.
- Model 7305 is small and lightweight with a high performance capability and is mains and rechargeable.
- Unique switch mode on both models allowing AC operation with voltages from 110v to 240v
- High performance, 550mm Hg suction and up to 27 litres per minute flow rate
- Small, lightweight and truly portable
- Integrated bacterial filter
- Automatic float shut off
- Standard 800cc disposable bottle
- Rechargeable battery with up to 60 minute run time
- Automatically recharges when connected to mains
- Canvas carry case
- 12v DC capability for vehicle recharging



Specifications

Dimensions	23 x 18 x 20cm
Weight	Rechargeable 2.9kg
Vacuum range	80 – 550mm Hg
Flow range	0 – 27 litres per minute
Voltages	User determined from 110 to 240v
Internal battery life	Up to 60 minutes

VacuAide 7305 PU	£329.90
Rechargeable unit with 800cc disposable bottle	

Accessories	
200.10.020	£6.20
Suction catheter, 50cm long, pack of 10, sterile	
VacuAide bottle	£24.99
800cc disposable bottle	
VacuAide filters	£59.00
Pack of 12 replacement filters	

Your local medical supplier is just a phone call away. See cover for full details

Prices shown are exclusive of VAT and delivery

Aspira Plus Aspirator



The new model ASPIRA is a professional surgical aspirator, for medical and surgical use. Suitable for use in health care facilities such as hospitals, for home care and for pharyngeal suctioning. In compliance with ISO 10079-1 standard. The declared flow has been tested and validated by TÜV Rheinland.

- Case built with top quality plastics, ensuring robustness during heavy duty applications
- Reduced weight for easier transport with the integrated handle
- Bottle holder can be placed on the right or on the left side of the device, housing a one-litre graduated PC bottle
- PC bottle and silicone connection tubes can be sterilised for optimum hygiene
- Fits a hydrophobic antibacterial high efficiency filter
- An additional bottle and holder (to be supplied separately) can be applied to the unit allowing the aspiration a bigger volume of secretions
- Patented ASPICOMFORT system allows fine control of the suction level
- Vacuum regulator knob permits to adjust the vacuum level shown on the gauge without impairing the flow ensuring the optimum comfort to the patient during treatment
- Switch is protected against the penetration of liquids by means of a proper cover
- Pump is connected directly to the external housing to prevent secretions accidentally spilling inside reducing the possibility of condensation or incorrect suctioning performed without filter

Special Features

- Adjustable vacuum level
- Silent
- Bottle holder
- Sterilisable bottle and tubes
- Heavy duty
- Real flow 13.5 LPM for the Single Pump model
- Real flow 20 LPM for the Double Pump model
- Available with disposable liner system

200.10.060	Aspira Plus Aspirator with double pump & reusable autoclaveable bottle	£270.00
200.10.065	As above single pump	£235.00
200.10.060D	Aspira Plus Aspirator with double pump, bottle suitable for disposable liners - 2 liners included	£270.00
200.10.065D	As above single pump	£235.00

Your local medical supplier is just a phone call away. See cover for full details

Prices shown are exclusive of VAT and delivery

Accident & Emergency Monitoring

Guardian G-60D Pulse Oximeter

With the Guardian G-60D, SpO₂ saturation levels, pulse, pulse waveform and pulse bar can be viewed together on the LED colour display. The control graphics are easy to understand and follow, with simple menus for settings such as alarm levels, pulse sound and data download.

The G-60D allows the user to carry out spot-check monitoring of the patient within seconds and long-term monitoring is possible (up to 24 hours) with data downloadable to the PC for review – PC 'Green-Heart' software and USB cable are included as standard.

The data review function on the Guardian G-60D means you can study long-term trend graphs for pulse and SpO₂ readings. Any readings outside of the normal range are colour-indicated, so you can see any events at a glance.

Key features of the Guardian G-60D:

- Excellent visual display, with all features and parameters easy to see and understand (OLED)
- Audible and visual alarms with dual alarm levels and limits adjustment for both SpO₂ and pulse
- BCI-compatible probe
- PC link software Green-Heart and cable included as standard:
 - Download and review stored results
 - View SpO₂ and pulse in real-time on your PC screen
 - USB cable included

Adjustable screen brightness

- Powered by 2 x AA Alkaline batteries (not included)



Technical specifications:

Internal memory:	up to 24 hours continuous
Pulse accuracy:	+/- 2bpm / +/- 2%
SpO ₂ accuracy:	70% tp 100% = +/- 2%; below 70% unspecified
Measuring range:	0% to 100%
Dimensions:	110 x 60 x 23 mm
Weight:	180g (approx. inc. batteries)

G-60D	Guardian G-60D Pulse Oximeter	£239.00
BCI 3026	Finger Switch for neonates	£59.00
BCI 3051	Adult finger probe – spare	£27.80
BCI 3403	Finger sensor for paediatrics and infants	£41.00



Guardian Pro-Line G-60B Pulse Oximeter

The Guardian G-60B pulse oximeter provides a clear, continuous display of pulse, pulse waveform and saturation levels on the bright, full-colour TFT display. The G-60B is compact at just 46 x 88 x 23mm. The easy to follow menu systems allow functions and parameters to be selected quickly and easily and the device can be readied for use in seconds. Key features of the G-60B include:

- Stores up to 24 hours results in the internal memory, for download to PC
- Audio and visual alarms can be set
- Dual aspect display – switch between horizontal or vertical to give the best working view of results
- Adjustable brightness control
- Internal li-polymer battery, rechargeable from mains or USB
- Supplied with BCI-compatible adult finger probe
- Includes PC software for the retrieval and review of stored data and real-time display of pulse and SpO₂ on the PC screen

G-60B	Guardian Pro-Line G-60B Pulse Oximeter	£239.00
--------------	--	----------------

Your local medical supplier is just a phone call away. See cover for full details

Prices shown are exclusive of VAT and delivery

Guardian 50C

- Compact finger reading Pulse Oximeter
- Organic LCD for optimum display clarity showing SpO2, pulse rate and pulse bar
- 2 x AAA batteries
- Lanyard supplied



Measuring range
 SPO2 – 35 to 99%
 PR - 30 to 245 BPM
 PR bargraph showing strength

Resolution
 +/- 1% for Spo2
 +/- 1 BPM for pulse rate

Accuracy
 SpO2
 70%-99% +/- 2%
 70% - 80% +/- 3%

Weight
 Approx 50g including batteries

Dimensions
 58 x 32 x 34mm

Battery life
 Circa 30 hours continuous measurement

Low voltage warning
 Auto off

G-50C

Compact finger reading Pulse Oximeter

£64.00

Guardian 50D

- Pulse oximeter with 6 display modes:
 - Right handed with pulse wave
 - Right handed with pulse line
 - Right handed with pulse bar
 - Left handed with pulse bar
 - Vertical reading with pulse bar
 - Inverted vertical reading with pulse bar
- Ideal for ambidextrous use
- Unique multi display compact finger reading
- Organic LCD for optimum display clarity showing SpO2, pulse rate and pulse bar
- 2 x AAA batteries
- Lanyard supplied



Measuring range
 SPO2 – 35 to 99%
 PR - 30 to 245 BPM
 PR bargraph showing strength

Resolution
 +/- 1% for Spo2
 +/- 1 BPM for pulse rate

Accuracy
 SpO2
 80%-99% +/- 2%
 70% - 80% +/- 3%

Weight
 Approx 50g including batteries

Dimensions
 58 x 32 x 34mm

Battery life
 Circa 30 hours continuous measurement

Low voltage warning
 1 year warranty

G-50D

Compact finger reading Pulse Oximeter

£64.00

Guardian Pro-Line G-50F Pulse Oximeter

Guardian G-50F Pulse Oximeter, with OLED full-colour display, is a compact SpO2 monitor for spot-check testing or long-term monitoring over a 24 hour period. G-50F is simple to operate with clear on-screen function control menus. This affordable SpO2 monitor includes many features that you would normally expect on more expensive devices.



- Adjustable alarm function, audible and visual
- Wrist-worn with fully adjustable strap
- Internal memory for up to 24 hours recording
- PC software with dual function included:
 - Real-time on-screen display
 - Download stored data for review and print
 - USB connection to PC
- Comfortable BCI-compatible adult finger probe
- Mains or USB rechargeable internal lithium battery

G-50F Guardian Pro-Line G-50F Pulse Oximeter

£329.90

Your local medical supplier is just a phone call away. See cover for full details

Prices shown are exclusive of VAT and delivery

Accident & Emergency Oxygen Masks & Cannula

Oxygen Mask (Medium concentration)

- Flexible and comfortable oxygen mask designed for convenient oxygen therapy
- Mask moulded from non toxic medical grade PVC
- Adjustable strap for proper positioning of mask
- Swivel connector
- 210cm (7ft) multichannel tube
- Funnel connectors
- Individually packed
- Adult and Child versions
- Master box of 50



GS2020/0 £1.50

Adult medium concentration oxygen mask

GS2020/1 £1.50

Child medium concentration oxygen mask

GS2020/0/50 £58.70 (£1.17 ea)

Master box of 50 Adult medium concentration oxygen masks

GS2020/1/50 £58.70 (£1.17 ea)

Master box of 50 Child medium concentration oxygen masks

Oxygen Cannula



- Designed for easy application and efficient oxygen administration
- Sliding collar for precise fit
- Twin prongs fit comfortably into the nasal passages
- Universal funnel connector
- Manufactured from soft, lightweight non toxic clear PVC
- Multichannel tube ensures continuous supply of oxygen even if tube is accidentally kinked
- Non Sterile
- 210cm (7ft) length

GS2016/0 Adult oxygen cannula £1.00

GS2016/1 Child oxygen cannula £1.00

GS2016/2 Infant oxygen cannula £1.00

GS2016/0/100 £82.00 (£0.82 ea)

Adult oxygen cannula, box of 100

GS2016/1/100 £82.00 (£0.82 ea)

Child oxygen cannula, box of 100

GS2016/2/100 £82.00 (£0.82 ea)

Infant oxygen cannula, box of 100

Oxygen Mask (Variable Venturi System)



- Provides accurate concentrations of oxygen
- Transparent mask with soft anatomical form and easily adjustable strap
- Rotating connector selects according to set flow rates and percentage concentration required
- Flow Rate 6 litres per minute
 - 35%
 - 40%
 - 60%
- Flow Rate 3 litres per minute
 - 24%
 - 26%
 - 28%
 - 31%

- Unique spring loaded mechanism locks prescribed concentration level in place ensuring safety and correct oxygen concentrations

- 210cm (7ft) multichannel tube
- Non Sterile individually packed
- Master box of 50
- Adult and child versions

GS2038/0/50 £94.10 (£1.88 ea)

Master box of 50 Adult size variable concentration oxygen masks

GS2038/1/50 £94.10 (£1.88 ea)

Master box of 50 Child size variable concentration oxygen masks

Your local medical supplier is just a phone call away. See cover for full details

Prices shown are exclusive of VAT and delivery

Eye Irrigation Accident & Emergency

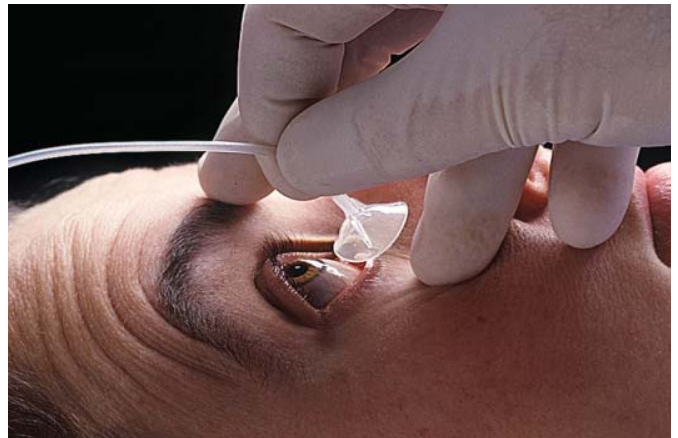
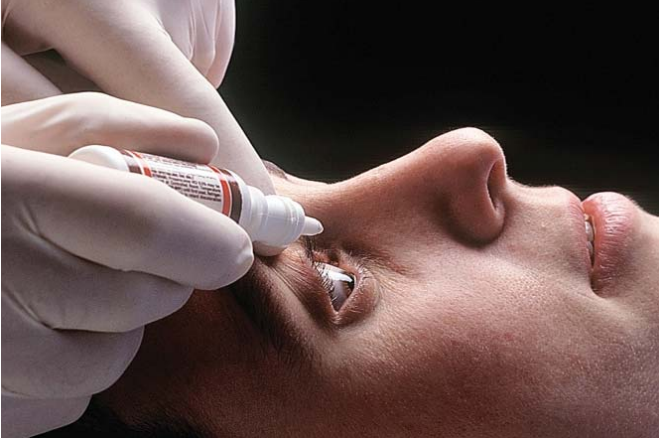

The Morgan Lens

Sight - one of the most precious of faculties.

When an eye emergency happens it can be catastrophic to use inappropriate lavage procedures. That's why Morgan Lens - developed by a practising ophthalmologist - was designed to be up and running within 20 seconds. Not only save sight but save time and money.

- Patented and field tested, the lens attaches to solutions of your choice - saving time and money by freeing up valuable staff to attend to other duties
- The Morgan Lens quickly, effectively and easily irrigates all regions of the eye and inner eyelid
- Using the Morgan Lens dramatically lessens patient discomfort, as the eye naturally closes over the lens. With conventional irrigation methods the eye has to be held open whilst irrigation occurs; for a traumatised eye this can be extremely disturbing and painful

- To make use even easier, an optional delivery set is available for simultaneous irrigation of BOTH eyes
- To further minimise patient discomfort the optional Medi-Duct can be utilised to wick away the irrigating solution from the patient for easy collection, examination and disposal

For a comprehensive brochure and Free CD-Rom please ask

MT2000 **£169.20 per box**
Box of 12 individual sterile Morgan Lenses

MT202 **£33.70 per box**
Box of 6 delivery sets

MT63 **£95.90 per box**
Box of 12 individual Medi-Ducts

Your local medical supplier is just a phone call away. See cover for full details

Prices shown are exclusive of VAT and delivery

Accident & Emergency Tourniquets

Guardian Tourniquets

A cost effective range of latex free tourniquets with Velcro fittings.

Available in 3 sizes:

- **Small** – overall length 24.5cm, for limb diameters 3 - 7cm
- **Medium** – overall length 34.5cm, for limb diameters 6cm to 12cm
- **Large** – overall length 37cm, for limb diameters 6cm to 15cm

P-341	Guardian small latex free tourniquet	£2.90
P-340	Guardian medium latex free tourniquet	£2.90
P-342	Guardian large latex free tourniquet	£2.90



Prameta 906 Tourniquet



- Open ended design for easy application and removal
- Autoclavable at 120c and 1 bar pressure
- Cost effective
- Purple strap with pink clasp and buckle

93.02.050	Prameta model 906 Tourniquet	£10.80
------------------	------------------------------	---------------

Guardian 'Quick Lok' Tourniquet



- Latex free tourniquet with locking clasp

93.20.350	Guardian Quick Lok latex free tourniquet	£5.10
------------------	--	--------------

AW Velket Velcro Tourniquet

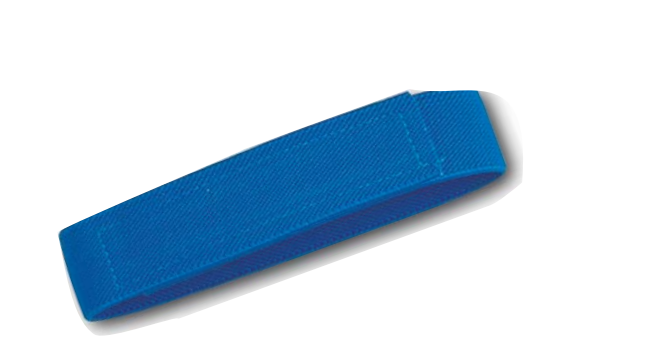

- Latex free elasticated tourniquet
- Universal size
- Double stitched for durability

93.01.000	AW Velket Velcro Tourniquet	£3.05
------------------	-----------------------------	--------------

AW Pull-tight Elasticated Tourniquet



- Finely woven green elasticated strap
- Quick pressure release control
- Very high quality at moderate cost
- Latex free

93.01.050	AW Pull-tight Elasticated Tourniquet	£5.05
------------------	--------------------------------------	--------------

Your local medical supplier is just a phone call away. See cover for full details
Prices shown are exclusive of VAT and delivery

Prameta Grey Tourniquet

- Finely woven strap helps protect the patients skin
- Specially designed alloy buckle allows precise back pressure
- Easy to clean and fully autoclavable
- Latex free



93.05.000 Prameta Grey Tourniquet	£26.30
93.10.000 Spare strap for Prameta Grey Tourniquet	£10.20

Prameta Orange Injection Tourniquet

- "Fixing Bridge" holds vein for injection
- Increases flow and volume through vein, allows easier puncturing
- Both hands are free for injecting
- Blood can be taken without loss in pressure
- Fully autoclavable
- Latex free



93.06.050 Prameta Orange Injection Tourniquet	£38.30
93.14.000 Spare strap for Prameta Orange Tourniquet	£21.50

Disposable Single Use Tourniquet

- Size: 35cm long, 2cm wide
- Simple tear off tourniquet
- Box of 25
- Latex free



93.50.000 Disposable Single Use Tourniquet -	
Pack of 10	£2.50
Pack of 100	£19.00
Pack of 250	£41.50
Pack of 500	£79.00
Pack of 1000	£149.00

Prameta Green Tourniquet

- Latex and cotton weave flexible strap, gentle on patients skin and hair
- Open ended design, for instant quick-release
- Alloy buckle
- Easy to clean and fully autoclavable



93.06.000 Prameta Green Tourniquet	£35.20
93.11.000 Spare strap for Prameta Green Tourniquet	£12.80

Prameta Red Emergency Tourniquet

- 50mm wide-band compression tourniquet
- Stops traumatic bleeding of head and extremities
- Compression plate and lock manufactured from ABS plastic
- Integral clock indicates tourniquet application time
- Easy to clean and fully autoclavable



93.07.000 Prameta Red Emergency Tourniquet	£50.90
93.12.000 Spare strap for Prameta Red Tourniquet. Latex free	£25.00

Guardian Disposable Tourniquets, Type 1



- Disposable version of the popular Velket tourniquet
- Ideal for busy Accident and emergency departments
- Latex free
- Velcro fastening
- Open ended design
- Elasticated strap 25mm x 34cm
- Supplied in packs of 10 units

93.60.000 Guardian Disposable Tourniquet blue 34.5cm long	
Pack of 10	£7.50
Pack of 100	£65.00

Your local medical supplier is just a phone call away. See cover for full details

Prices shown are exclusive of VAT and delivery

Accident & Emergency Defibrillators

ZOLL Defibrillators

First defibrillator designed for profession responders with instantaneous feedback on CPR chest compressions. ZOLLs unique real time feedback mechanism, including an adaptive metronome and screen display, helps rescuers achieve optimum rate and depth compression levels through audible and visual prompts.

ZOLL defibrillators are industry leaders in water and dust ingress protection, achieving a rating of IP55 – suitable for dusty environments and marine use. Full details are available on request.

CPR-D Padz – a one piece pre-connected electrode with CPR feedback. The central pressure pad is quickly located over the sternum, automatically locating the defib pad's. The AED then monitors the patient's ECG whilst giving instructions for manual CPR. During chest compression the device gives feedback on correct pressure and rate of compression.

ZOLL®

Advancing Resuscitation. Today.®

real **CPR** help®

ZOLL AED Pro



ZOLL AED Pro

- ECG monitoring via 3 lead cable
- High resolution display
- Memory capacity without audio recording, 7 hours of ECG data
- Unlimited data storage via optional USB key
- Charge time less than 10 seconds with fully charged battery
- Auto analyse
- Audible voice prompts
- Choice of rechargeable sealed lead acid or disposable lithium manganese battery
- Size 7.6cm x 23.5cm x 23.9cm
- Weight 2.9kg

902102	ZOLL AED Pro Defibrillator	£2650.25
8900-0800-01	Spare CPR-D Padz, single, Adult (5 year shelf life)	£87.80
8900-0810-01	Spare Pedi-Padz, Child (2 year shelf life)	£60.20

Your local medical supplier is just a phone call away. See cover for full details

Prices shown are exclusive of VAT and delivery

ZOLL defibrillators are industry leaders in water and dust ingress protection, achieving a rating of IP55 – suitable for dusty environments and marine use. Full details are available on request.

ZOLL®

Advancing Resuscitation. Today.®



real CPR help

ZOLL AED Plus

By following every link in the chain of survival the chances of a victim surviving a sudden cardiac arrest increases. Every step helps saves life. Whilst ordinary AED's defibrillate the AED plus from ZOLL focuses on the chain of survival and supports effective CPR.

- Unique graphical interface helps rescuers every step of the way
- Lights indicate proper action sequence
- Texts and voice prompts
- Long shelf life pads
- Only a one piece, pre connected electrode pad to place
- Paediatric pads for children up to 8 years old
- Instantaneous CPR feedback
- Helps rescuers to achieve correct rate and depth of compression
- Inexpensive consumer batteries
- Advanced Rectilinear Biphasic waveform



201000	ZOLL AED PLUS Defibrillator	£1295.25
8900-0800-01	Spare CPR-D Padz, single, Adult (5 year shelf life)	£87.80
8900-0810-01	Spare Pedi-Padz, Child (2 year shelf life)	£60.20
8000-0809-01	Wall bracket	£150.00



Your local medical supplier is just a phone call away. See cover for full details
 Prices shown are exclusive of VAT and delivery

Accident & Emergency Resuscitators

Guardian Resuscitation Kit

- Choice of either Reusable Silicon bag or Disposable PVC bag
- Adult face mask
- Disposable laryngoscope blades, sizes 1,2,3 and 4
- Laryngoscope handle
- 3 Guedel airways
- Tuff Cut scissors
- Tourniquet

150.36.000D	£98.00
Disposable PVC resuscitation kit with above accessories	

150.36.000R	£139.80
Reusable Silicon resuscitation kit with above accessories	



222

Disposable Guardian Resuscitators

- Single use only
- High quality PVC
- Adult, child and infant sizes (6 years plus)
- Pressure relief valve
- Latex free
- Set contains resuscitation bag, face mask and oxygen reservoir



GUARDIAN[™]
EMERGENCY & RESUSCITATION

150.32.000AW	£13.30
Guardian adult resuscitator, PVC (age 6 years up)	

150.32.010	£13.30
AW Guardian child resuscitator, PVC	

150.32.020	£13.30
AW Guardian infant resuscitator, PVC	

Your local medical supplier is just a phone call away. See cover for full details
Prices shown are exclusive of VAT and delivery

AW Guardian Pocket Resuscitation Mask

- Compact resuscitation mask in hard-shell pocket case, with strap
- Effective and comfortable air cushion seal
- Tube from filter to rescuer ensures safer and simpler resuscitation
- Head-strap included



150.15.000 AW Guardian Pocket Resuscitation Mask £7.20

Guardian Resuscitators

- Silicon rubber resuscitation bags, autoclaveable and reusable
- Adult, child and infant sizes (6 years plus)
- Pressure relief valve
- Economically priced
- Set contains resuscitation bag, face mask and oxygen reservoir
- Latex free



150.36.010	Adult resuscitation kit	£61.20
150.36.020	Child resuscitation kit	£61.20
150.36.030	Infant resuscitation kit	£61.20

Your local medical supplier is just a phone call away. See cover for full details

Prices shown are exclusive of VAT and delivery

Accident & Emergency **General**

AW Tough Cut Scissors

- Universal tough cut scissor
- Serrated blades cut through most materials
- Ideal for emergency situations, e.g. Cutting through seatbelts
- Autoclavable



J.100.20 AW Tough Cut Scissors **£3.60**

J.100.20DISP Disposable Scissors **£1.50**

AW Guardian Canvas Paramedic Pouch



- Blue/black canvas pouch with 4 individual compartments
- Clip fastening belt loop
- Velcro front cover
 - Available with contents, including:-
 - Tough Cut Scissors
 - 5" Blunt/Sharp Scissors
 - Spencer Wells Artery Forceps 5"
 - T.O.E. Dissecting Forcep 6"
 - Disposable pen torch

5.01.313 **£7.10**

AW Guardian Canvas Paramedic Pouch, without contents

5.01.315 **£22.40**

AW Guardian Canvas Paramedic Pouch, including contents

AW Guardian Leather Paramedic Pouch

- Tough leather instrument pouch with 5 individual instrument compartments
- Clip fastening cover and twin belt clips
- Loop for AA Mag Lite
- Available with contents, including:-
 - Tough Cut Scissors
 - Spencer Wells Artery Forceps 5"
 - 5" Blunt/Sharp Scissors
 - T.O.E. Dissecting Forceps 6"
 - Re-usable pen torch



5.01.111 **£14.30**

AW Guardian Leather Paramedic Pouch, without contents

5.01.115 **£25.50**

AW Guardian Leather Paramedic Pouch, including contents



AW Guardian Inflatable Splints

- Tough inflatable splints for instant inarticulation of legs and arms
- Hard wearing with reinforced seam welds
- Zip fastening
- Inflation tube with twist-closure
- Just wrap around, zip up and inflate
- Choice of half leg (or child leg), full leg, half arm (or child arm) and full arm



150.80.000 AW Guardian Inflatable Splint, half leg **£17.40**

150.82.000 AW Guardian Inflatable Splint, full leg **£19.40**

150.84.000 AW Guardian Inflatable Splint, half arm **£17.40**

150.86.000 AW Guardian Inflatable Splint, full arm **£17.40**

150.88.000 AW Guardian Inflatable Splint, foot and ankle **£17.40**

150.90.000 AW Guardian Inflatable Splint, hand and wrist **£17.40**

150.92.000 Set of 6 Guardian Inflatable Splints (1 of each) **£96.90**

Your local medical supplier is just a phone call away. See cover for full details

Prices shown are exclusive of VAT and delivery

Disposable Guardian Guedel Airways



▪ Anatomically correct design	200.50.070 Green	90mm length	Size 2	£7.00 per pack of 10
▪ Atraumatic soft rounded design	200.50.080 Yellow	100mm length	Size 3	£7.00 per pack of 10
▪ Bite block provides access for suction catheters	200.50.090 Red	110mm length	Size 4	£7.00 per pack of 10
▪ Flexible to ensure dental protection	200.50.100 Orange	120mm length	Size 5	£7.00 per pack of 10
▪ Colour coded	200.50.030 Trans	40mm length	Size 000	£7.00 per pack of 10
▪ Single patient use	200.50.040 Blue	50mm length	Size 00	£7.00 per pack of 10
▪ Sterile	200.50.050 Black	60mm length	Size 0	£7.00 per pack of 10
	200.50.060 White	70mm length	Size 1	£7.00 per pack of 10

Bulk purchase discounts available

Guardian Key fob and face mask



- Latex free
- Compact size
- Provides protection to both rescuer and victim
- One way valve
- Simple and economic to use

150.20.000	£2.40
Guardian Key fob and face mask	

Guardian HandiVac Hand Operated Emergency Aspirator

- Compact emergency suction unit
- Powerful vacuum for speedy operation
- Replaceable Child/Adult aspirate vessel
- 1 suction catheter included as standard



160.55.000	Guardian HandiVac Emergency Aspirator with bottle and hard/soft catheter	£60.70
160.55.000/1	Replacement suction bottle (without catheter)	£9.20
160.55.000/2	Replacement soft catheter	£1.60
160.55.000/3	Replacement hard catheter	£1.60

Training Face Shields with barrier filter

- Roll of 50 single use disposable training face shields for use with training manikin's
- Helps prevent cross infection between students
- Economical and easy to use



150.18.000	£19.40/roll (0.39p each)
CPR training manikin face shields, roll of 50	

AW Guardian Quick Save

- Mouth-to-mouth emergency resuscitation device comprising transparent face shield and one-way valve
- Supplied in transparent plastic bag with instructions
- Supplied individually or in economical bulk packs
- A quick release wall mounted storage container is also available



150.16.000	Guardian Quick Save, single unit	£3.10
150.16.000/10	Guardian Quick Save, pack of 10	£25.50
150.16.000/50	Guardian Quick Save, pack of 50	£114.30
150.16.000/1	Guardian Quick Save QR wall mounted storage container	£6.20

Your local medical supplier is just a phone call away. See cover for full details

Prices shown are exclusive of VAT and delivery

ECG 1/3 Channel

Cardioline ar600adv ECG

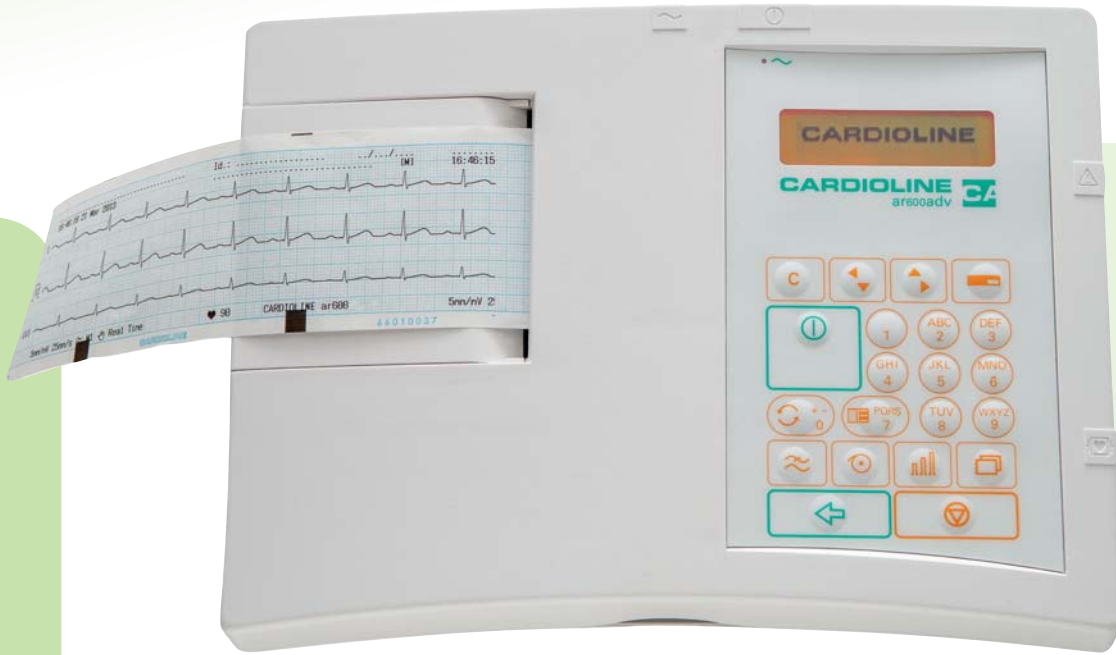

Package Includes:

- ar600adv ECG
- Mains power lead
- Patient connections
- User Guide
- Carry Case
- 1x paper roll/1x Z-fold pack
- 10 lead patient cable



ar600adv embodies the features of reliability, modularity, versatility and upgradability that characterise the latest generation of **CARDIOLINE®** electrocardiographs.

ar600adv is a portable electrocardiograph with dual power supply, (mains and rechargeable internal batteries), which in the basic configuration allows:

- Recording of an ECG in either automatic, manual mode and preprogrammed; printing the ECG on 60 mm in different format paper using a high-resolution thermal print: 1, 2, 2+R and 3 channel
- Storing the most recent ECG recording in automatic mode and printing additional copies of the ECG as required
- Obtain the measurement of the main ECG parameters.

Upgradeability

Thanks to the flexibility of the software used, the ar600adv can be adapted at any given moment to suit your individual requirements. The range of "options" offered have no restrictions or constraints, as the selection can be made either at the moment of purchase or later on at your clinic or surgery without having to interrupt day-to-day activity.

In just a few minutes your ar600adv can be equipped with:

- *Memory option:* storage of up to 20 full ECG exams, with no need to print out the ECG
- *ECG interpretation option:* automatic ECG interpretation program.

Operational Specification:

- Leads : 12 Standard or Cabrera
- Signal memory: 10 seconds for each lead in auto synchronous
- Recording sensitivity: manual: 2,5 – 5 – 10 – 20 mm/mV ± 5%
automatic: dependent on number of channels printed
- Writing system: Thermal printer, 8 dot/mm, usable print height 50 mm
- Print channels: 3
- Paper speed: 25 - 50 mm/s ± 5%
- Thermal paper: rolls : height 60 mm, length 15 m, gridded. pack of Z-Fold : length 20 m, page 70x60mm, gridded
- Pacemaker recognition: recognises pulse in accordance with current IEC standards
- Filters: Mains interference: Modified digital notch filter 50 - 60 Hz, Anti-drift: digital high-pass 0.5 Hz, linear phase
- Interpretation program: Parameter calculation, ECG interpretation (optional)
- Operating modes : manual: acquisition and printing in real time
automatic : simultaneous acquisition timed: acquisition at user-defined intervals
PC-ECG: real time acquisition with display at PC (optional)
Paper Saving: Automatic acquisition and archiving without printing

Technical Specification:

- Power supply: AC mains with external power supply 230V±10% 50/60 Hz. fused 0.5A
- Battery: Set of rechargeable NiMH batteries 8x1.2 Vdc; 1500 mAh
- Internal defibrillation protection
- Keyboard: Membrane, with functional and alphanumeric keyboard simplified
- Display: LCD 120x32 pixel
- Capacity: Internal battery: 3 hours in 1 channel mode
- Recharging time: Internal battery: 14 hours 100%
- Dimensions :250 x 60 x 185 mm (length x height x depth)
- Weight: 1000 grams with batteries, without paper
- Classification 93/42 CE: class IIa, CE0476

80409511	Cardioline ar600adv ECG	£967.50
-----------------	-------------------------	----------------

Options

9ME0600A	ECG Memory Upgrade	£107.50
9IN0600A	ECG Interpretation Upgrade	£107.50
66010037C	Paper Rolls x 10	£15.60
66010040C	Z Fold Paper x 10 Packs	£19.50

Your local medical supplier is just a phone call away. See cover for full details

Prices shown are exclusive of VAT and delivery

Cardioline ar600view ECG

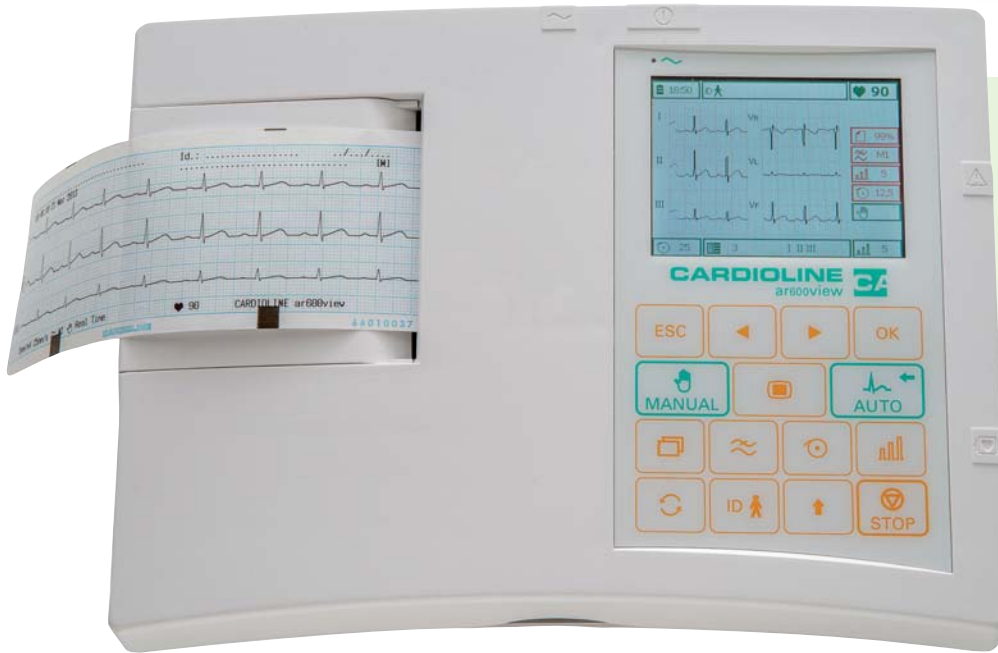

Package Includes:

- ar600view ECG
- Interpretation software
- Memory upgrade
- CubeECG PC software
- Mains power lead
- 10 lead patient cable
- Patient electrode connections
- User Guide
- Carry Case
- 1x paper pack



The ar600view is an ECG that incorporates high end functionality with portable characteristics. Memory interpretation and PC connectivity are standard as is the dual power supply system (mains or rechargeable battery).

- Registers ECG in automatic, manual and auto-timer mode; visualises the real-time ECG signal on its graphic display in the formats 3 and 3+3 channels
- Prints the ECG signal in high resolution on 60mm-paper with its thermal printer in various formats: 1, 2, 2+R, 3 and 6 channels
- Memorises the last automatic ECG for later printout of copies
- Organises tests by date/time and allows the input of patient as well as user data for management and recall
- Calculates ECG parameters automatically
- ar600view integrates data transmission to PC through a Bluetooth (Class 3) interface and archives tests on the PC with ECG management software ECG cubeecg (included). Allowing real time data transfer and upload of stored tests

The following features are included as standard on the ar600view ECG:

- *Memory:* files up to 100 tests without the need of immediate printing (paper saving mode)
- *ECG interpretation:* program for automatic parameter calculation and interpretation of the ECG signal
- *Bluetooth:* system ready for PC Connection, using cubeECG software which comes included with the device

Operational Specification:

- Writing system: Thermal printer at 8 dot/mm, usable print height 54 mm
- Print channels: 1, 2, 2+R, 3 and 6* (*only in manual mode)
- Paper speed: 10 – 12.5 - 25 – 50 mm/s
- Thermal paper: *roll:* length 15 m page 60x75mm, gridded, *Fold:* length 18 m, page 60x75mm, gridded
- Pacemaker detection: Detects pulse in accordance with current IEC standards
- Filters: *Mains interference:* modified digital notch filter 50–60 Hz, *Anti-drift:* 0.5 Hz digital high-pass, linear phase, *Muscle tremor:* 3 filters 35, 25 & 20 Hz
- Interface: Bluetooth Class I, USB (service only)
- Keyboard: Soft touch with 15 function keys
- Display: Visualisation of the 12 ECG channels, functional parameters, HR (30 - 300), incl. signal check, graphic colour LCD TFT, 3.5", resolution 320(RGB) X 240, colour depth 24bit, technology type a-Si, actual area (mm) 70.08 x 52.56, 6 LED backlight
- Operating modes: *Manual:* acquisition and printing in real-time *Automatic:* simultaneous acquisition with interpretation *Paper Saving:* acquisition and automatic archiving without printing

Technical Specification:

- Power supply: AC mains with external battery charger 230V±10% 50/60 Hz.;
- Battery: rechargeable battery pack NiMH 8x1.2 Vdc; 1,500 mAh
- Internal defibrillation protection
- Autonomy: *Internal battery:* 3 hours in 1-channel mode
- Recharging time: *Internal battery:* 14 hours to 100%
- Dimensions: 250 x 60 x 185 mm (length x height x depth)
- Weight: 1,000 grams without paper
- Classification 93/42 CE: class IIa, CE0476

80409108 Cardioline ar600view ECG BT package **£1709.00**

Options

66010037C	Paper Rolls x 10	£15.60
66010040C	Z Fold Paper x 10 Packs	£19.50

Your local medical supplier is just a phone call away. See cover for full details

Prices shown are exclusive of VAT and delivery

ECG 1/3 Channel

Kenz ECG305 Digital Electrocardiograph



Package Includes:

- ECG 305 ECG
- Mains power lead
- 10 lead patient cable
- Patient electrode connections
- 1x paper roll
- User instructions

1/3 channel digital electrocardiograph

Features

- Compact and lightweight, only 1.5kg
- Built-in rechargeable battery for superior portability
- 5.7 inch touch screen to display a full alphanumeric keyboard to enter patient information and preview of 12 lead ECG waveforms
- Optional external PC keyboard can be connected to the ECG 305
- Large data storage capability - internal memory for maximum 200 resting ECG and optional removal USB memory media
- Data transmission via LAN port, export in XML data format is possible
- Diverse recording formats - single channel, single channel + rhythm lead, 3 channels and long-term recording.
- Maximum 24 seconds of ECG per lead can be recorded
- ECG measurements can be output to support physician's diagnosis
- Barcode or magnetic card reader can be connected (optional)
- Built-in thermal printer 8 dot/mm

Recording Modes

Auto Mode

- Simple one touch operation of fully automatic ECG recording in preset format

Pre-Check Mode

- Standing by for occurrence of arrhythmia, provided arrhythmia is detected. ECG recording will be automatically started

Manual Mode

- Conventional manual ECG recording. Leads, speed sensitivity and filter can be selected manually

Long term Mode

- Recording a selected lead for long term recording (preset for 1 to 5 minutes or continuous recording time)

Specifications

Input impedance: 10M Ω or more

Leads: standard 12 leads and Cabrera leads

Patient input: one patient

Common mode rejection: 100dB or more

Polarization Voltage: \pm 500 mV or more

Frequency response: 0.05 to 150Hz, within -3dB to +0.5dB

Time Constant: 3.2 sec or more

Filter: Digital filter, hum noise drift (weak/normal),

Muscle (35/25Hz)

A/D Conversion: 12 bit (4.88 μ V/ digit)

Sampling Rate: 1,000 sampling/ sec. Pacemaker detection auxiliary function 10,000 samples/ sec

382-238367 Kenz ECG305 Digital Electrocardiograph **£1012.00**

Your local medical supplier is just a phone call away. See cover for full details

Prices shown are exclusive of VAT and delivery

Kenz Cardico C306 Diagnostic ECG

3 Channel Digital Electrocardiograph with Analysis



Features

- 5.7" touch screen for patient data entry and preview of 12 lead ECG and analysis results
- Huge data storage capability - Internal memory for maximum 200 resting ECG and removable USB memory for 5,000 ECG/ 2GB
- Data transmission with LAN port XML data format output is possible
- Direct connection with Epson inkjet printer
- USB port for connecting with external keyboard (optional)
- Analysis Report (Automatic)

382-237971	£1403.00
Kenz 306 Diagnostic Resting ECG	
382-238299	£345.00
CVS-03 DataViewer PC Software (LAN Connection)	

Print formats

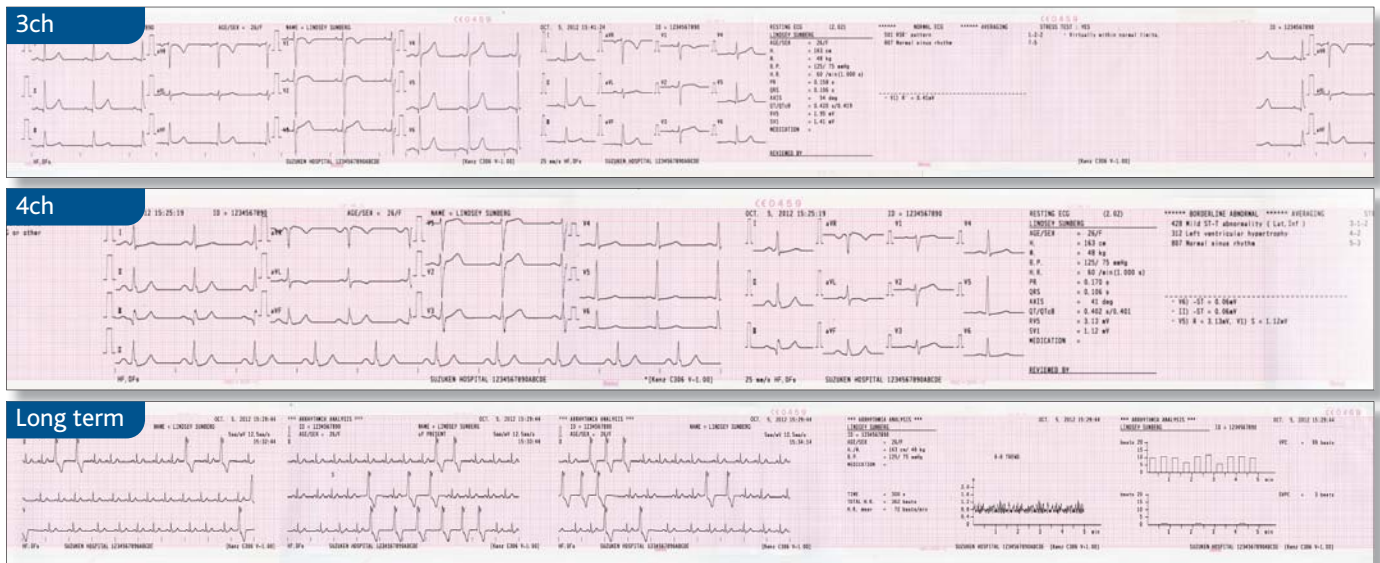

229

Recording Modes

- Auto mode - Simple one touch operation, freeze ECG display when abnormality is found and begin automatic recording and analysis
- Pre-check mode - Monitor occurrence of arrhythmia and if detected begin automatic recording and analysis
- Manual mode - Conventional manual ECG recording without analysis, manual selection of leads, speed, sensitivity and filter
- Long term mode - Analyse ventricular premature contraction, supraventricular premature contraction and atrial fibrillation, Automatic Nervous System test (ANST)

Data Management

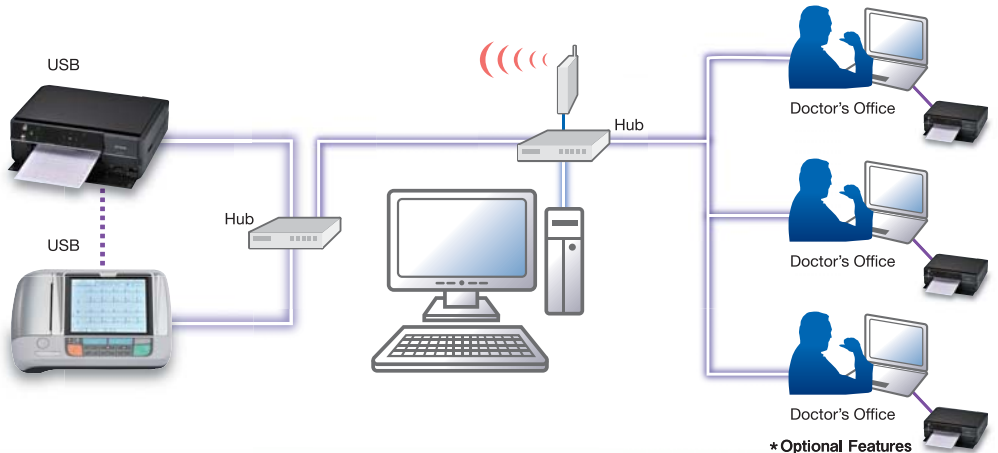

*Optional Features

Your local medical supplier is just a phone call away. See cover for full details
 Prices shown are exclusive of VAT and delivery

ECG 3/6 Channel

Cardioline ar1200viewBT ECG

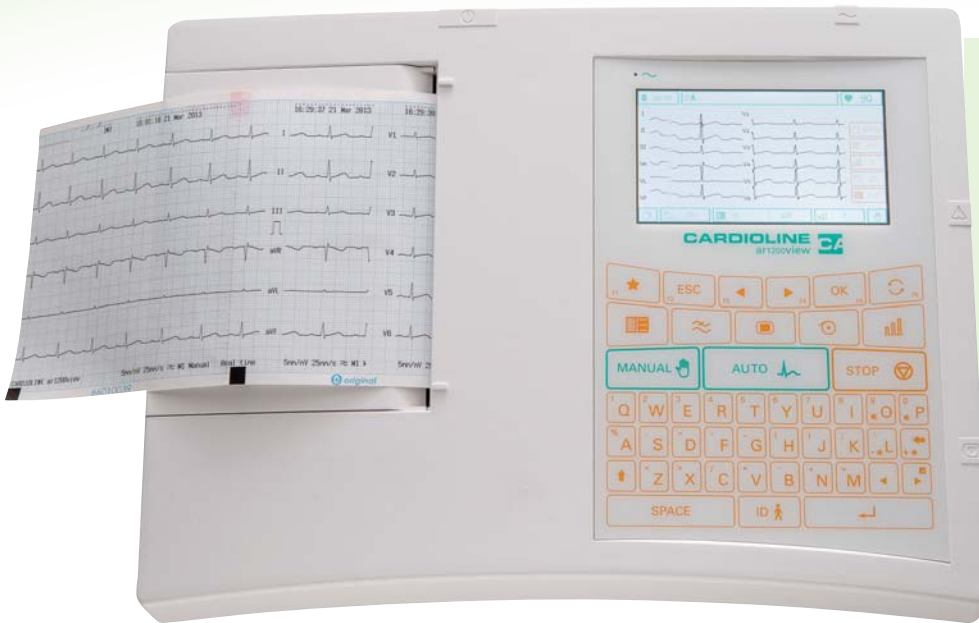

Package Includes:

- ar1200view ECG
- Interpretation and Analysis Software
- ECG Memory
- CubeECG PC Software
- Mains power lead
- 10 lead patient cable
- Patient electrode connections
- 1x paper pack
- Carry Case
- User Guide



ar1200viewbt embodies the features of reliability, modularity, versatility and upgradability that characterize the latest generation of **CARDIOLINE®** electrocardiographs with a multi-channel ECG recording 120 mm with 12 channel LCD colour graphic display TFT.

ar1200viewbt is an electrocardiograph with dual power supply, (mains and rechargeable internal batteries), which in the basic configuration allows:

- Recording of an ECG in either automatic or manual mode with preprogrammed set up and format
- Real time visualisation of the ECG signal on a graphic display in multiple formats: 3, 6, 6+6 ch
- Printing of the ECG on 120 mm format paper using a high resolution thermal printer
- Sorting of the tests according to time and date with QWERTY keyboard to manage user and patient data
- Effects automatic ECG parameter measurement
- Archive storage of ECG records in a personal computer running **cube** ecg software (included)
- Real time display of the 12 lead ECG on PC screen to allow management of patient medical records and archiving of ECG's in digital format using CubeECG software (included)

Thanks to the flexibility of the software used and to the Bluetooth Class I communication the **ar1200viewbt** can be adapted at any given moment to suit your individual requirements.

Key features of the **ar1200viewbt** included as standard:

Plus:

- Bluetooth (Class 1) data transmission to PC
- QWERTY keyboard for fast data entry
- *Memory option:* storage of up to 200 full ECG exams, with no need to print out the ECG
- *ECG analysis program:* automatic ECG interpretation program.

Operational Specification:

- Leads: 12 Standard or Cabrera with quality control of the electrodes connection
- Signal memory: 10 seconds for each lead automatic
- Recording sensitivity: manual and automatic : 2,5 - 5 - 10 - 20mm/mV \pm 5%
- Writing system: Thermal printer, 8 dot/mm, Useable print height 108mm
- Print channels: 3 / 3 + R / 6 / 12 (manual only)
- Paper transport speed: 5 - 10 - 12, 5 - 25 - 50mm/s
- Thermal paper: pack of Z-Fold : length 30m, page 120x100mm, gridded
- Pacemaker recognition: Recognises pulse in accordance with current IEC standards
- Filters: Mains interference: Modified digital notch filter 50 - 60 Hz linear phase, Anti-drift: 0.5 Hz high pass filters linear fase, always on, Muscular noise: 3 filters 20, 25 and 35 Hz
- Serial interface: Bluetooth Class I
- Keyboard: Soft touch keyboard with 47 function keys, 30 alphanumeric keys
- Display: Visualisation 12 ECG channels, functional parameters, HR (30 - 300), included control signalcolour graphic LCD TFT 480x272 pixel effective display area 95.04 x 53.856 mm, 9 led back light (4.3")
- Interpretation program: Parameter calculation ECG interpretation
- Operating modes : manual: acquisition and printing in real time automatic : simultaneous acquisition timed: acquisition at user-defined intervals PC-ECG: real time acquisition with display at PC, Paper Saving: Automatic acquisition and archiving without printing

Technical Specification:

- Mains power supply Internal power supply 90-264 V 47/63Hz
- Battery: Set of rechargeable NiMH batteries 10x1.2Vdc; 1800 mAh
- Internal defibrillation protection
- Capacity: Internal battery: 100 min. in 3 channel mode
- Recharging time: Internal battery: 18 hours 100%
- Dimensions: 320 x 72 x 240 mm (length x height x depth)
- Weight: 2150gr. without paper
- Class (93/42/EEC Directive): IIa, CE0476

80509580 Cardioline ar1200viewbt ECG

£2031.75

Your local medical supplier is just a phone call away. See cover for full details

Prices shown are exclusive of VAT and delivery

Kenz Cardico C601 Diagnostic ECG

6 Channel Digital Electrocardiograph with Analysis

Features

- 5.7" touch screen for patient data entry and preview of 12 lead ECG and analysis results
- Huge data storage capability - Internal memory for maximum 200 resting ECG and removable USB memory for 5,000 ECG/ 2GB (optional)
- Data transmission with LAN port XML data format output is possible
- Direct connection with Epson inkjet printer
- USB port for connecting with external keyboard
- Compact dimensions 290 x 200 x 70mm
- Weight just 2.2kg



Package Includes:

- Cardico 601 ECG
- Mains power lead
- 10 lead patient cable
- Patient electrode connections
- 1x paper pack
- User Guide

382-237964 £1655.50
Kenz ECG601 Digital Electrocardiograph

382-238282 £345.00
CVS-03 DataViewer PC Software
(USB Connection)

Print formats

3ch

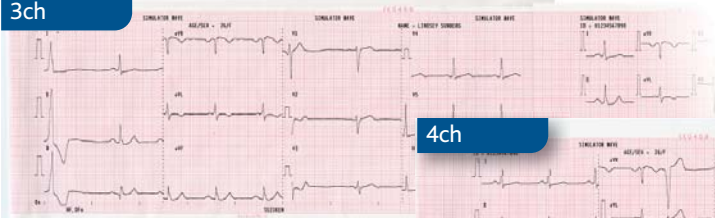

4ch

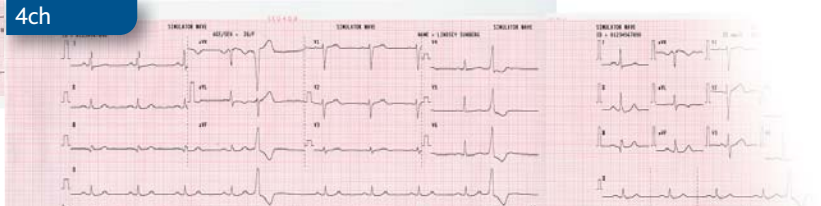

Analysis

6ch

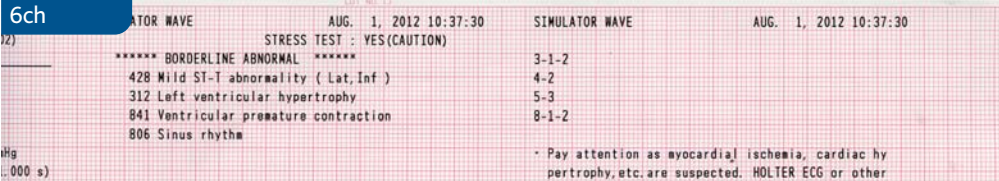

Long term

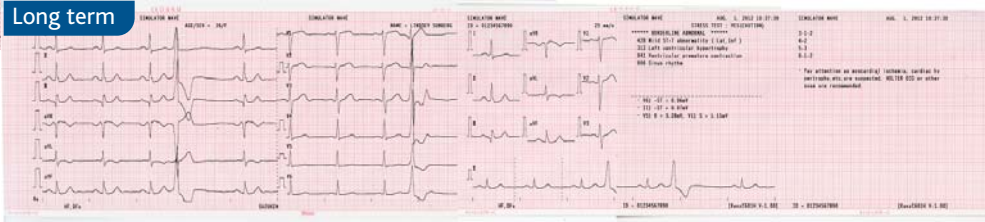

Recording Modes

- Auto mode - Simple one touch operation, freeze ECG display when abnormality is found and begin automatic recording and analysis
- Pre-Check mode - Monitor occurrence of arrhythmia and if detected begin automatic recording and analysis
- Manual mode - Conventional manual ECG recording without analysis, manual selection of leads, speed, sensitivity and filter
- Long term mode - Analyse ventricular premature contraction, supraventricular premature contraction and atrial fibrillation, Automatic Nervous System test (ANST)

Data Management

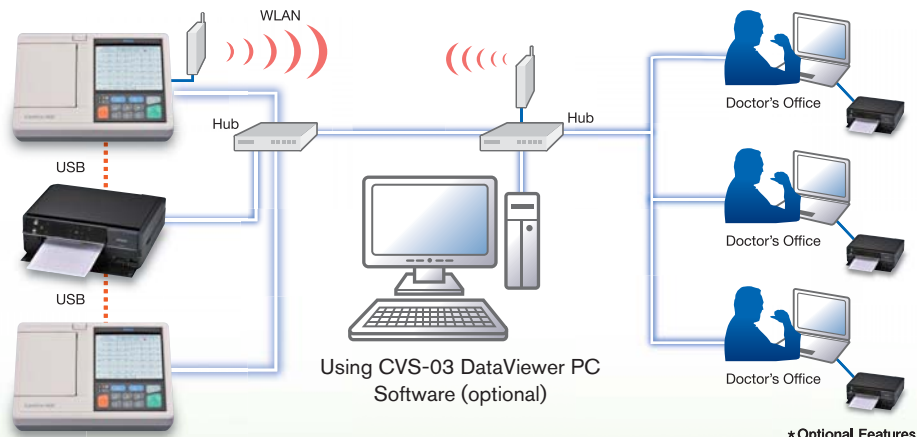

*Optional Features

Your local medical supplier is just a phone call away. See cover for full details

Prices shown are exclusive of VAT and delivery

ECG 12 Channel

Cardioline ar2100view BT

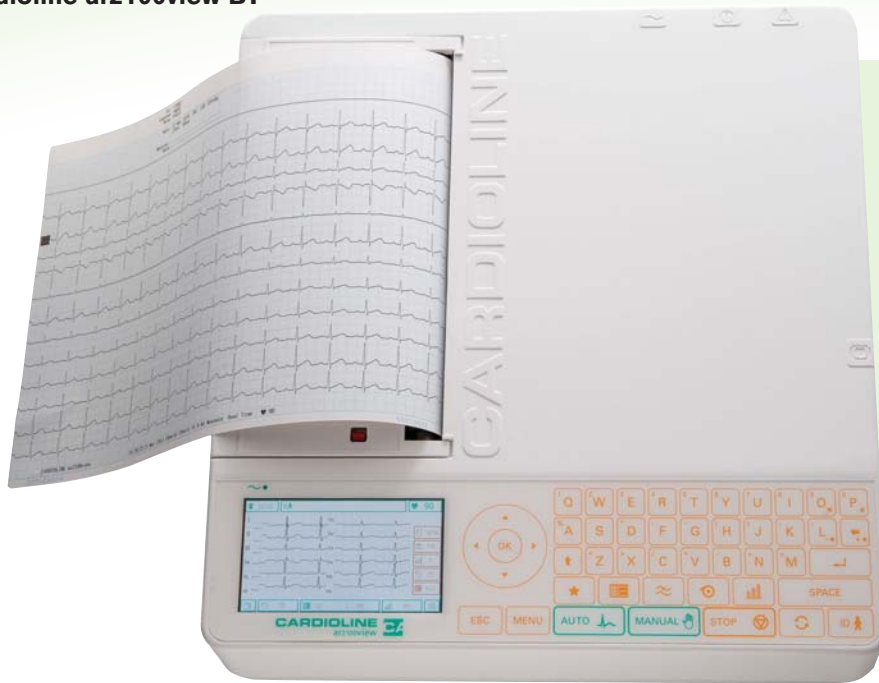

Package Includes:

- ar2100view BT ECG
- ECG Interpretation and Analysis Software
- ECG Memory Upgrade
- CubeECG PC Software Suite
- Mains power lead
- 10 lead patient cable
- Patient electrode connections
- 1x paper pack
- User Guide



At the head of the new family of Cardioline ar Series ECG machines is the new **ar2100view BT** ECG. Featuring A4 printout, QWERTY keyboard, comprehensive diagnostic capability and wireless Bluetooth (Class 1) communication to PC - all as standard!

The colour display shows up to 12 ECG leads at a time for patient monitoring and pre-checking signal quality. With dual power supply (mains and rechargeable battery) and simple one button operation, the **ar2100view BT** provides a quality ECG in a choice of formats in just a few minutes.

- *Memory option:* storage of up to 200 full ECG exams, with no need to print out the ECG
- *ECG analysis program:* automatic ECG interpretation program

ar2100view BT includes a Bluetooth class 1 interface for data transmission to Cube ECG PC Software. **ar2100view BT** has dual power supply (mains and rechargeable internal batteries), which in the basic configuration allow:

- Recording of an ECG in either automatic, manual mode and preprogrammed
- Printing the ECG on 210 mm in different format paper using a high resolution thermal printer, in multiple formats
- Sorting of the tests according to time and date and alphanumeric keyboard to manage user and patient data
- Effect the automatic ECG parameter measurement
- Archive the ECG in a personal computer running cubeecg software (optional)
- Visualise the real time display of the 12 ECG leads on a personal computer screen via Bluetooth to allow management of patient medical records and archiving of ECG's in digital format, using cube ecg software (included)

Operational Specification:

- Leads: 12 leads Standard, Cabrera with quality control of the electrodes connection
- Signal memory: 10 seconds for each lead in auto isochronous
- Recording sensitivity: Manual and automatic: 2,5 - 5 - 10 - 20mm/mV \pm 5%
- Writing system : Thermal printer 8 dot/mm, useable print height 210mm
- Print format: 3 / 6 / 12 / D3+1 / D3+3 / D6x2 / D12
- Paper transport speed: 5 - 10 - 12,5 - 25 - 50 mm/s
- Thermal paper: Z-Fold pack: page 210x280mm 200 pages, gridded
- Pacemaker recognition: Recognises pulse in accordance with current IEC standards
- Filters: Mains interference: Modified digital notch filter 50-60 Hz linear phase, Anti-drift: Digital high-pass 0.5 Hz, linear phase, always enabled. muscular tremors: 3 frequencies: 20, 25 and 35 Hz
- Serial interface: Bluetooth class I
- Keyboard: Capacitive with 47 keys
- Display: Visualisation 12 ECG channels, functional parameters, HR (30 - 300), included contact electrodes control signal, Colour graphic LCD TFT 480x272 pixels, display effective area 95.04 x 53.856 mm, led backlit (4,3")
- ECG interpretation with parameters, analysis and measurements
- Operating modes : Manual: acquisition and printing in real time, Automatic: simultaneous acquisition PCECG: real-time acquisition with visualisation on PC (optional), Paper Saving: acquisition and automatic archive without printing (optional)

Technical Specification:

- A.C. mains power supply: Internal power supply 90-250V 47/63Hz
- Battery: Rechargeable lead battery NiMH 10x1,2 Vdc; 2000 mAh
- Internal defibrillation protection
- Battery capacity: Internal battery: 80 minutes. printing 6 channels
- Recharging time: Internal battery: 10 hours 100%
- Housing protection degree: IP 20
- Dimensions: 325 x 80 x 345 mm (length x height x depth)
- Weight.: 3700 gr. without paper

80609310	Cardioline ar2100view package	£2461.75
66010042C	ECG Paper Pack x 5	£65.00

Your local medical supplier is just a phone call away. See cover for full details

Prices shown are exclusive of VAT and delivery

Kenz Cardico 1210 Digital Electrocardiograph



Package Includes:

- Cardico 1210 ECG
- Mains power lead
- 10 lead patient cable
- Patient electrode connections
- 1x paper pack
- User Guide

Twelve channel precision digital electrocardiograph with analysis and various features to meet your requirements.

The Kenz Cardico 1210 is a sophisticated 12-channel digital Electrocardiograph that is superior in arrhythmia analysis. It comes with more than 130 diagnostic statements to meet doctor's requirements in ECG analysis. The built-in high resolution printer enables excellent quality ECG tracing in various formats. ECG can also be printed on a plain A4 size paper by using an external printer connecting to a PC with the optional software (ECG Data Viewer CVS-03). The internal memory enables storing and managing of 100 ECG data records.

Features:

- Twelve channel Electrocardiograph, with 4 automatic (3, 4, 6 or 12-channel), 1 manual and 1 arrhythmia recording mode :
- Post-stress
- Pre-check mode: for checking for arrhythmia before recording
- Automatic adult and pediatric analysis programs are standard
- 100 ECG data can be stored internally
- More than 130 diagnostic statements to meet doctor's requirements in ECG recording
- Features a serial port, for transmitting ECG data to a PC. Optional CVS-03 software is available for data viewing and record management
- Rechargeable battery and AC operation
- Easy operation : just one touch of the RUN/STOP key can record standard 12 leads ECG and print analysis reports in 7 languages (English/Spanish/Italian/French/German/Chinese/Russian)
- Patient demographic information input : ID number (up to 12 digits), age, sex, height, weight, blood pressure, conditions, medications and name.
- Message display : various messages guide the user for proper operation
- ECG preview display: The Kenz Cardico 1210 has a large back-lit LCD (5.7 inch) to display three channel ECG, which previews in order to verify abnormalities and ensure quality tracings, thus saving time and paper
- ECG freeze display: allows freezing and printing of the ECG waveform displayed on the LCD
- 12 Lead scanning display: the SCAN key allows the user to preview all the 12 leads at a glance to verify ECG quality prior to recording with leads-off indicator
- Various printing possibilities: user can print in 3-, 4-, 6- or 12-channel formats on thermal paper using the internal thermal printer or use an external printer to record on normal A4 paper, through a PC by using the CVS-03 software
- Data management: the user can manage the data stored in the internal memory by ID number or date of recording
- Digital filters for AC current, muscle tremor and baseline drift
- Pacemaker detection
- Defibrillation protection



382-231214	Cardico 1210 ECG	£2760.00
382-238275	CVS-03 PC Software (RS232 Serial Connection)	£345.00

Your local medical supplier is just a phone call away. See cover for full details

Prices shown are exclusive of VAT and delivery

ECG 12 Channel

Kenz Cardico C1215 Digital Interpretive ECG

12 Channel Digital Interpretive Electrocardiograph



- Package Includes:**
- Cardico 1215 ECG
 - Mains power lead
 - 10 lead patient cable
 - Patient electrode connections
 - 1x paper pack
 - User Guide

Features:

- 8.5" colour WVGA touch screen for superior visibility of ECG waveforms
- Slim and lightweight design for easy mobility
- Auto, manual and long term recording modes
- 3, 4, 6 or 12 channel ECG recording with analysis
- Z fold or roll paper in A4 letter sizes
- Membrane alphanumeric keyboard for easy cleaning and maintenance
- Internal memory for 1,000 ECG data and optional removable USB media
- Data transmission via LAN to Kenz ECG Data
- Barcode and magnetic card scanning options
- Automatic nervous system test in long term recording mode

Print formats

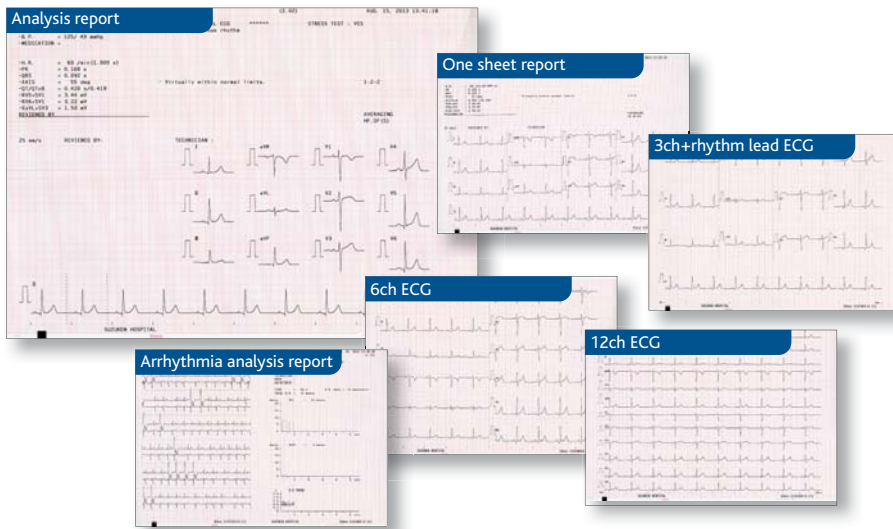

382-238268	£3680.00
Kenz Cardico C1215 Digital Interpretive ECG	
382-238299	£345.00
CVS-03 Data Viewer Software (LAN Connection to PC)	

Data Management

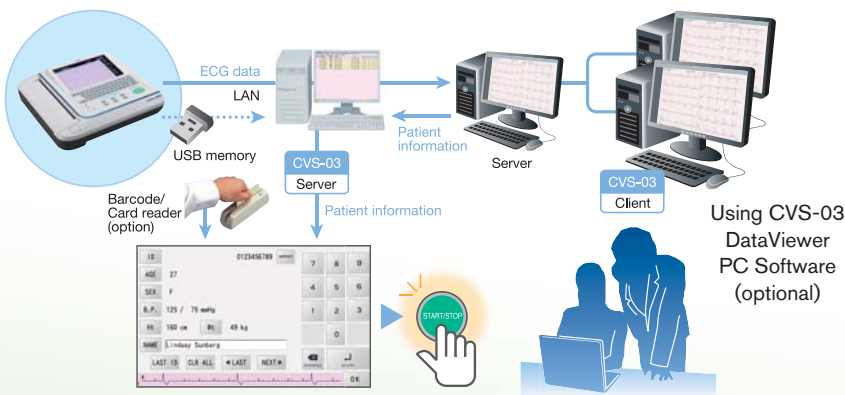

Specialist Recording Modes

- Arrhythmia - Capturing arrhythmia displayed on screen by pressing freeze screen, record simultaneous 12 lead ECG
- Long term mode - Analyse ventricular premature contraction, supraventricular premature contraction and atrial fibrillation, Automatic Nervous System test (ANST)

Your local medical supplier is just a phone call away. See cover for full details
Prices shown are exclusive of VAT and delivery

Kenz Cardico PC1201 - PC ECG

12 Channel Digital Interpretive Electrocardiograph

PC1201 direct to PC ECG, performs with the ease and speed of a traditional desk ECG and offers the user enhanced data management functionality. Using the Data Viewer PC Software included.

One-button creation means obtaining the ECG couldn't be simpler:

- Connect the patient
- Enter patient data in Viewer Software
- Press control button on PC1201 Recorder

The ECG signal is transmitted wirelessly to the PC, where it can be viewed in real-time, saved, printed, exported and archived.

- Lightweight, portable signal
- Easy and fast to use
- Full archive and management capability
- Wireless data transmission
- Intuitive PC software, with export facility
- 2, 3+R, 6 and 12 channel display
- A4 reporting in a choice of formats
- Operation Modes: auto, pre-check, trace-back (5 minute memory), arrhythmia, autonomous nervous system test, freeze



382-838244 **£2070.00**
Kenz Cardico C1201 Expandable PC ECG

Print formats

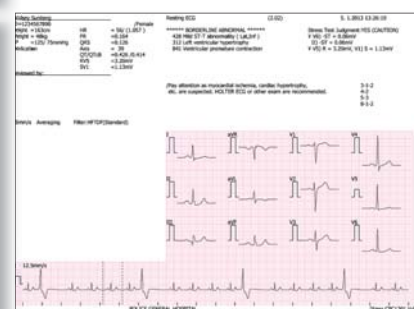
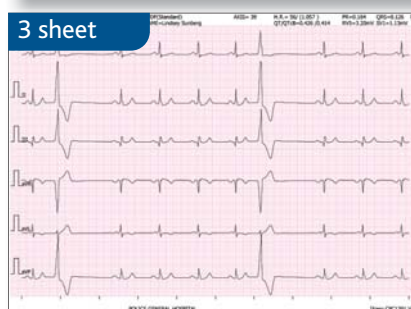
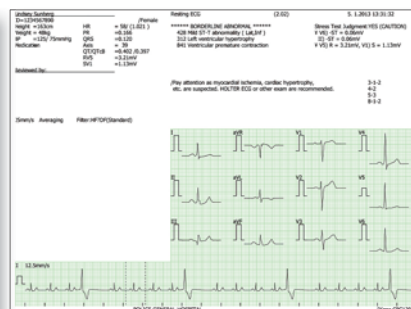
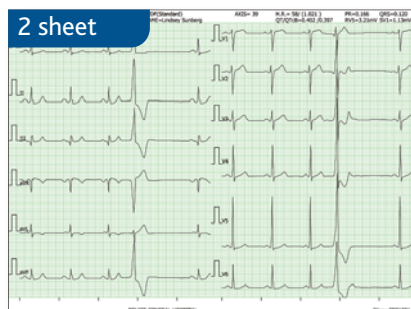

Data Management



Package Includes:

- PC 1201 PC ECG
- 10 lead patient cable
- Patient electrode connections
- Data Viewer PC Software
- Batteries
- User Guide

Your local medical supplier is just a phone call away. See cover for full details

Prices shown are exclusive of VAT and delivery

ECG Direct to PC

Cardioline touchecg



Thanks to **touchecg** high performance, it is possible to record and memorise a high number of resting ECG tests. It also allows full-disclosure ECG monitoring for over 30 minutes. Recorded waveforms can be displayed in real time and printed later on; this allows clinicians to evaluate patients with arrhythmias or ischemia, and record post-mortem ECGs.

touchecg provides an interpretation of the electrocardiogram, an ECG measurement table for each lead and, if desired, manual ECG reporting.

touchecg is a 12-lead resting electrocardiograph based on a high-resolution, touch-screen tablet pc and **clickcecgbt** acquisition unit, communicating via Bluetooth technology. The system can also be installed on a desktop or a laptop.

The tablet user interface features large function keys recalling the keys of a traditional electrocardiograph; this makes learning how to use the device a quick and user friendly process.

The screen simultaneously displays all 12 ECG leads in a clear, legible way, thus helping clinicians in their work. It displays up to 150 seconds ECG preview; this helps the choice for the best starting point for acquisition.

Several A4 printing formats are available; by transferring the test to an ECG management system, it is also possible to operate in paperless mode.

By means of advanced WIFI connectivity, it is possible to export the exams as .scp or .pdf files, as images (.png or .jpg), or in standard XML, GDT, DICOM (optional) formats; worklist management is also available.

clickcecgbt is the ECG signal acquisition unit. It features simultaneous 12 lead ECG acquisition from patients.

Small and lightweight (only 100 grams), **clickcecgbt** maximises patient comfort and is robust and easy to use.

Operational Specification:

- Acquisition modality: 10s automatic, manual, userdefinable 10s-interval buffer
- Visualisation: 6 or 12 user-selectable leads; sweep speed and waveform display amplitude can be modified
- Printout: User-selectable
- Printout formats: A4; different report layouts can be customised
- Analysis: Automatic interpretation and measurement program
- Recording storage: Automatic; database included in the program
- Data export: In the following formats: scp, image (png or jpg) pdf, standard XML, GDT, DICOM (optional)
- Worklists: Worklist management available
- ECG sampling rate: 500 Hz/16bit channel
- Signal overload measurement: Independent on each channel
- Pace-maker detection: Hardware detection on leads II, V4 and V5: always on
- Real-time transmission: Wireless Bluetooth connection, Class I
- LED ECG acquisition unit: 1 two-color LED (greenred) for battery status testing; 1 LED (blue) for Bluetooth connection testing
- Defibrillation protection: Through original patient cable

Technical Specification:

- Tablet pc: Touch-screen tablet pc, 11.6" screen
- Processor: Intel Atom multi core or superior
- Memory: 64GB MMC on board, 2GB RAM
- Communication: BT4.0 w WIFI (802.11abgn)
- Operating System: Windows 8 32bit
- Power Supply/Battery: Adapter 40W / 2 cells
- Acquisition unit power supply: 2 AA batteries, ultra alkaline or NiMh rechargeable (2500mAh minimum)
- Chassis protection: IP20
- Applied parts: CF type
- Classification (EN60601-1): Internally-powered device
- Class (93/42 EEC Directive): IIa

Your local medical supplier is just a phone call away. See cover for full details

Prices shown are exclusive of VAT and delivery

touchecg package (option 1)

This configuration is equipped with a tablet pc, touchecg program, clickecgbt acquisition unit with accessories.

Includes:

- Touch-screen tablet pc
- Tablet case
- "Cardioline 120" carry bag
- clickecgbt acquisition unit
- 10-wire patient cable, banana plug
- Clip electrode set, 4 pcs/set, IEC
- Suction electrode set, 6 pcs/set
- def-gel bottle, 260 grams
- Cardioline ECG measuring ruler
- clickecg carry bag
- 1.5V alkaline battery
- clickecgbt User Manual
- touchecg User Manual



Cardioline touchecg



Option 1

81019606 Cardioline touchecg package **£2687.50**

touchecg system (option 2)

This configuration is equipped with a tablet pc, touchecg program, a cart, clickecgbt acquisition unit with accessories.

Includes

- Touch-screen tablet pc
- clickecgbt acquisition unit
- 10-wire patient cable, banana plug
- clip electrode set, 4 pcs/set, IEC
- suction electrode set, 6 pcs/set
- def-gel bottle, 260 grams
- Cardioline ECG measuring ruler
- clickecg carry bag
- 1.5V alkaline battery x 2
- clickecgbt User Manual
- touchecg User Manual
- 5-wheel dedicated cart, featuring a tablet pc mount



Option 2

81019607 Cardioline touchecg system **£3010.00**

Accessories

63030105	Set of 4 ECG limb electrodes, clamp, Ag/Agcl	£38.70
ML1865W	BW wireless laser printer	£215.00
63030106	Set of 4 ECG limb electrodes, clamp, neutral colour, Ag/Agcl	£48.00
63030107	Set of 4 ECG pediatric limb electrodes, clamp, Ag/Agc	£54.00
63030163	Set of 6 ECG precordial suction electrodes, Ag/Agcl	£59.90
63050078	ECG patient cable, IEC, 10 wires, clips, 4mm	£213.93
63050081	Stress test patient cable, IEC, 10 wires, snap	£213.93
65090064	"Cardioline clickecg" carry bag	£70.95
66020002	ECG electrode gel, bottle, 260ml	£4.30

63090236	Set 10 adapters, snap, 4mm	£33.50
66020028	ECG measuring ruler	£6.00
66030031C	Disposable ECG electrodes, snap, 50 pcs/box	£16.13
66030032C	Disposable stress-test electrodes, snap, 50 pcs/box	£32.25
66030034C	Disposable ECG electrodes, tab, 100 pcs/box	£16.13
66030036C	Disposable ECG electrodes, neonate, 25 pcs/box	£70.95
66030037C	Disposable ECG electrodes, banana plug, 50 pcs/box	£23.65
65090057	"Cardioline 120" carry bag	£47.30
XE500COV	Tablet pc case	£96.75

Your local medical supplier is just a phone call away. See cover for full details

Prices shown are exclusive of VAT and delivery

ECG Accessories

Universal ECG Trolley



- Robust, hard-wearing ECG trolley
- Optional: Patient cable boom (as pictured)
- Large platform in tough plastic fits all ECG machines
- Easy to clean surfaces
- Steel framework in complimentary royal blue finish
- Large 80mm castors with brakes
- Drawer as standard
- Shelf with formed compartments for accessory storage
- Excellent value for a quality trolley

63090220 Universal ECG Trolley **£445.00**

63090136 Patient cable arm **£140.00**

238

Connectors and Clips for Single-Use Electrodes

Press-Stud Adaptors

- For use with Guardian and other press-stud electrodes
- 4mm lead fitting
- Sold in set of 10 for convenience



63090236 **£33.50**

Set of 10 press-stud adaptors

Alligator Adaptors – Round Type



- For use with resting ECG tab electrodes
- Easy to apply
- Available individually or in packs of 10

CA500 **£3.20**

Alligator adaptor, round, each

CA500/10 **£29.50**

Alligator adaptor, round x 10

Alligator Adaptors – Flat Type

- For use with resting ECG tab electrodes
- Easy to apply and excellent grip
- Available individually or in packs of 10



CART105 **£4.50**

Alligator adaptor, flat, each

CART105/10 **£41.00**

Alligator adaptor, flat x 10

Your local medical supplier is just a phone call away. See cover for full details

Prices shown are exclusive of VAT and delivery

Reusable ECG Electrodes

- **Reusable Electrodes** – Silver/Silver Chloride for good signal strength
- **Chest Electrodes** – traditional suction-cup type
- **Limb Electrodes** – clamp-type in adult or paediatric sizes, colour-coded

A full range of ECG spares and accessories are available on request. Please call for details of other spare parts, including replacement patient cables

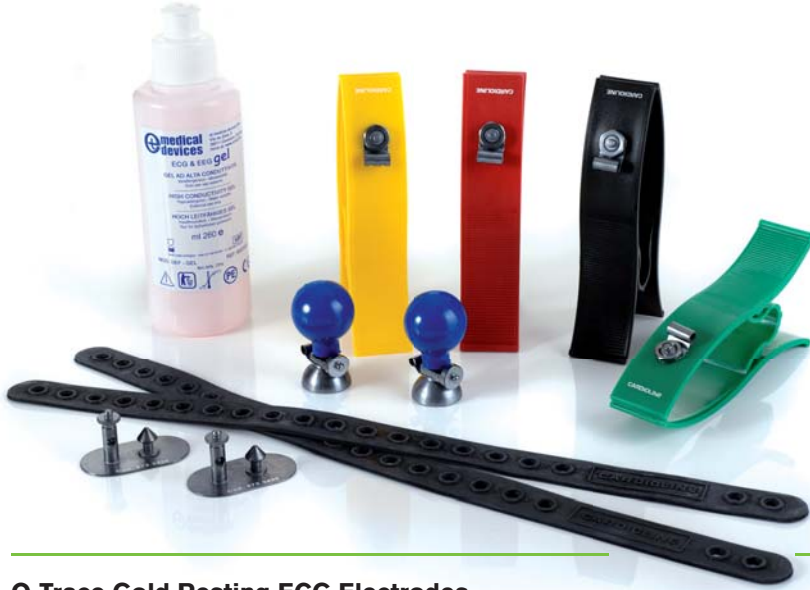

63030163	£11.00
Suction-cup chest electrode, each	
63030163/6	£59.90
Suction-cup chest electrode x 6	
63030106	£48.00
Limb clamp electrodes, adult, set of 4	
63030107	£54.00
Limb clamp electrodes, paediatric, set of 4	
8733405	£6.50
Limb electrode plate, without strap, each	
8940438	£2.40
Rubber limb strap, for use with 8733405 electrode	

Other ECG accessories

99.800.35	£2.45
Guardian ECG electrode gel, 250ml	
66020028	£6.00
ECG Ruler	

Q-Trace Gold Resting ECG Electrodes



- **Single-Use Tab Electrodes** – suitable for resting ECG
- **Silver/Silver Chloride Contact** – superb contact and signal strength
- **Manufactured by Tyco Healthcare** – quality assured
- **Choice of pack sizes** – available in sachets of 100 electrodes and boxes of 5 x 100 electrodes

QTE5500	£9.00
Q-Trace Gold Electrodes, pack 100	

QTE5500/5	£35.00
Q-Trace Gold Electrodes, box 5 x 100	

Guardian ECG Tab Electrodes

- **Single-Use Tab Electrodes** – suitable for resting ECG
- **Silver/Silver Chloride Contact** – good skin contact and signal strength
- **High Quality** – reliable and easy to use
- **Superb Value** – lower cost without compromising quality
- **Choice of pack sizes** – available in sachets of 100 electrodes and boxes of 5 x 100 electrodes



99.832.38	£7.65
Guardian Tab Electrodes, pack of 100	

99.832.38/5	£29.00
Guardian Tab Electrodes, 5 x 100	

Guardian Press-Stud ECG Electrodes

- A range of pregelled ECG electrodes designed to give excellent adhesion and signal transmission, ideal for long-term monitoring and stress test ECG
- Press-stud connections (requires 63090236 adaptors, shown below)
- Foam backed with a choice of solid or aqueous gel conductor
- Silver / Silver Chloride (Ag/AgCl) sensor
- 24 month shelf life



99.830.03	£3.80
Adult 50mm solid gel, pack of 30	
99.830.17	£4.25
Child 30mm solid gel, pack of 30	
99.832.02	£4.25
Adult 50mm aqueous gel, pack of 30	

Your local medical supplier is just a phone call away. See cover for full details

Prices shown are exclusive of VAT and delivery

Our most popular ECG papers – at a glance



Brand:	Size:	Roll/Z-fold pack:	Code:	Quantity:	Price:
Cardioline					
Delta 1plus	60mm x 30m	Roll	10.060.06	1	£2.70
Delta 1plus	60mm x 30m	Roll	10.060.06/10	10	£24.50
Delta 1plus	60mm x 300p	Z-fold	29.060.03	1	£5.80
Delta 1plus	60mm x 300p	Z-fold	29.060.03/10	10	£54.10
Delta 3plus	110mm x 300p	Z-fold	29.112.00	1	£5.60
Delta 3plus	110mm x 300p	Z-fold	29.112.00/10	10	£53.10
Delta 60plus	210mm x 30m	Roll	10.210.06	1	£7.80
Delta 60plus	210mm x 30m	Roll	10.210.06/10	10	£72.00
Delta 60plus	210mm x 200p	Z-fold	29.210.06	1	£15.00
Delta 60plus	210mm x 200p	Z-fold	29.210.06/10	10	£141.80
Elan	210mm x 200p	Z-fold	29.210.06	1	£15.00
Elan	210mm x 200p	Z-fold	29.210.06/10	10	£141.80
Elan 1100	112mm x 300p	Z-fold	66010044	1	£7.00
Elan 1100	112mm x 300p	Z-fold	66010044C	10	£62.80
AR600	60mm x 30m	Roll	10.060.17	1	£2.30
AR600	60mm x 30m	Roll	10.060.17/10	10	£19.90
AR1200	120mm x 300p	Z-fold	29.120.06	1	£6.10
AR1200	120mm x 300p	Z-fold	29.120.06/10	10	£57.20
AR1200	120mm	Roll	10.120.09	1	£5.10
AR1200	120mm	Roll	10.120.09/10	10	£45.90
AR2100	210 x 140mm	Z-fold	66010045	1	£11.80
AR2100	210 x 140mm	Z-fold	66010045C	5	£63.90
Seca					
Seca CT1000	50mm x 30m	Roll	10.050.06/10	10	£27.60
Seca CT6 range	210mm x 280mm x 215p	Z-fold	29.210.15/10	10	£158.10
Seca CT3000	90 x 70mm /400p	Z-fold	29.090.00/10	10	£41.90
Seca CT6300–6600	210 x 150mm /170p	Z-fold	29.210.08	10	£56.10
Seca CT3000B M I		Roll	10.090.01	10	£39.30
Schiller					
Schiller AT1	90mm x 90mm x 400p	Z-fold	29.090.01	10	£48.00
Schiller AT101	80mm x 70mm x 315p	Z-fold	29.080.00	10	£41.90
Schiller AT2	210mm x 280mm x 215p	Z-fold	29.210.15	10	£158.10
Schiller AT3	70mm x 100mm x 200p	Z-fold	SH70100P	10	£50.50
Schiller AT4	90mm x 90mm x 200p	Z-fold	SH9090P2	10	£60.20
Schiller AT5	135mm x 140mm x 150p	Z-fold	SH135140P	10	£66.30
Schiller AT6/M/C/i	144mm x 100mm x 350p	Z-fold	SH145100P	10	£91.30
Kenz					
Kenz Cardico 601	112mm x 90mm x 300p	Z-fold	29.112.99	5	£28.10
Kenz 108/110	50mm x 30m	Roll	10.050.06/5	5	£14.80
Kenz Cardico 302		Z-fold	29.112.02	5	£38.50
Kenz Cardico 1210		Z-fold	29.210.99	5	£89.50
Kenz Cardico 1210		roll	10.210.06/10	10	£77.20
Kenz Cardico 1211		Z-fold	382-036888	5	£86.40
Guardian/Contec					
ECG-CMS80	57mm x 25m	Roll	10.057.05	1	£2.10
ECG-100G	50mm x 30m	Roll	10.050.03	1	£2.10
ECG-300G	80mm x 30m	Roll	10.080.11	1	£4.00
ECG-600G	110mm x 20m	Roll	10.110.99	1	£4.90

Your local medical supplier is just a phone call away. See cover for full details

Prices shown are exclusive of VAT and delivery

Other ECG papers

Brand:	Size:	Roll/Z-fold pack:	Code:	Quantity:	Price:
Cardioline					
Delta 1	50mm x 30m	Roll	10.050.06	1	£3.10
Delta 1	50mm x 30m	Roll	10.050.06/10	10	£27.60
ETA 150	50mm x 30m	Roll	10.050.06/10	10	£27.60
Cardioline E1	50mm x 30m	Roll	FUD5030	10	£37.80
Cardioline E3	134mm x 30m	Roll	CA13430	10	£68.40
Other makes					
Astron Replay	50mm x 15m	Roll	ET5015	10	£29.60
Astron 12/1	50mm x 30m	Roll	ET5030	10	£37.80
Astron 12/3	134mm x 30m	Roll	ET13430	10	£83.70
Astron 3x12l	120mm x 30m	Roll	ET12030	10	£58.20
CR200		Roll	FUD5030	10	£37.80
Cardiorapid K112	50mm x 15m	Roll	ET5015	10	£29.60
Cardiorapid K36	120mm x 30m	Roll	ET12030	10	£58.20
Cardiorapid K31-K131	134mm x 30m	Roll	ET13430	10	£83.70
CME100P		Roll	ET5030	10	£37.80
CME300P-600l		Roll	ET12030	10	£58.20
ET Microruler 12/1	50mm x 15m	Roll	ET5015	10	£29.60
ET Autoruler 12/1	50mm x 30m	Roll	ET5030	10	£37.80
ET Excel 103-106	120mm x 30m	Roll	ET12030	10	£58.20
ET start 100	130mm x 25m	Roll	ET13025	10	£58.20
ET Daed.346 & View	209mm x 20m	Roll	ET20920/1A1	10	£79.95
ET start 200 & 200HV	209mm x 20m	Roll	ET20920/1A1	10	£79.95
ET ar2100 & ar2100view	209mm x 20m	Roll	ET20920/1A1	10	£79.95
ET ar600 & ar600adv	60mm x 15m	Roll	10.060.17/10	10	£19.90
ET ar600 & ar600adv	60mm x 75mm x 250p	Z-fold	ET6075P	10	£29.60
ET ar1200 & ar1200adv	120mm x 20m	Roll	10.120.09/10	10	£45.90
ET ar1200 & ar1200adv	120mm x 100mm x 300p	Z-fold	29.120.06/10	10	£57.20
Esaote C1	50mm x 30m	Roll	OB5030	10	£37.80
Esaote C3		Roll	OB13330	10	£52.00
Esaote C3 Personal	142mm x 30m	Roll	OB14230	10	£52.00
Fukuda ME 501F & B		Roll	FUD5030/1	10	£37.80
Fukuda ME 501A		Z-fold	FUD5070P	10	£50.50
Fukuda Denshi FK11/12		Roll	FUD5030	10	£37.80
Fukuda D. FD15/16		Roll	FUD5030	10	£37.80
Fukuda D. FX121/1201	50mm x 30m	Roll	FUD5030	10	£37.80
Fukuda D. FX2111/2155	63mm x 30m	Roll	FUD6330	10	£50.50
Fukuda D. FX3010	144mm x 30m	Roll	FUD14530	10	£66.20
Hellige Servomed		Roll	HE5030M	10	£37.80
Hellige EK75 100 31	49mm x 50m	Roll	HE5050	10	£50.50
HP 100-200 Pagewriter	210mm x 300mm x 200p	Z-fold	HP210300P2	10	£95.10
Kenz 130/106 50mm		Roll	CA5030	10	£37.80
Kenz 103/106 63mm		Roll	KE6330	10	£50.50
Marquette MAC PC	103mm x 23m	Roll	BR10823	10	£26.10
Marquette MAC 6/12/15	210mm x 280mm x 300p	Z-fold	MA210280P	10	£159.00
NK6511 6851	50mm x 20m	Roll	FUD5030	10	£37.80
NK5151	50mm x 30m	Roll	FUD5030	10	£37.80
NK6151	50mm x 75mm x 400p	Z-fold	FUD5075P	10	£50.50
NK8110	63mm x 75mm x 400p	Z-fold	NK6330	10	£50.50
NK9020	110mm x 140mm x 150p	Z-fold	NK110140P	10	£56.10
NK9130	210mm x 140mm x 200p	Z-fold	NK210140P	10	£82.70
NK9320		Z-fold	NK210300P	10	£159.00
Physio Control LP5	42mm x 25m	Roll	PC4216	10	£25.50
Physio C. LP4.6.7		Roll	PC4830	10	£43.10
Physio C. LP8.9.10		Roll	PC5020	10	£43.10

Your local medical supplier is just a phone call away. See cover for full details

Prices shown are exclusive of VAT and delivery

Dopplers Arterial Occlusive Disease Equipment

Bosch and Sohn (BoSo) ABI

System 100 – Saving lives through early detection of PAOD

Procedure
can be
undertaken by
non-qualified
individuals



The worlds first ABI system with many thousands of units in use in Germany the BoSo ABI 100 provides a completely new method of measuring the Ankle Brachial Index. A simple routine check with the BoSo 100 can help to save lives.

Peripheral arterial occlusive disease (PAOD) is often the forerunner of cardiovascular events with very serious consequences. Unfortunately even in high risk groups such as smokers, diabetics and the elderly, PAOD is often diagnosed too late with tragic personal consequences.

BoSo ABI calculates the crucial values quickly, precisely and reliably without the need for Doppler. All of BoSo's decades of experience manufacturing precision blood pressure measuring equipment is incorporated into the ABI 100 making it easy and very simple to use and understand.

Professional testimonies from well respected individuals such as Prof. Med. Curt Diehm, Head of Department, Internal and Vascular Medicine, Karlsbad-Langensteinbach Clinic, University of Heidelberg highlight the enormous advantages of the BoSo System 100

“ The innovative method used by the BoSo ABI-system 100 creates broad applications for ABI determination in medical practice because the test can be carried out in a few minutes without any special preparations. Doctors and patients alike benefit from this service spectrum, which makes possible accurate diagnosis and early targeted treatment. ”

After simple training the BoSo ABI System can be taking measurements in minutes and the supplied software has an internal database that offers patient management, graphic representation of measured values and a GDT interface that allows export to the practice data processing system.

The BoSo ABI 100 was designed to save lives – quickly, accurately and affordably.



The BoSo ABI 100 was designed to save lives – quickly, accurately and affordably.

466-0-141
BoSo ABI – System 100

£2595.00

Your local medical supplier is just a phone call away. See cover for full details

Prices shown are exclusive of VAT and delivery

Sonotrax Portable dopplers

The Sonotrax handheld doppler is ideal for routine examinations performed by Obstetricians and midwives. It is a high performance model with a digital fetal heart rate display. The Pro model can process FHR in 3 modes; real time FHR, Averaged FHR and manual mode whilst the STD model provides a simple manual heart rate mode. Both have audio output and can connect with earphones or recorder with audio input. The interchangeable probe is available in either 2,3,4 and 8MHz frequencies

Technical Specifications

LCD display:	45x25mm with backlit function
Ultrasound intensity:	< 10mW/cm2
FHR:	50-120bpm
Resolution:	1bpm
Power:	2 x AA with > 10hr continual use. Auto Off
Dimensions:	135x95x35mm
Weight:	circa 180g

ST0001 Sonotrax STD	£80.60
Sonotrax STD with manual heart mode	
ST0001pro Sonotrax PRO	£101.00
Sonotrax Pro with 3 heart rate modes	
SWDP-2MZ Additional probe for 2MHz dopplers	£59.00
SWDP-3MZ Additional probe for 3MHz dopplers	£59.00
SWDP-4MZ Additional probe for 4MHz dopplers	£59.00
SWDP-8MZ Additional probe for 8MHz dopplers	£59.00



Sonoline C

Designed for use in hospitals, clinics and for midwifery, the Sonoline C utilises a high resolution LCD and is able to show the FHR, waveform and calculate the FHR value.



Features

- Portable
- Simple operation
- Colour TFT LCD display 160x128 pixels
- Anatomically curved probe for easier administration
- Alarm of abnormal FHR
- Real time FHR display, averaged FHR and manual mode
- Battery status
- Headphone output
- Battery life > 8hrs

Performance

- Type B safety
- FHR range: 50 to 240bpm
- Accuracy +/- 2bpm
- Working frequency 2MHz +/- 10%
- 135 x 92 x 30mm
- Weight Circa 245g

ST0005	£141.80
Sonoline C fetal Doppler with 2Mhz probe	
SWDP-2MZ Additional probe for 2MHz dopplers	£59.00

Sonotrax HU

Specifically designed for home use by expectant women the Baby Sound range enables pregnant women to listen to their unborn babies heart beat and movements from as early as 10 to 12 weeks. Very simple to use. Whilst designed primarily for home use the quality of the Baby sound range makes it ideal for nurses and midwives who require a simple value for money doppler. The software allows the unit to be connected to a computer etc and allows the baby's heartbeat to be sent to friends and family via email



- 2 x AAA batteries provide for more than 6 hours continual use.
- Choice of audio output and Audio/Visual output

Specifications

- Integrated design helps protect sensitive doppler probe
- 2MHz frequency
- Double audio output sockets for headphones
- Output headset with volume control
- 110x55x16mm
- 80g with batteries
- Recording cable
- 1 year warranty
- Package contents include:
 - Baby sound doppler, headset, recording cable, instruction manual

75.00.000	£50.00	75.00.010	£70.40
Baby Sound doppler, basic model without FHR display		Baby Sound doppler with FHR display	
SWDP-2MZ Additional probe for 2MHz dopplers		£59.00	

Your local medical supplier is just a phone call away. See cover for full details

Prices shown are exclusive of VAT and delivery

Dopplers

UltraSound Technologies Pocket Doppler Range

British based manufacturers, Ultrasound Technologies, are pleased to offer their 'UltraTech' range of fetal and vascular Doppler systems for use in general practice and primary care. UltraTech units include a 3 year manufacturers

guarantee, proof of their reputation for quality and durability. High-quality surface mount electronics ensure excellent reliability.

From the basic PD1 pocket doppler, through to the combination and vascular units, all models are supplied with battery, canvas carry case and concise user guide.



UltraTech PD1 - Foetal Pocket Doppler



- Compact and lightweight pocket Doppler for routine antenatal foetal detection
- Ideal for use by general practitioner or midwife
- High-sensitivity 2MHz narrow-beam transducer
- Internal signal processing minimises noise artefacts
- Audio foetal heart signals are available via the built-in loudspeaker or optional headset
- Rotary volume control
- Easy to clean unit and transducer
- Powered by a standard 9v battery giving in excess of 9 hours continuous operation
- Battery saver system
- 3 year warranty

ULTRATEC PD1

UltraTech PD1 - Foetal Pocket Doppler

£168.00



UltraTech PD1+ - Foetal Pocket Doppler with FHR display

- The UltraTech PD1+ extends the standard features of the PD1, while still providing a small and lightweight device
- Built-in Foetal Heart Rate processing software (FHR)
- FHR information is displayed on the large LCD display for monitoring along with audio foetal heart signals
- FHR traces can be reproduced by connecting the built-in serial output to the optional UltraTrace 2 PC connection software
- Microprocessor controlled battery saver system
- 9v battery gives in excess of 6 hours continuous use
- 3 year warranty

ULTRATEC PD1+

UltraTech PD1+ Foetal Pocket Doppler with FHR display

£231.00

UltraTech PD1v - Vascular Pocket Doppler

- The UltraTech PD1v is a small, lightweight, high sensitivity pocket vascular doppler
- The vascular pencil probes are ideal for routine vascular examinations
- Vascular flow signals are easily detected using the lightweight narrow beam pencil transducer
- Internal signal processing minimises noise artefacts
- The flow signal is available to the user via the loudspeaker or optional headset, with rotary volume control
- Chart recorder output is provided for the printing of non-directional waveforms
- Available with the following narrow beam pencil transducer:
 - 8MHz - vessel location & pulse / systolic monitoring
- Velocity output
- Battery saver system gives in excess of 9 hours continuous use from a 9v battery
- 3 year warranty



ULTRATEC PD1V 8MZ

£399.00

UltraTech PD1v vascular Doppler with 8MHz pencil probe

ULTRA PD1CV 8MZ

£242.60

UltraTech PD1CV vascular Doppler with 8MHz standard probe

ULTRA PD1HEADSET

£26.60

Audio Headset for UltraTech Dopplers

Your local medical supplier is just a phone call away. See cover for full details

Prices shown are exclusive of VAT and delivery

UltraTech PD1combi - Combination Foetal and Vascular Doppler



- The more versatile option for General Practitioners involved in both foetal heart and vascular flow detection
- Small, lightweight and highly sensitive doppler device
- Built in loudspeaker with rotary volume control
- Monitoring also available via optional headphones
- PD1 combi is supplied complete with your choice of 1 of the following transducers:
 - 2MHz - routine antenatal foetal detection
 - 5MHz - routine vascular investigation
 - 8MHz - vessel location & pulse / systolic monitoring
- Additional probes are available as an option
- Easy to clean device and probes
- 9v battery (supplied) gives in excess of 9 hours continuous use
- 3 year warranty

ULTRA PD1COMB UltraTech PD1 combination Doppler with 2 Mhz probe	£260.00
ULTRA PD1COMB5MZ UltraTech PD1 combination Doppler with 5 Mhz probe	£260.00
ULTRA PD1COMB8MZ UltraTech PD1 combination Doppler with 8 Mhz probe	£260.00

ULTRATEC 2MZ PRO Additional 2 Mhz probe	£149.00
ULTRATEC 5MZ PRO Additional 5 Mhz probe	£149.00
ULTRATEC 8MZ PRO Additional 8 Mhz probe	£149.00

UltraTech PD1dwr - 'Water Birth' Foetal Doppler



- UltraTech PD1dwr incorporates all the features of the PD1+
- In addition, it provides General Practitioners and Midwives with a product suitable for 'water-birth' applications
- The 2MHz waterproof probe allows foetal signals to be located easily under water, whilst audio and foetal heart rate data are available in the normal way
- Allows complete immersion of probe for foetal assessment
- 3 year warranty

ULTRATEC PD1DWR UltraTech PD1 'Water-Birth' Foetal Doppler	£264.00
--	----------------

Your local medical supplier is just a phone call away. See cover for full details
Prices shown are exclusive of VAT and delivery

Spirometry & Respiratory Spirometers

Microlab Mk8 Spirometer

Latest generation Microlab spirometer featuring a high resolution colour touch screen. Printout is via the built in fast thermal printer or via USB to a separate Hewlett Packard printer (a list of compatible printers is available on request), giving an A4 full page report.

Key features of the Microlab Mk8 include:

- Hi-res colour touch screen with stylus
- On screen help function
- 2000 test memory
- Compact, lightweight device
- Fully configurable spirometry
- Gold standard accuracy from Micro Medical turbine flow sensor
- Real time display of Flow/Volume and Volume/Time curves
- Paediatric incentive screen
- USB and RS232 outputs for PC connection with Spirometry PC software
- Powered from mains 240v or internal rechargeable cell

OPTIONAL:

- Pulse Oximetry Module
- Packages including PC software



AWS-ML3500mk8

AWS-ML3500mk8	Microlab Mk8 Spirometer	£1399.00
W3500/13	Power adaptor for Mk8 Spirometer	£28.00
W3550/2	Charger for Mk8 Spirometer	£67.25

Please see pages 262 and 263 for our complete range of spirometry mouthpieces, filters and other accessories.

Your local medical supplier is just a phone call away. See cover for full details
Prices shown are exclusive of VAT and delivery

Spirometry PC Software

With Care Fusion Spirometry PC Software you can download and manage stored tests, perform tests in real-time on the PC and connect with your patient record system. Full details of Spirometry PC software can be found on page 160.

The following package includes the Care Fusion Microlab Mk8 and Spirometry PC software at a special price.

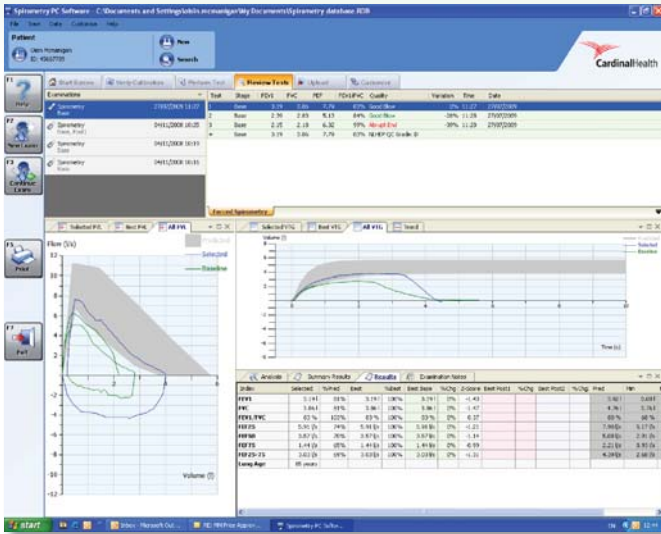

AWS-36-ML3500S-STK

Microlab with Spirometry PC Software

£1649.00



AWS-SP06000

Optional SpO2 module for Microlab Mk8

- SpO2 sensor plugs directly into Microlab Mk8 for measurement of arterial oxygen saturation
- Live tests can be viewed as plethysmograph or dual SpO2 / Pulse rate graph
- On screen colour warning symbols, indicate poor saturation levels and arterial artefacts

AWS-SP06000 Microlab Mk8 SpO2 Module

£286.60

Your local medical supplier is just a phone call away. See cover for full details

Prices shown are exclusive of VAT and delivery

Spirometry & Respiratory Spirometers

'Vitalograph is the world's leading provider of outstanding respiratory diagnostic, screening and monitoring devices. With a heritage spanning half

a century, Vitalograph continues to make pioneering contributions to effective respiratory care and enhanced quality of life'.

Vitalograph ALPHA Touch

Simple touch-screen spirometer with built-in printing and automatic PC connectivity.

The new generation Vitalograph ALPHA Touch is an easy to use, lightweight desktop spirometer that offers the benefits of portability, data integration and a built-in printer.



- Features a Fleisch Pneumotachograph, the best performing flow measuring technology in the world
- Simple icon driven menu with high resolution colour touch-screen
- Storage capacity for 10,000 subjects
- Automatic 2-way synchronisation of patient data and test sessions between ALPHA Touch and Spirotrac PC software
- Over 50 test parameters to choose from
- F/V and V/T curves viewable in real time
- Pre-post bronchodilator comparison
- Single or multi-breath
- % predicted or SDS scores comparison
- Hours of battery life for a full day off-site testing
- Choice of attractive incentive displays with sound effects
- Fully customisable reports including interpretation, BMI and lung age information

65502 Vitalograph ALPHA Touch **£1395.00**

65602 Vitalograph ALPHA Touch with Spirotrac V software **£1725.00**

Accessories for Vitalograph Alpha:

20242 Safe-T-Way one-way mouthpieces x 200 **£33.70**

20980 Mini Safe-T-Way one-way mouthpieces x 50 **£37.70**

20303 Disposable nose clips x 200 **£64.00**

66149 Thermal paper x 5 rolls **£89.00**

ASAF25 Anti-Bacterial Filters x 25 **£27.60**

63054 Serial spirometry record pads, 6 x 50 sheets **£89.00**

36020 3 litre precision syringe **£329.90**

Technical:

- Flow detection: Fleisch pneumotachograph, autoclavable
- Accuracy:
 - Flow; +/- 10% within correct operating temperature range
 - Volume; better than +/- 3%
- Operating temperature range:
 - ATS/ERS limits; 17-37°C
 - Design limits; 10-40°C
- Dimensions; 300 x 250 x 75mm
- Weight; 2kg net

Vitalograph Spirotrac V Software

Power and sophistication made simple.

Combines the power of your Windows PC and your network with Vitalograph's proven measuring technology for early detection of respiratory disease and improved management of COPD and asthma.

- Automative FEV1 trend chart of actual and normal range data as subject is selected
- Open session, F/V and V/T curves, all test data and test quality in one view
- Automatic storage of all test data and events, including calibration log
- Built-in test quality checks
- Choice of attractive on-screen incentives
- Comprehensive, configurable reports for spirometry sessions and trending
- Fully scalable database capacity using powerful Microsoft® SQL server technology

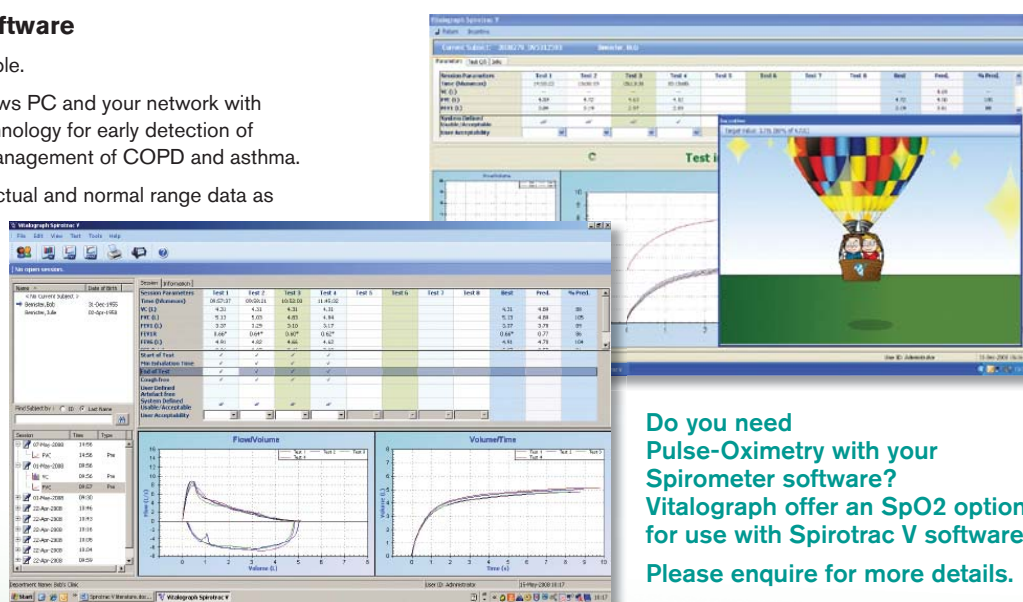

Do you need Pulse-Oximetry with your Spirometer software? Vitalograph offer an SpO2 option for use with Spirotrac V software. Please enquire for more details.

70200 Vitalograph Spirotrac V Software **£605.50**

89001 Vitalink for EMIS connectivity (per annum) **£154.00**

Your local medical supplier is just a phone call away. See cover for full details

Prices shown are exclusive of VAT and delivery

Vitalograph Alpha

- **Dedicated All-In-One Desktop Unit** – simple to operate with all controls at your fingertips
- **Bright Colour LCD Display** – results and settings can be seen clearly
- **Accurate** – Fleisch pneumotachograph testing system
- **Multiple Results Parameters** – including VC, FVC, FEV1, FEV1%, PEF, FEF25-75 and more
- **Best Test Selection** – automatically selects the best test for each patient session
- **On-Screen Curve Visualisation** – volume/time and flow/volume curves
- **Multiple Pre-Tests Stored** – for subsequent retrieval and post-testing
- **CompactFlash** – removable memory card slot
- **USB PC Connection** – with report generation software
- **Rechargeable Power System** – powered from mains or internal rechargeable cells
- **Fast, Silent Thermal Printer** – print up to 140 tests per roll
- **Calibration and Accuracy Tests** – includes a facility for accuracy testing
- **Package Includes** – Alpha device, stylish carry case, accessories and user manual
- **5 year warranty**

Technical:

- Flow detection: Fleisch pneumotachograph, autoclavable
- Accuracy:
 - Flow; +/- 10% within correct operating temperature range
 - Volume; better than +/- 3%
- Operating temperature range:
 - ATS/ERS limits; 17-37°C
 - Design limits; 10-40°C
- Dimensions; 300 x 250 x 75mm
- Weight; 2kg net



20242

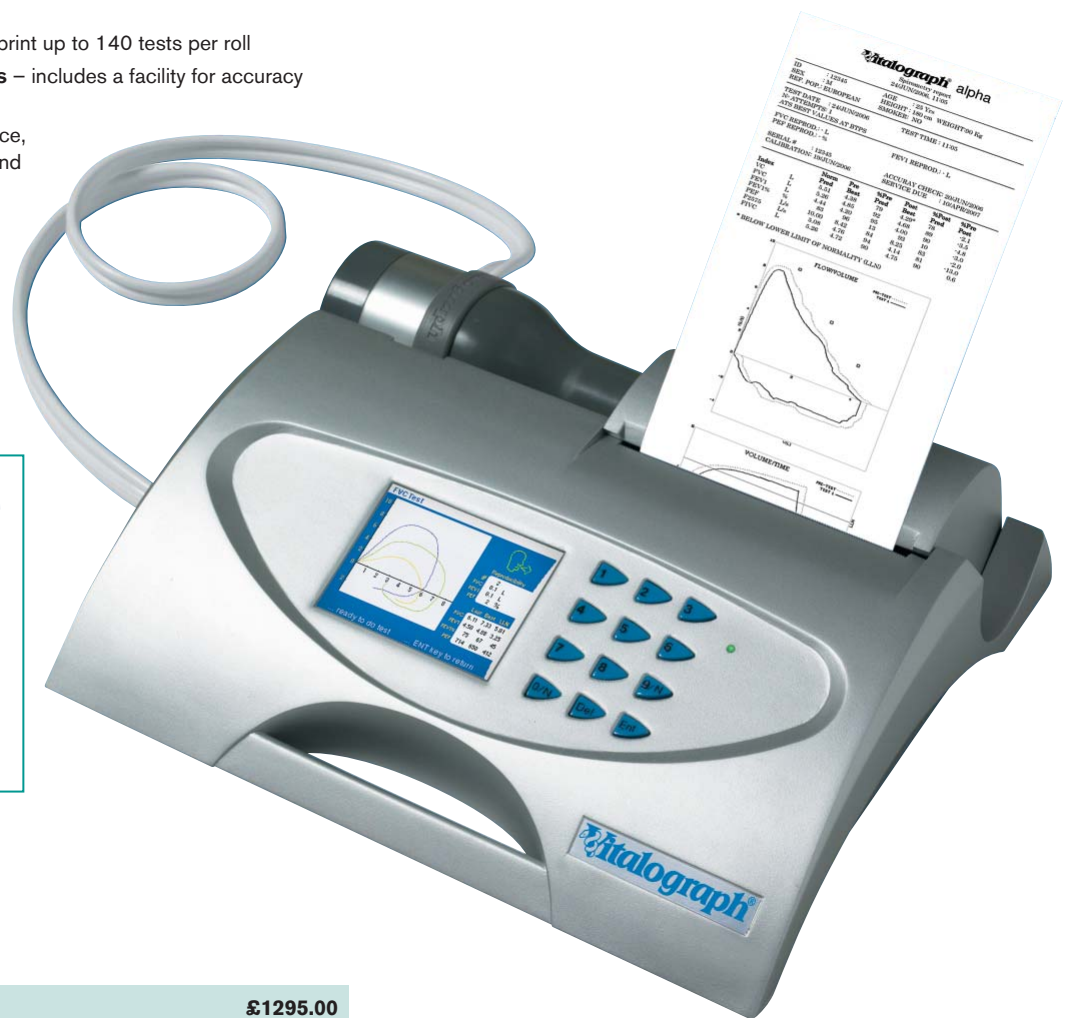

65002 Vitalograph Alpha **£1295.00**

Accessories for Vitalograph Alpha:

20242	Safe-T-Way one-way mouthpieces x 200	£33.70
20980	Mini Safe-T-Way one-way mouthpieces x 50	£37.70
20303	Disposable nose clips x 200	£64.00
66149	Thermal paper x 5 rolls	£89.00
ASAF25	Anti-Bacterial Filters x 25	£27.60
63054	Serial spirometry record pads, 6 x 50 sheets	£89.00
36020	3 litre precision syringe	£329.90



Your local medical supplier is just a phone call away. See cover for full details

Prices shown are exclusive of VAT and delivery

Spirometry & Respiratory Spirometers

MicroLoop Mk8 Spirometer

- **Next Generation Portable Spirometer** – incorporating the Micro Medical mark 8 touch screen with stylus
- **Hi-Res Display** – in full colour with user friendly icons
- **'Gold-Standard' Turbine Flow Sensor** – fast, accurate readings with no routine calibration requirement
- **Key Parameters Include** – FVC, VC, FEV1, FEV1%, PEF, F50, F25, MEF and more
- **Rechargeable** – with desk top docking station for charging and PC connection (using optional Spida 5 PC software)
- **Today's Test Feature** – builds a list of patient's to be tested that day

- **Estimated Lung Age**
- **Fast Text Entry** – with on-screen keys for data and comments
- **Printer Option** – can be connected to an external printer (details of compatible printers available on request)
- **Result Interpretation** – according to ATS, BTS-NICE or Enright
- **Bronchodilator and Steroid Assessment**
- **Body Mass Index and Dyspnoea Score**
- **Includes** – MicroLoop device, accessories and hard protective case



Spirometry PC software

Purchase the MicroLoop Mk8 complete with Spirometry PC software and make a **big saving** on the normal selling price.

AWS-ML3535mk8 MicroLoop Mk8 Spirometer **£1199.00**

AWS-ML3535mk8package **£1333.85**
MicroLoop Mk8 with Spirometry PC Software

Your local medical supplier is just a phone call away. See cover for full details
Prices shown are exclusive of VAT and delivery

Spirometry PC Software

The new Care Fusion Spirometry PC Software replaces Spida 5 and Spida Xpert, to provide the very best in PC connectivity and data management for the Microlab Mk8 and MicroLoop Spirometers.

Designed to meet the needs of the busy physician or healthcare provider, Spirometry PC Software uses a multi-window display which allows patients to be tested with the minimal number of steps – ease of use is key!

Tests are displayed in real-time, with clear colour coding of each blow. Results are displayed in a tabulated form which allows the user to customise the display to their own preferences. Powerful search facilities allows specific patient groups to be searched dependent on demographics or results. New and historical tests can also be viewed together and overlaid for comparison.

The Care Fusion Spirometry PC Software includes export capabilities to PDF, CSV, Excel and MS Word. It can easily be linked to patient clinical records systems, including EMIS and most mainstream EMR software (link licence fee may apply).

Features:

- Real-time display or from uploaded data sent from device
- Up to 50 spirometry indices, both inspiratory and expiratory
- Quality grading of blow performance
- Lung age calculation and interpretation
- Pre and post bronchodilator comparisons
- Choice of 4 animated incentive displays
- Fully configurable display and print formats
- Powerful trend function
- Fully ATS/ERS 2005 compliant
- Display of predicted values, % predicted and Z scores

Requirements: PC with 128MB RAM, 500MB free hard disk space, 2 x USB ports and running Windows 2000, XP or Vista.

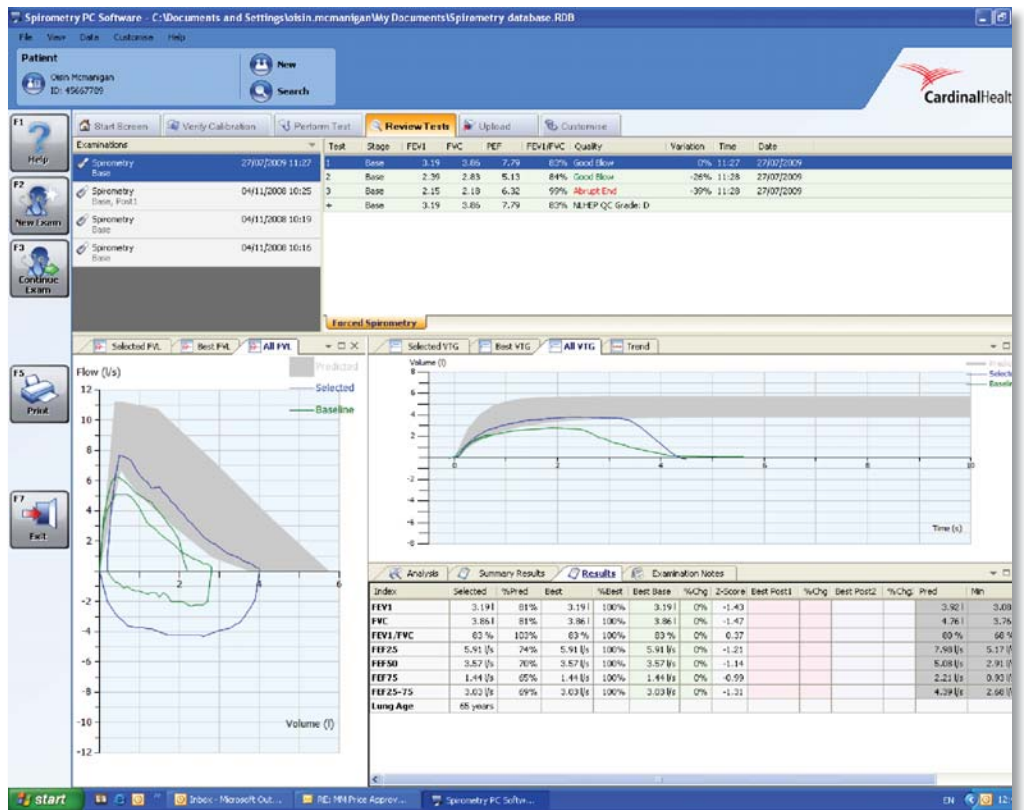
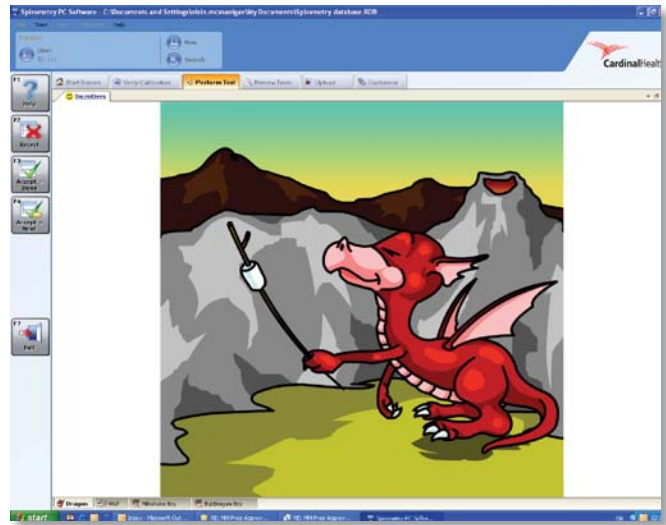

AWS-36-SPC1000	Spirometry PC Software	£427.00
AWS-36-SPCU1000	Spirometry PC Software upgrade from Spida	£173.40
AWS-36-SPC0105	Additional user license, each	£173.40
AWS-EMIS01-STK	EMIS link license (per annum)	£153.00
AWS-36-ML3500S-STK	Microlab with Spirometry PC Software	£1649.00
AWS-36-ML3535S-STK	MicroLoop with Spirometry PC Software	£1399.00

Your local medical supplier is just a phone call away. See cover for full details
Prices shown are exclusive of VAT and delivery

Spirometry & Respiratory Spirometers

Vitalograph In2itive Spirometer

For high quality spirometry on the move

Combines the benefits of full spirometry, data integration and mobility in a small lightweight handheld spirometer

- Storage for 10,000 subjects
- Subject data from Spirotrac V may be downloaded automatically – saving time and eliminating data entry errors
- Session can be automatically transferred to and synchronized with Spirotrac V

- Colour touch-screen
- Long battery life, for a full days off-site testing
- 62 test parameters
- Choice of child incentives with sound effects
- Remote flowhead option enables the subject to view incentives while performing the test
- Print via your PC (using Spirotrac V or Vitalograph Reports software) or print direct to USB printer (using printer cradle)



79002	£1395.00
Vitalograph In2itive with Spirotrac V software	
79402	£1195.00
Vitalograph In2itive with Vitalograph Reports software	
79302P	£1495.00
Vitalograph In2itive with cradle and A4 printer	

Your local medical supplier is just a phone call away. See cover for full details

Prices shown are exclusive of VAT and delivery

Vitalograph Pneumotrac USB

- **Pneumotrac USB** – for the long-term storage of spirometry results
- **Unparalleled Accuracy** – from the Fleisch pneumotachograph system
- **Spirotrac® Software:**
 - Sophisticated, adaptable, interactive, user friendly
 - Exportable data to any spreadsheet, database or word processor application
 - Network ready, standardised communication with other databases
- Clinical system compatible including Vision and EMIS (please call for details)
- Storage and trending of test results
- **5 year warranty**
- **Package Includes** – Pneumotrac device, USB cable and docking station, Spirotrac® software and user manual

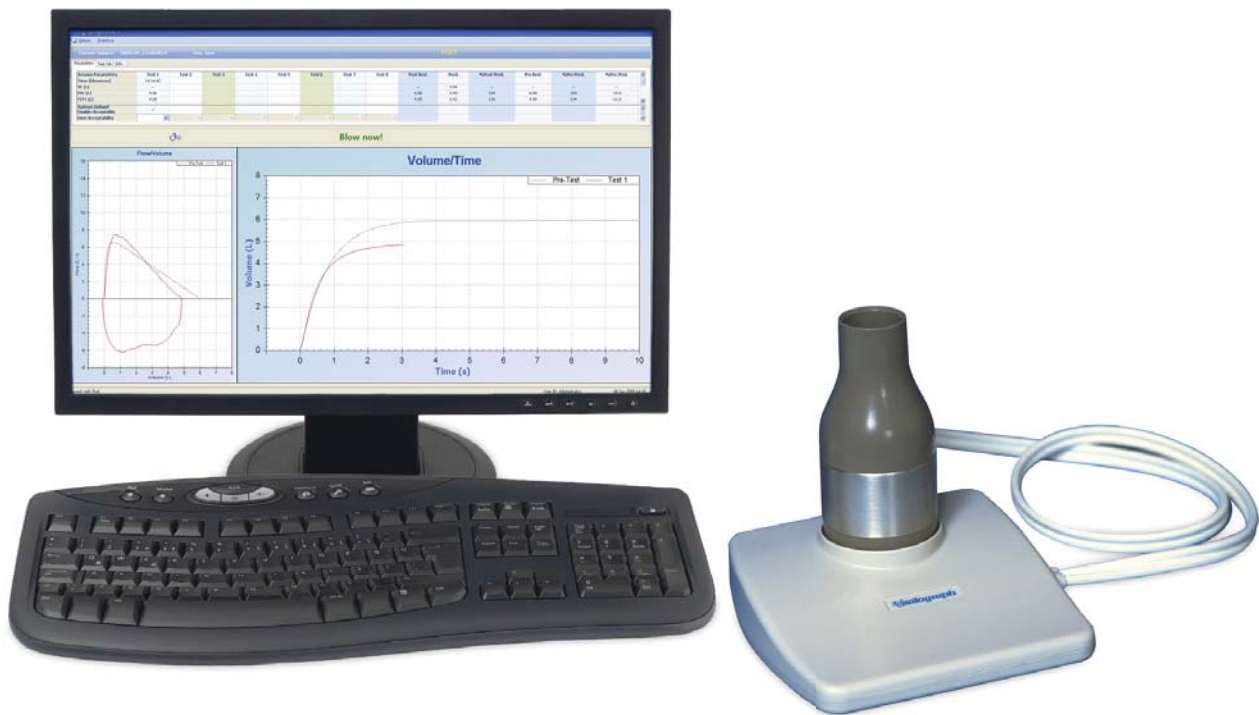

20242

77002 Vitalograph Pneumotrac USB **£1275.00**

Accessories for Vitalograph Pneumotrac USB and COPD6:

20242	Safe-T-Way one-way mouthpieces x 200	£33.70
20980	Mini Safe-T-Way one-way mouthpieces x 50	£37.70
20303	Disposable nose clips x 200	£64.00
ASAF25	Anti-Bacterial Filters x 25	£27.60
36020	3 litre precision syringe	£329.90

Your local medical supplier is just a phone call away. See cover for full details

Prices shown are exclusive of VAT and delivery

Spirometry & Respiratory Spirometers

SpiroUSB

A revolutionary new spirometer that plugs directly into the USB port of your PC, without the need for an additional docking station. With a Laptop or Notebook, SpiroUSB becomes highly portable too!

Spiro USB allows fully featured PC based spirometry in three easy steps:

- 1 Plug the transducer into your computer to automatically launch Spirometry PC Software
- 2 Click the 'New Examination' button
- 3 Blow into SpiroUSB and view results on the PC screen

- Precision Micro Medical 'Gold Standard' transducer
- Modern USB interface
- Spirometry PC spirometry software included
- Measurement of up to 41 parameters – user selects those required
- Configurable printout format
- No batteries required – powered directly via PC
- For more features see the 'Spirometry PC Software' section
- Please note - PC not included



AWS-ML2525

£1099.00

Vitalograph Micro

- **Pocket Spirometer** – with PC connection
- **Measurable Parameters** – FVC, FEV1, FEV1%, PEF and more
- **Great Value** – low cost, reliable and robust
- **Accurate** – Fleisch type flow sensor with calibration and accuracy test facility
- **PC Connection** – complete with 'Vitalograph Reports' PC software for printing and PDF production of results
- **Report Includes:**
 - Flow/volume curve
 - Volume/time curve
 - Test quality report
 - Interpretation report
 - Predicted values
- **High Visibility LCD Display** – with large numerals and icons
- **Battery Operated**

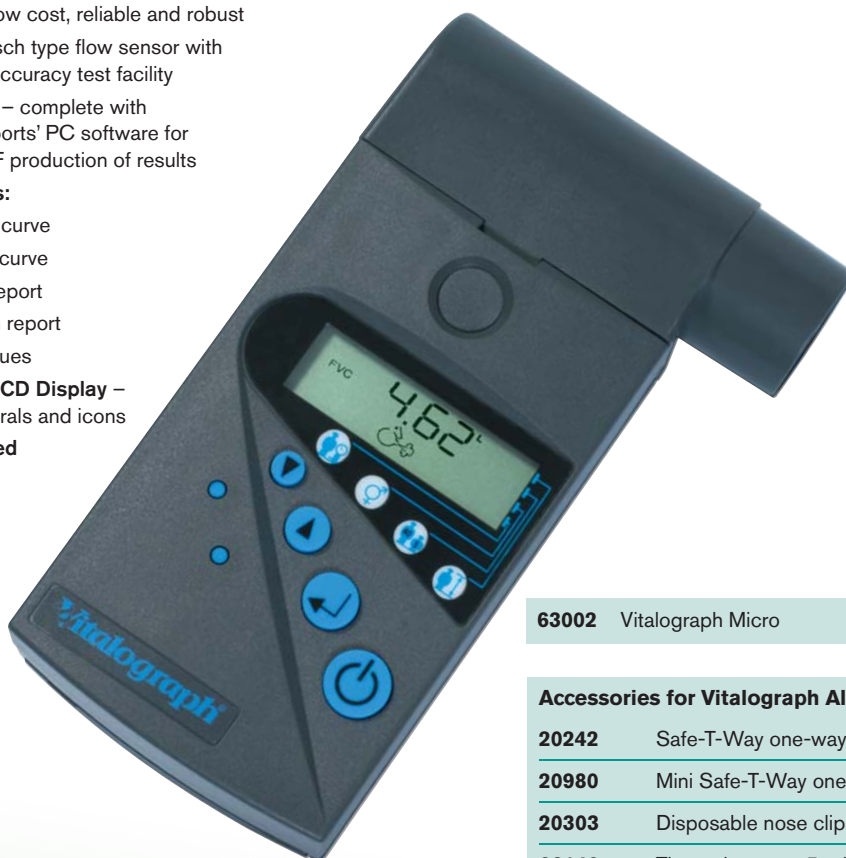

63002 Vitalograph Micro

£525.00

Accessories for Vitalograph Alpha:

20242	Safe-T-Way one-way mouthpieces x 200	£33.70
20980	Mini Safe-T-Way one-way mouthpieces x 50	£37.70
20303	Disposable nose clips x 200	£64.00
66149	Thermal paper x 5 rolls	£89.00
ASAF25	Anti-Bacterial Filters x 25	£27.60
63054	Serial spirometry record pads, 6 x 50 sheets	£79.60
36020	3 litre precision syringe	£329.90

Your local medical supplier is just a phone call away. See cover for full details

Prices shown are exclusive of VAT and delivery

Micro 1 Spirometer

Portable handheld spirometer with predicted values, quality assessment of blows and optional NLHEP mode. Designed for quick and easy testing of patients the unit is ideal for general practitioner and private doctors offices, outpatient hospital departments,

Specifications

- MEASUREMENTS: FEV1, FEV6, FVC, FEV1/FEV6, FEV1/FVC, PEF, FEF25-75, FEF75, FEF25
- Volume Range: 0.1 to 8L (Gold Standard Turbine 0.1 to 9.99L)
- Flow Range: 0.2 to 15 L/s
- Accuracy: $\pm 3\%$ to ATS Recommendations
- Display: 128 x 128 pixel graphic backlit monochrome LCD
- Battery life: Approximately 30 hours with a fully charged battery
- Power Supply: Input: 100-240V AC 50-60Hz 0.5A Output: 5V 1.2A
- Dimensions: 6.4in x 2.4in x 1.2in (162cm x 61cm x 30cm):
- Weight: 0.33lbs (152g)
- Operating Temperature: uniform environment of 10°C - 35°C, out of direct sunlight
- Operating Humidity: 20-80% RH
- Storage Temperature: -20°C to +70°C
- Storage Humidity: 30-90% RH
- Requirements: An IBM-compatible PC is required, with hardware that meets or exceeds the following minimum requirements.

PC configuration

- Processor: 800 MHz or above RAM: 256 MB
- Free Disk Space: 50 MB
- At least one free USB port

Operating System Requirements

- Windows XP / 7
- Windows Vista 32bit
- Windows Vista 64bit
- Windows Server 2003
- Windows Server 2008

occupational health settings, heart – lung transplantation units, and COPD patients where devices can be taken away by the patient for self testing and health surveillance management.

- Choice of 4 indices can be displayed
- ATS/ERS 2005 Quality prompts for each manoeuvre
- NLHEP configuration mode
- Current manoeuvre and Best manoeuvre available for viewing
- Quick examination option for quick patient testing
- Predicted values displayed as either % predicted or z score
- Post bronchodilator option with % change displayed
- Remembers the last patient tested to allow testing to continue
- Calibration check to verify device
- Last calibration check can be viewed
- Choice of 10 languages can be selected
- PC software for configuration of device
- Small portable and lightweight
- High definition backlit display
- Flat touch keypad
- Rechargeable battery (charger supplied in carry case with unit)
- Easily customised for regional settings



36-MS10-STK

£313.95

Your local medical supplier is just a phone call away. See cover for full details

Prices shown are exclusive of VAT and delivery

Spirometry & Respiratory CO Monitors

Compact Smokerlyzer



Accessories for Compact, Pico+ and Micro+ Smokerlyzer:

D-Piece £26.10

D-Piece one-way anti-bacterial filter, fits Compact, Pico+ and Micro+ Smokerlyzers and is used with flat pack cardboard tubes (change monthly), pack 12

AWR-142.0040 £25.50

Cardboard mouthpieces, fits D-piece on Compact, Pico+ and Micro+ Smokerlyzers, pack 125

- **Carbon Monoxide Tester** – a useful assist for health professionals in smoking cessation programmes
- **Low Cost and Easy-to-Use** – a simple device that can provide compelling results
- **7 Level Indicators** – with familiar green, amber, red traffic light system
- Suitable for:
 - General Practice
 - Schools
 - Pharmacies
 - Health visiting services
- **First Point Testing** – prior to referral to a specialised stop-smoking service

AWR-BCS01 Compact Smokerlyzer **£76.50**

Micro+ Smokerlyzer

- **The Most Comprehensive CO Monitor** – with the ability to analyse breath samples for adults and adolescents
- **Automatic Conversion to Foetal %COHb** – simple one-touch control
- **Chart Progress** – through the quitting process
- **Motivational Tool** – to assist in smoking cessation programmes and to highlight the dangers of smoking in pregnancy
- **Custom Profiles** – for smokers who are difficult to motivate
- **Clear Colour LCD Display** – with touch-screen controls
- **View Results on Screen** – in a graph or table format
- **Internal Memory** – for up to 10 patient with results
- **Package Includes** – Micro+ Smokerlyzer, canvas carry bag, 10 D-pieces, 50 cardboard mouthpieces, Codata+ software, batteries and instruction manual

Features:

- Readings are available in COppm and %COHb, instantly converted to foetal %COHb
- Adjustable breath-hold timer for patients unable to hold their breath
- Adult, adolescent and custom profile settings
- Low sensitivity to hydrogen and alcohol – ensures accuracy of results
- Anti-bacterial filter and one-way valve for improved infection control
- Built in maintenance reminders

Benefits:

- Low-cost, quick and reliable testing
- The only monitor you will need for all your testing needs
- Instant results indicator with green, amber, red traffic light system
- Easy to calibrate, even by non-technical staff
- Maximum reading held on display

Technical:

- Concentration range: 0 – 250 ppm (in 1 ppm increments)
- Detection principle: electrochemical sensor
- Accuracy: +/- 2%
- Batteries: 3 x AA (LR6) alkaline
- Operating temperature: 0 – 40°C
- Sensor life: 2-5 years (6 month warranty)
- Warranty: 2 years
- Dimensions: 44 x 77 x 138mm
- Weight: 250g



'Calibration Gases are available on request'



AWR-BM+01 Micro+ Smokerlyzer **£385.70**

Accessories for Compact, Pico+ and Micro+ Smokerlyzer:

D-Piece £26.10

D-Piece one-way anti-bacterial filter, fits Compact, Pico+ and Micro+ Smokerlyzers and is used with flat pack cardboard tubes (change monthly), pack 12

AWR-142.0040 £25.50

Cardboard mouthpieces, fits D-piece on Compact, Pico+ and Micro+ Smokerlyzers, pack 125

Your local medical supplier is just a phone call away. See cover for full details

Prices shown are exclusive of VAT and delivery

Micro CO Monitor

- Designed specifically for use in smoking cessation programmes
- Also used in CO poisoning and smoke inhalation screening
- Measures Carbon Monoxide in PPM and %COHb
- Coloured light indicators:-
Green = 0-6ppm; Yellow = 7-10ppm; Red = 11+ppm
- Can be interfaced with COBRA Windows® software
- Audible warning tone for high CO levels
- Breath hold countdown timer for more accurate assessment
- Auto zero facility
- Small, lightweight and portable in a sturdy carry case
- Calibration kit available
- Easy to use, clean and maintain



AWS-MC02 Micro CO Monitor	£257.25
CB1000 COBRA Windows® software	£45.90

36-MCGK020 Calibration Kit for Micro CO Monitor	£73.00
PSA1200 Mouthpieces for Micro CO monitor, pack 250	£22.50

pico+ Smokerlyzer

- Benchmark CO2 Monitor** – used worldwide in smoking cessation programmes and clinical trials
- Most Cost-Effective Option** – for motivational CO monitoring
- Profile Settings** – for adult smokers, child smokers and pregnant women
- Large LCD Display** – showing single ppm, %COHb, traffic light display and smoking status
- Ideal for Smoking Cessation Groups and Clinics** – to demonstrate levels of CO and reduction in CO
- Package Includes:**
 - Pico+ Smokerlyzer
 - Codata+ software
 - Carry case
 - D-piece
 - 10 x Steribreaths
 - 1 x pack of wipes



Benefits:

- Motivates the smoker to stop
- Low maintenance costs
- Supported by a wide range of stop smoking resources
- Can be used to screen for CO poisoning and smoke inhalation
- Compatible with COdata+ software – for database building and to personalise settings

Features:

- Easy to read, with instant results
- Auto-zero and breath hold countdown timer
- Anti-bacterial filter and one-way valve for improved infection control
- Can be calibrated by non-technical staff

Technical:

- Concentration range: 0 – 80 ppm (in 1 ppm increments)
- Detection principle: electrochemical sensor
- Accuracy: +/- 2%
- Batteries: 2 x AA (LR6) alkaline
- Operating temperature: 0 – 40°C
- Sensor life: 5 years
- Warranty: 2 years
- Dimensions: 45 x 75 x 120mm
- Weight: 200g

'Calibration Gases are available on request'



Accessories for Compact, Pico+ and Micro+ Smokerlyzer:

D-Piece D-Piece one-way anti-bacterial filter, fits Compact, Pico+ and Micro+ Smokerlyzers and is used with flat pack cardboard tubes (change monthly), pack 12	£26.10
---	---------------

AWR-142.0040 Cardboard mouthpieces, fits D-piece on Compact, Pico+ and Micro+ Smokerlyzers, pack 125	£25.50
--	---------------

AWR-BP+01 pico+ Smokerlyzer	£196.40
------------------------------------	----------------

Your local medical supplier is just a phone call away. See cover for full details

Prices shown are exclusive of VAT and delivery

Spirometry & Respiratory Inhaler Accessories

Vitalograph PEF asmaPLAN+

- **Best Value Peak Flow Meter** – in the UK
- **Accurate** – from market leaders Vitalograph
- **Compact, Lightweight & Portable** – practical for home use
- **Robust & Hardwearing** – suitable for clinical use
- **Integral Mouthpiece** – comfortable
- **Suitable For All Ages** – no need for a low-range device
- **Suitable For Multi-Subject Use** – with Safe-T-Way mouthpieces
- **Conforms to EN13826:2003** – and all other peak flow standards
- **Complies to** – National Asthma Campaign, NAEP and international guidelines on asthma self management
- **Unique Features:**
 - patented dual colour sliders
 - follow the management colour zones set by the healthcare professional
 - typical settings:
 - red zone > 60% of best PEF
 - yellow zone > 80% of best PEF
 - green zone > 100% of best PEF

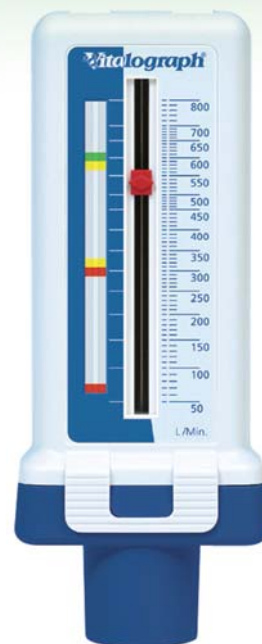

43602 Vitalograph asmaPLAN+

£6.20



Flutter

- **For Sufferers of Chest Congestion** – helps relieve mucus congestion in the small airways, when used regularly
- **Vibratory Action** – loosens mucus to help clear obstructions
- **For Sufferers of** – Chronic Bronchitis, Bronchiectasis, Emphysema, Asthma and Cystic Fibrosis
- **Useful Assist to Physiotherapy**
- **Easy To Clean** – palm size, dismantles easily and autoclaveable
- **Includes** – Flutter device and full user instructions

310.2000 Flutter

£66.75

Able Spacer

- **Discreet, Compact Small Volume Spacer** – improves inhaler technique for both adults and children
- **Reduces Velocity** – of the aerosol and subsequent impact on the oropharynx
- **Improves Performance** – larger proportion of aerosol particles can be inhaled
- **Coaching Signal** – helps patient maintain proper inhalation rate for maximum drug delivery
- **Suitable for Tidal Breathing** – silicone valve prevents exhaled air from entering the chamber
- **Universal** – accommodates most metered dose inhalers
- **Inhaler Storage** – store inhaler inside when not in use
- **Choice of Masks** – small, medium and large silicone face masks available (optional)



Space Chamber

- **Improves Inhaler Use** – exact timing is not required
- **Spacer Device** – improves particle size for more efficient performance
- **Traps Large Particles** – to help prevent irritation of the mouth and throat

360.5490 Able Spacer - UK

£19.40

360.7005 Small Mask

£5.30

360.7006 Medium Mask

£5.30

360.7007 Large Mask

£5.30

370.1000 Space Chamber

£10.10

370.1001 Space Chamber, with O2 port

£16.00

Your local medical supplier is just a phone call away. See cover for full details

Prices shown are exclusive of VAT and delivery

Vitalograph COPD6

- Identify Potential Cases of COPD, Early



- **COPD6** – revolutionary COPD screener
- **Pre-Symptomatic Screening** – for early detection of cases
- **No False Negatives** – screens out those whose FEV1 is normal and as such do not have COPD
- **Key Parameters Displayed** – obstructive index and COPD classification (stage I – IV) for interpretation
- **Other Parameters Displayed** – FEV1, FEV6, ratio, % predicted and lung age
- **Easy To Use** – simple operational controls
- **Detachable Flowhead** – rotor type, easy to clean
- **Quality-of-Blow Indicator**
- **Large LCD Display** – with icons that are easy to read
- **Suitable for Multiple Subjects**
- **Printer Version** – available with output for printer connection

40200	Vitalograph COPD6, USB version	£135.00
40200P	Vitalograph COPD6, printer version	£153.00

In-Check Dial

- **Inhaler Training Device** – mimics the resistance of popular inhalers to familiarise the patient and improve performance
- **Improved Efficiency** – achieving the optimum inspiratory flow significantly increases the amount of drug deposited in the lungs
- **Identifies Incorrect Technique**
- **Compare Optimum Results** – with reference card provided, for most popular inhaler devices
- **Calibrated for Maximum Accuracy** – when measuring inspiratory flow between 15 to 120 lpm



310.9760	In-Check inhaler assessment kit	£43.00
310.9751	In-Check Nasal, with medium mask	£26.60
310.9753	Medium face mask for in-check nasal	£5.70
310.9756	Small face mask for in-check nasal	£5.70

PulmoLife



“Every GP should have one!”

What is it for?

- Quick and simple COPD screening in adult smokers
- Perfect for the Doctor's room/bag for deciding when full spirometry is required
- Encouraging patients to stop smoking

What results does it give?

- FEV1 – the measurement of choice in COPD screening
- % Predicted FEV1 – how do patients compare to normal values?
- Lung Age interpretation – meaningful and powerful information for the patient
- Visual image of a smoker - helps the patient realise the physical damage caused by smoking

Why use it?

- To save you time by quickly highlighting patients requiring a full spirometry test
- Accurate, reliable, low cost
- Every GP should have one!

PulmoLife	£120.00
------------------	----------------

Your local medical supplier is just a phone call away. See cover for full details

Prices shown are exclusive of VAT and delivery

Spirometry & Respiratory Peak Flow

Mini-Wright Digital

- Latest addition to the Mini Wright Range – the name speaks volumes
- Measures PEF and FEV1 – for both asthma and COPD patients
- Zoning Function – red, yellow and green zones for percentage of best PEF achieved
- Customisable – zoning function can be set for personal asthma management
- 200 Test Memory – for review and trend analysis
- Waterproof – allowing surface sterilisation / disinfection
- Optional:
 - PC Connection / Download

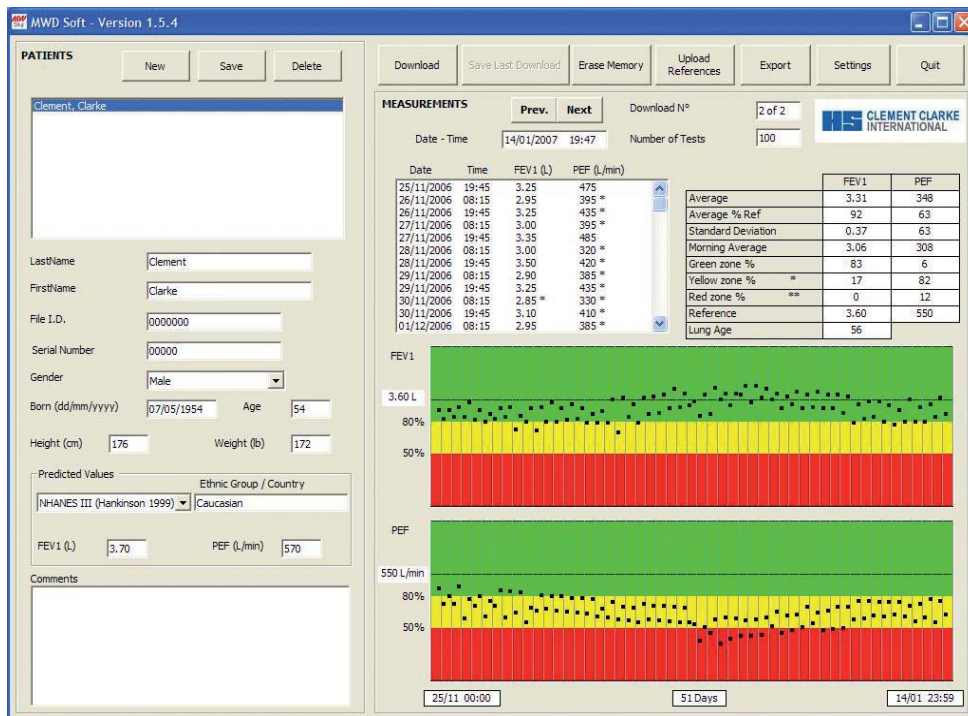

AWS-MWD	Mini-Wright digital	£26.10
AWS-MWDPC	Cradle and PC software	£62.50

Your local medical supplier is just a phone call away. See cover for full details
 Prices shown are exclusive of VAT and delivery

Mini Wright's Peak Flow Meter

- The original Mini Wright's peak flow meter, available in standard and low range versions
- Each unit is calibrated to ensure consistent accuracy levels
- Standard measures PEF from 60 - 800 lpm
- Low range measures PEF from 30 - 400 lpm
- Integral non-return valve for hygienic protection
- Includes sterilisable mouthpiece, instructions and patient record chart
- Mouthpiece diameter 22mm, all types
- New European standard



AWS-MW10 Mini Wrights Peak Flow Meter, standard range	£9.50
AWS-MW20 Mini Wrights Peak Flow Meter, low range	£9.50

AWS-D110 Disposable mouthpieces adult, box 500	£19.40
AWS-D120 Disposable mouthpieces paediatric, box 100	£9.20

Peak Flow Mouthpieces:



20242 Safe-T-Way one-way mouthpieces x 200	£33.70
20980 Mini Safe-T-Way one-way mouthpieces x 50	£39.00
PSA1000 Mouthpieces, universal fit, box 500	£29.60

Vitalograph asma-1 Electronic Asthma Monitor



The Vitalograph asma-1 is an easy to use, yet sophisticated, electronic asthma monitor. Monitoring asthma is now simpler and more accurate than ever before – by measuring FEV1 as well as peak flow, asma-1 gives a clearer picture of lung health.

- **Large LCD Display** – clear and easy to read
- **Stores up to 600 Test Sessions** – for review and trend analysis
- **Clearer Picture of Lung Health** – by comparing FEV1 with PEF
- **Simple and Accurate** – better than ever before
- **No Need for Record Cards**
- **Test Quality Indicator**
- **Suitable For Multi-Subject Use** – with Safe-T-Way mouthpieces
- **Battery Powered** – from AAA batteries

05992 asma-1 Asthma Monitor	£47.85
---------------------------------------	---------------

Your local medical supplier is just a phone call away. See cover for full details
Prices shown are exclusive of VAT and delivery

Spirometry & Respiratory Spirometry Consumables

Spirometry Consumables

Mouthpieces

Spirometer mouthpieces are available with or without a one-way valve and can be used with an optional anti-bacterial / viral filter. Your choice of mouthpiece will decide the level of protection, for patient and machine. All mouthpieces and filters are a universal fit for all devices.

1. Normal Mouthpiece = NO protection

Your flow sensor will need to be sterilised between patients, taking valuable time (turbine sensors need to dry naturally at room temperature). You will need to use a cold sterilant such as Perasafe.



PSA1000	Mouthpieces, Micro Medical, box 500	£29.60
AWS-D110	Mouthpieces, universal fit, adult, box 500	£19.40
AWS-D120	Mouthpieces, universal fit, paediatric, box 100	£9.20

2. One-Way Mouthpiece = GOOD protection

One-way mouthpieces are used instead of a normal mouthpiece and prevent inhalation so contaminants and particles cannot be drawn back towards the patient. In turn, these mouthpieces prevent inspiratory testing. You should still sterilise the flow sensor on a regular basis.



20242	Safe-T-Way one-way mouthpieces x 200	£33.70
20980	Mini Safe-T-Way one-way mouthpieces x 50	£39.00
SST1000	One-way safety mouthpieces x 500	£81.10

3. Anti-Bacterial / Viral Filter = EXCELLENT protection

These filters are used with a normal mouthpiece and stop particles traveling between the patient and the flow sensor and back again. These provide the best protection and are the fastest option in clinical use. They can also be used for both expiratory and inspiratory testing.



ASAF25	Anti-Bacterial Filters x 25	£27.60
ASAF100	Anti-Bacterial Filters x 100	£91.80
ASAF200	Anti-Bacterial Filters x 200	£173.40



Papers

MIR - Spirolab I, II and III

910350/10MT	10 mtr Roll for Spirolab Machines	£3.50
--------------------	-----------------------------------	--------------

Vitalograph - Alpha and Compact

66149	Pack of 5 rolls	£89.00
--------------	-----------------	---------------

Micro Medical – Microlab and Microlab Mk8

PSA1600	Pack of 5 rolls	£29.60
PSA1600/10	Pack of 10 rolls	£55.10

Perasafe

- Perasafe 81g Container, makes up to 5 litres of sterilising solution. Also available in 16.2g sachets, 162g and 810g containers
- Procedure:
 - Mix the required solution
 - Immerse the flow sensor in the solution for the stated time
 - Remove flow sensor and immerse in clean demineralised water
 - Allow to dry at room temperature



SSC5000	Perasafe 81g	£11.80
SSC5000/16.2/10	16.2g sachets x10	£29.60
SSC5000/16.2/100	16.2g sachets x100	£281.50

Nose Clips



Vitalograph Single-Use

20303	Disposable, pack of 200	£69.00
--------------	-------------------------	---------------

Your local medical supplier is just a phone call away. See cover for full details

Prices shown are exclusive of VAT and delivery

Guardian Spirometer Spares and Accessories

Our Guardian generic range of spirometer spares and accessories, offers all the performance and function you would expect with considerable savings over alternative 'branded' parts. Choose from a full range of mouthpieces, with and without one-way valves in adult and paediatric sizes, antibacterial filters for complete protection against cross-contamination, papers to fit all machines and nose-clips.

Paediatric Mouthpieces:

180.10.000/100 cardboard without filter x 100	£7.20
180.12.000/100 with one-way filter x 100	£18.00
180.30.000 Paed Adaptor (use with 180.10.000 / 180.12.000), each	£0.30
180.30.000/20 Paed Adaptor (use with 180.10.000 / 180.12.000), x 20	£3.60

Adult Mouthpieces:

180.20.000/100 Cardboard without filter x 100	£4.10
180.20.000/500 Cardboard without filter x 500	£16.10
180.22.000/100 with one-way filter x 100	£12.30
180.22.000/500 with one-way filter x 500	£52.28
180.26.000/100 One-way valve only adult (for use with 180.20.000) x 100	£10.20
180.26.000/500 One-way valve only adult (use with 180.20.000) x 500	£29.95

Antibacterial Filters:

180.28.000/10 Antibacterial filter x 10	£9.20
180.28.000/25 Antibacterial filter x 25	£20.40
180.28.000/100 Antibacterial filter x 100	£81.30

Nose Clips:

20303G Nose-clips, pack of 5	£1.30
--	--------------



Your local medical supplier is just a phone call away. See cover for full details

Prices shown are exclusive of VAT and delivery

Spirometry & Respiratory Oxygen Concentration

DeVilbiss Compact 5 Oxygen Concentrator

The Compact 5 delivers a constant uninterrupted supply of Oxygen to the user, immediately at the simple push of a button. Oxygen is separated from other gases within the air and delivered in a high concentration to the patient. Compact 5 does not effect the levels of Oxygen within the surrounding air. Key features include:

- High oxygen concentration levels across the whole flow range
- Maximum and variable flow of up to 5 l/pm
- OSD sensor continuously monitors oxygen levels
- Visual and audible alarms for low Oxygen levels, power failure, pressure drop and service intervals
- Easy to operate
- Solid, robust design
- Moulded handgrip for easy transportation and roller base for easy manoeuvrability
- Easy view hour meter
- Paediatric flowmeter option (please call for details)
- Take away bubble humidifier
- Low noise operation
- Dimensions 70 x 41 x 36cm
- Weight 24.5kg

Specifications

- 1 to 5 l/pm flow rate
- Concentration 93%, +/- 3%
- Noise level 50dBa
- Power consumption 365 watts



COMPACT 5 Compact 5 Oxygen Concentrator **£995.00**

AirSep Intensity 10 Conventional Oxygen Concentrator - 10 litre

This power efficient concentrator combines high pressure with high flow.

- Up to 10 litres per minute
- Operates up to 590 Watts for reduced power consumption
- Designed to be used in conjunction with large volume jet nebulizers, venti-masks, medication nebulizers and long oxygen tubing runs
- Single or dual flow (for two patients)
- Low flowmeter blocks for paediatric and other low flow applications
- Oxygen Concentration - 2 – 9 LPM: 92%±3; 10LPM: 90%±3
- Oxygen outlet pressure – 20psig (138 kPa)
- H x W x D: 699 x 419 x 368mm
- Weight – 26.3kg
- Power – 120V, 60Hz; 220 – 240V, 50Hz
- Alarms – Battery test, high temperature, power failure, high and low pressure, low concentration (with optional oxygen monitor)



115000 AirSep Intensity 10 Concentrator **£1800.00**

Your local medical supplier is just a phone call away. See cover for full details

Prices shown are exclusive of VAT and delivery

Oxygen Mask (Medium concentration)

- Flexible and comfortable oxygen mask designed for convenient oxygen therapy
- Mask moulded from non toxic medical grade PVC
- Adjustable strap for proper positioning of mask
- Swivel connector
- 210cm (7ft) multichannel tube
- Funnel connectors
- Individually packed
- Adult and Child versions
- Master box of 50



GS2020/0 Adult medium concentration oxygen mask	£1.50
GS2020/1 Child medium concentration oxygen mask	£1.50

GS2020/0/50 Master box of 50 Adult medium concentration oxygen masks	£58.50 (£1.17 ea)
GS2020/1/50 Master box of 50 Child medium concentration oxygen masks	£58.50 (£1.17 ea)

Oxygen Mask (Variable Venturi System)



- Provides accurate concentrations of oxygen
- Transparent mask with soft anatomical form and easily adjustable strap
- Rotating connector selects according to set flow rates and percentage concentration required
- Flow Rate 6 litres per minute
 - 35%
 - 40%
 - 60%
- Flow Rate 3 litres per minute
 - 24%
 - 26%
 - 28%
 - 31%
- Unique spring loaded mechanism locks prescribed concentration level in place ensuring safety and correct oxygen concentrations
- 210cm (7ft) multichannel tube
- Non Sterile individually packed
- Master box of 50
- Adult and child versions

GS2038/0 Adult variable flow oxygen mask	£2.10
GS2038/1 Child variable flow oxygen mask	£2.10

GS2038/0/50 Master box of 50 Adult size variable concentration oxygen masks	£94.10 (£1.88 ea)
GS2038/1/50 Master box of 50 Child size variable concentration oxygen masks	£94.10 (£1.88 ea)

Oxygen Cannula



- Designed for easy application and efficient administration of oxygen
- Sliding collar for exact fit
- Twin prongs fit naturally and comfortably into the nasal passages
- Universal funnel connector
- Manufactured from soft, lightweight non toxic clear PVC
- Multichannel tube ensures continuous supply of oxygen even if tube is accidentally kinked
- Non Sterile
- Supplied individually or in a master box of 100
- Adult, child and infant sizes available
- 210cm (7ft) length

GS2016/0 Adult oxygen cannula	£1.00
GS2016/1 Child oxygen cannula	£1.00
GS2016/2 Infant oxygen cannula	£1.00

GS2016/0/100 Adult oxygen cannula, box of 100	£82.00 (£0.82 ea)
GS2016/1/100 Child oxygen cannula, box of 100	£82.00 (£0.82 ea)
GS2016/2/100 Infant oxygen cannula, box of 100	£82.00 (£0.82 ea)

Your local medical supplier is just a phone call away. See cover for full details

Prices shown are exclusive of VAT and delivery

Spirometry & Respiratory Nebulisers

Guardian F4000 Neb-Aid

- Modern high efficiency compact nebuliser
- Unobtrusive and quiet piston compressor
- Attractive black carry and storage case with handle and strap
- Comprehensive accessories package including:
 - Adult soft face mask
 - Child soft face mask
 - Connecting tubing
 - Nebulising chamber
 - Mouthpiece and nasal adaptor
- Air inlet filter

Specifications

Max pressure:	1.5 bar approx.
Compressor output:	9 litres per minute
Dimensions:	18 x 14 x 13cm
Weight:	1.3Kg
Case dimensions:	30 x 17 x 15cm
Case Weight:	2.25Kg
Sound level at 1mt:	56dB(A)
Compliances:	Dir.93/42/EEC EN60 601-1/A2

Spares pack includes:

- Adult or child face mask or mouthpiece
- Nebulising chamber
- Connecting tubing

GS2074/0	Adult Aero Mist Nebuliser kit. Single unit	£3.10
GS2074/1	Child Aero Mist Nebuliser kit. Single unit	£3.10
GS2082/0	Universal Mouthpiece nebuliser kit. Single unit	£3.10



Individual Spares and Accessories

120.00.000	Guardian F4000 Neb-Aid with black leatherette carry case	£58.70
120.00.000/1	Nebulising chamber	£3.10
120.12.000/9	Connecting tubing	£2.59
120.12.000/53	Air inlet filter	£3.10
120.22.000/1	Adult face mask	£2.50
120.12.000/10	Child face mask	£2.50
120.12.000/6	Adult nasal prong	£1.30
120.12.000/7	Child nasal prong	£1.79
120.12.000/5	Mouthpiece	£1.30

HospiNeb – Professional High-Flow Nebuliser

The NEW HospiNeb Nebuliser from Flaem Nuova, with high output airflow, provides fast and efficient nebulisation of all medications, from a compact mains powered device. HospiNeb is suitable for chronic respiratory conditions and severe cases, where a strong powerful unit is required to administer medications in an intensive environment.



HospiNeb is the perfect choice for the GP practice, hospital department and patient with chronic respiratory disease.

Special features of the HospiNeb include:

- **RF6plus nebuliser** – with valve system and twin delivery modes
- **Built in carry handle** – portable and practical
- **Extremely compact** – smallest device in it's class
- **Professional air purification filter**
- **Carry bag** – included as standard, holds unit and accessories
- **Accessories supplied** – RF6plus nebuliser, adult and child masks, mouthpiece with nasal prong, tubing and spare air filters (x2)
- 2 year manufacturers warranty

RF6plus Performance Specification:

Maximum delivery – 0.54ml / min (approx)
MMAD – 2.8µm
Breathable fraction <5µm (FPF) – 76%
Max fill volume – 8ml

Technical Specification:

Air output - 14LPM (approx)
Max pressure - 3.5 bar (approx)
Mains voltage - 240V
Sound level at 1m - 60dB (approx)
Handset weight - 1.5kg
Handset dimensions - 21cm (l) x 16cm (w) x 11cm (h)

120.12.060	HospiNeb Complete	£89.30
-------------------	-------------------	---------------

Your local medical supplier is just a phone call away. See cover for full details

Prices shown are exclusive of VAT and delivery

Nebulair Hi-Flow Nebuliser

- Strong and reliable high output mains nebuliser, very reasonable price
- Maintenance free piston compressor
- 240v mains operated
- Compact unit with built in carry handle
- Nebulises all modern medications efficiently
- Includes 2 sets of accessories, with child and adult masks, chambers, filters, tubing and mouthpieces.
- Can be used lying down
- Specifications:- Output 3.5 bar, 1.4 Lpm high flow output: MMAD 1.49µm: weight 2.4kg: Nebulises 1ml in 1min 30secs approx
- Very quiet operation, approx. 55dBa
- 6 year guarantee



Accessories for Nebulair:

120.12.050/51	Medication chamber complete*	£5.49
120.12.000/9	Drive-line tubing*	£1.30
120.12.000/53	Air inlet filter*	£3.10
120.12.000/52	Adult face mask*	£2.50
120.12.000/10	Child face mask	£2.50
120.12.050/58	Mouthpiece	£1.30
120.12.000/12	Manual air flow control valve	£26.15



120.12.050 Nebulair Hi-Flow Nebuliser, complete **£86.20**

Your local medical supplier is just a phone call away. See cover for full details
Prices shown are exclusive of VAT and delivery

Spirometry & Respiratory Nebulisers

Wi.Neb and Wi.Neb go - Portable Nebuliser

The new Wi.Neb and Wi.Neb go are latest generation, extremely compact portable compressor nebulisers from Flaem Nuova.

The unique modern aesthetics and compact dimensions belie the high performance and convenience of the device.

Wi.Neb can be used from mains 240v or 12v power supply directly and the Wi.Neb go includes a built-in Lithium Ion rechargeable battery, providing approximately 45 minutes running time from a single charge (charge time approx. 2 hours).

The Wi.Neb and Wi.Neb go are supplied with Flaem's RF7 dual-speed nebuliser chamber, drive line tubing, adult and paediatric masks, mouthpiece, nasal prong, carry case and full instructions.

- Reciprocating compressor nebuliser – no maintenance or lubrication required
- Compact dimensions – 130 x 95 x 50mm; handset weight 430gm (Wi.Neb) 570gm (Wi.Neb go)
- Delivery ml/min 0.25min to 0.55 max
- MMAD 4.27µm
- Max pressure 2bar
- Sound level 52dB (A) approx.



Wi.Neb go Nebuliser

120.25.000	Wi.Neb Nebuliser	£182.60
120.27.000	Wi.Neb go Nebuliser	£203.00



120.27.000/1	RF7 Plus Nebuliser Kit. Comprising: Chamber, Mouthpiece and Nasal Prong	£6.00
120.27.000/2	Lithium ion rechargeable battery for the Wineb Go	£79.00
120.27.000/3	Soft touch Paediatric Mask and elastic in sealed bag	£2.85
120.27.000/4	Set of two Filters packed in sealed bag	£1.35
120.27.000/5	Soft touch Adult Mask and elastic in sealed bag	£5.10
120.27.000/6	Switch Mode Power Supply Unit 100-240v 50/60 HZ 12v with plug	£32.00
120.27.000/7	12v Cigarette Lighter Power Cord	£7.00

Lella the Ladybug

- **The Friendliest Nebuliser Ever** – Lella is a compressor nebuliser in the shape of a red ladybug
- **Perfect for Small Children** – the device is not intimidating and makes taking medication more fun and acceptable to children
- **Quiet Operation** – Lella hums away quietly in the background
- **Attractive Transport Case** – the zip carry case is transparent and shaped to fit Lella and all her accessories
- **'Lella the Ladybug' Story Book** – read the story of Lella to your child and help engage their imagination
- **Suitable for Bronchodilators** – and other medications held in suspension
- **Includes Rhino Clear** – for cleansing and medicating the upper airways
- **2 year warranty**



120.30.000	Lella the Ladybug Nebuliser	£90.80
------------	-----------------------------	--------

Accessories for Lella:

120.12.050/1	Medication chamber	£3.10
120.12.000/9	Connecting tubing	£1.30
120.12.000/53	Air inlet filter, pair	£3.10
120.12.000/2	Large face mask	£2.50
120.12.000/10	Child face mask	£2.50
120.12.050/6	Mouthpiece	£1.30



Package Includes:

- Lella the Ladybug Compressor
- Story Book
- Rhino Clear Nasal Washer
- Nebuliser Accessories
 - Chamber
 - Large and small face masks
 - Mouthpiece
 - Tubing
- Mains supply lead
- Instructions
- Carry case

Technical:

- Power supply: mains 220-240 volt
- Maximum air flow: 10 LPM
- MMAD 3.6 µm
- Medication capacity: 2ml (min) – 8ml (max)
- Operating pressure: 0.9bar
- Dimensions: 21 x 16 x 13 cm
- Weight: 1.6kg

Your local medical supplier is just a phone call away. See cover for full details

Prices shown are exclusive of VAT and delivery

Medix AC2000 Nebuliser

- **High Flow Rate Mains Nebuliser** – for fast, efficient nebulisation of medications in the home or professional clinical environment
- **Suitable For All Medications** – commonly prescribed for chronic and acute chest conditions
- **Durable, Compact Case** – with storage space for medications and accessories
- **Easy Controls** – suitable for children and the elderly
- **Includes:**
 - AC2000 compressor unit
 - 2 x Microneb III chambers
 - 2 x drive line tubings
 - Adult mask
 - Paediatric mask
 - Mouthpiece
 - 2 x inlet filters
- **Technical:**
 - Dimensions: 375 x 235 x 115mm
 - Weight: 2.45kg
 - Power supply: 240v mains
 - Flow rate and pressure: 7 LPM @ 20psi / 1.37 bar
 - Particle size: MMAD 3.0 µm
 - Nebulisation time: 2.5 – 5.5 min for 2.5ml
 - % particles: < 5µm 84.1%



120.AC2000	Medix AC2000 Nebuliser	£160.00
120.ACSB	Medix AC shoulder bag	£57.20

Medix World Traveller Nebuliser

- **High Flow Nebuliser** – that automatically works with any mains supply, regardless of the voltage
- **Ready Anywhere** – the most versatile nebuliser for all situations
- **Rechargeable** – built in high-capacity battery can be purchased as an optional accessory
- **12v DC Ready** – use the car lighter lead to power your world Traveller on the move
- **High Flow Output** – suitable for nebulisation of bronchodilators, corticosteroids and antibiotics
- **Durable Case** – holds medications and accessories for safe transportation
- **Includes:**
 - World Traveller compressor unit
 - 2 x Microneb III chambers
 - 2 x drive line tubings
 - Adult mask
 - Paediatric mask
 - Mouthpiece
 - 2 x inlet filters



- **Technical:**
 - Dimensions: 375 x 235 x 115mm
 - Weight: 2.8kg w/o battery
 - Power supply: 110 - 240v mains 50-60 Hz AC or 12v DC
 - Flow rate and pressure: 7 – 8.5 LPM @ 20psi
 - Particle size: MMAD 3.0 µm
 - Nebulisation time: 2.5 – 5.5 min for 2.5ml
 - % particles: < 5µm 80%

120.WTSB	Medix World Traveller shoulder bag	£61.65
120.WTBP	Rechargeable battery pack	£87.50

120.2000WT	Medix Vario Traveller Nebuliser	£365.00
-------------------	---------------------------------	----------------

Your local medical supplier is just a phone call away. See cover for full details

Prices shown are exclusive of VAT and delivery

Spirometry & Respiratory Nebulisers

AirPro3000 Nebuliser

Professional aerosol therapy unit for hospital use and home care.



AirPro 3000 Standard Nebuliser

- Durable powerful compressor ensures continuous use, speed of operation and low noise level
- Can easily be transported by means of the ergonomic integrated handle
- Features convenient nebuliser holder suitable for the most commonly used jet nebulisers and can easily be fitted to the right or left side of the device
- High efficiency professional filter can be checked for cleaning or replacement through the transparent cover
- Unit comes with the RF7 Dual Speed Plus nebuliser with valve system

AirPro 3000 Plus Nebuliser

- Durable powerful compressor ensures continuous use, speed of operation and low noise level
- Equipped with an adjustable pressure knob to set pressure/flow rate and a gauge to control it for a more accurate therapy treatment (MMAD and FPF) and better compliance
- Can easily be transported by means of the ergonomic integrated handle
- Features convenient nebuliser holder suitable for the most commonly used jet nebulisers and can easily fit to the right or left side of the device
- High efficiency professional filter can be checked for cleaning or replacement through the transparent cover
- Unit comes with the RF7 Dual Speed Plus nebuliser with valve system

AirPro3000 Standard	MIN	MAX
Delivery ml/ minute	0.29	0.65
MMAD μm	2.21	2.38
Respirable fraction < 5 μm	84.20%	85.10%
Fill Valve		8ml

AirPro3000 Plus	Level 1		Level 2		Level 3	
Operating Pressure (bar)	0.8		1.05		1.45	
Flow at jet nebuliser ltr/min	6.8		7.1		8.2	
Speed Selector	Valve	MAX	Valve	MAX	Valve	MAX
MMAD μm	2.95	2.44	2.53	2.72	2.21	2.38
Delivery ml/minute	0.18	0.42	0.23	0.53	0.29	0.65

AP25P00 AirPro 3000 Standard Nebuliser **£149.00**

AP50P00 AirPro 3000 Plus Nebuliser **£169.00**

Your local medical supplier is just a phone call away. See cover for full details

Prices shown are exclusive of VAT and delivery

Aero Mist Nebuliser Kit

- Controlled medication kits
- Soft clear aerosol mask with anatomical form ideal for long term use
- Gently rolled, feathered edges with integrated nasal bridge for extra comfort
- Swivel connector for convenience of nebulisation in horizontal and vertical position ensuring patient comfort
- Larger surface area provided by unique convex cone design ensures maximum capillary action and helps eliminate medicinal wastage
- Nebulises 3cc in 10 minutes
- Graduated fill markers
- Suitable for use with a wide range of compressors
- Complete set includes face mask (adult or child), nebulising chamber, 210cm (7ft) tubing with universal cone connectors.
- Optionally available with mouth piece and T connector for oral medication
- Available individually or in master box of 50 units

Aero Mist Nebuliser kit



Universal Mouthpiece Nebuliser kit



GS2074/0	Adult Aero Mist Nebuliser kit. Single Unit	£3.10
GS2074/1	Child Aero Mist Nebuliser kit. Single Unit	£3.10
GS2082/0	Universal Mouthpiece Nebuliser kit. Single Unit	£3.10

GS2074/0/50	Adult Aero Mist Nebuliser kit. Master box of 50	£112.00 (£2.24 ea)
GS2074/1/50	Child Aero Mist Nebuliser kit. Master box of 50	£112.00 (£2.24 ea)
GS2082/0/50	Universal Mouthpiece Nebuliser kit. Master box of 50	£112.00 (£2.24 ea)

Your local medical supplier is just a phone call away. See cover for full details

Prices shown are exclusive of VAT and delivery

Audiometry Audiometers

Amplivox 116 Screening Audiometer - 2011 model

- All purpose audiometer for primary care, school and industrial use
- Unique time-saving threshold retention feature.
- Cost effective price
- Totally portable (weighs 650g)
- Hearing level print-outs with optional printer
- Pure, pulsed, continuous and warble tones
- -10 to 100 dBHL intensity range
- Silent operation tone present function
- Supplied with mains adapter, carrying case and patient response switch



AU116 Amplivox 116 Audiometer (2011 model) **£807.00**

Optional accessories for Amplivox 116:

AU116.4	Designated thermal printer	£248.70
AU116.3	Battery power function	£107.10
AU601	Audiocups	£112.90

Amplivox Calibration Services:

All audiometers should be calibrated at regular intervals.
To arrange the calibration of an Amplivox audiometer or tympanometer please call Amplivox on 01865 842411

All Amplivox audiometers are CE marked and conform to the relevant sections of the International audiometric standard EN60645.

Maico MA25 Audiometer



Ideal for clinics and school nurses

Portable robust lightweight audiometer suitable for measuring air conduction thresholds in schools, industry and wherever quick hearing evaluations are performed.

- Robust construction
- 11 frequencies 125Hz to 8kHz
- Customise frequency test selections
- Output levels from -10dB to 100dBHL output
- Pure tone, warble tone and pulsed tone
- Battery status indicator
- Carrying bag
- Uses standard AA batteries
- Supplied with headset

Options:

- Patient response switch
- Noise reducing headset
- Ext. power supply

Also available as AS608E, including Hughson-Westlake test and patient communication.

MA/MA25/2.BOM Maico MA25 Audiometer **£880.00**
MA/MA25E/1.BOM **£1495.00**
Maico MA25 with Hughson-Westlake test

AWK-215 Patient response switch **£36.80**
TS608 Mains adaptor **£98.00**

Your local medical supplier is just a phone call away. See cover for full details

Prices shown are exclusive of VAT and delivery

Audiocups and Headsets

- Noise reducing enclosures to fit over headsets and reduce ambient noise when testing

Image shows enclosures fitted over headset



AU601 Audiocups - noise reducing enclosures **£112.90**

THD39 Replacement headsets **£249.00**

Please note that replacement headsets must be calibrated to each machine and it is therefore necessary for your audiometer to be returned for calibration and fitting of headset.

AW Spirit Tuning Forks

- Lightweight aluminium alloy tuning forks
- Precision frequency balanced
- Very reasonably priced
- Choice of 128Hz or 256Hz



G.650.00 AW Spirit 128hz Tuning Fork **£22.50**

G.650.01 AW Spirit 256hz Tuning Fork **£22.50**



- Chrome plated steel

Tuning Forks

G.600.00 Gardiner Brown Tuning Fork with foot, 128Hz **£27.90**

G.600.01 Gardiner Brown Tuning Fork with foot, 256Hz **£27.90**

G.600.02 Gardiner Brown Tuning Fork with foot, 512Hz **£27.90**

G.600.03 Gardiner Brown Tuning Fork with foot, 1024Hz **£27.90**

G.600.04 Gardiner Brown Tuning Fork with foot, 2048Hz **£27.90**

G.600.05 Gardiner Brown Tuning Fork with foot, 4096Hz **£27.90**

G.600.10 Gardiner Brown Tuning Fork, set of 6 in box **£223.80**



AB-125 **£88.80**

Martin Rydel Seiffer Tuning Fork with adjustable frequency

Your local medical supplier is just a phone call away. See cover for full details

Prices shown are exclusive of VAT and delivery

Disposables & Practice Sundries **Gloves**

Our glove prices are continually reviewed to reflect market conditions. Call for today's best price



Vinyl Examination Gloves

A range of high quality vinyl gloves, ambidextrous with beaded cuffs, available pre-powdered or powder-free.

AWD120	Powder-free small, box 100	P.O.A
AWD125	Powder-free small, case 10 x 100	P.O.A
AWD121	Powder-free medium, box 100	P.O.A
AWD126	Powder-free medium, case 10 x 100	P.O.A
AWD122	Powder-free large, box 100	P.O.A
AWD127	Powder-free large, case 10 x 100	P.O.A
AWD130	Pre-powdered small, box 100	P.O.A
AWD135	Pre-powdered small, case 10 x 100	P.O.A
AWD131	Pre-powdered medium, box 100	P.O.A
AWD136	Pre-powdered medium, case 10 x 100	P.O.A
AWD132	Pre-powdered large, box 100	P.O.A
AWD137	Pre-powdered large, case 10 x 100	P.O.A

Guardian Latex Examination Gloves

A range of high quality latex, tear resistant, gloves. Available pre-powdered or powder-free and non-sterile. Supplied in dispenser box of 100. Complete with hand-size gauge.

AWD201	Powder-free small, box 100	P.O.A
AWD205	Powder-free small, case 10 x 100	P.O.A
AWD202	Powder-free medium, box 100	P.O.A
AWD206	Powder-free medium, case 10 x 100	P.O.A
AWD203	Powder-free large, box 100	P.O.A
AWD207	Powder-free large, case 10 x 100	P.O.A
AWD101	Pre-powdered small, box 100	P.O.A
AWD111	Pre-powdered small, case 10 x 100	P.O.A
AWD102	Pre-powdered medium, box 100	P.O.A
AWD112	Pre-powdered medium, case 10 x 100	P.O.A
AWD103	Pre-powdered large, box 100	P.O.A
AWD113	Pre-powdered large, case 10 x 100	P.O.A

Your local medical supplier is just a phone call away. See cover for full details
Prices shown are exclusive of VAT and delivery

Nitrile Examination Gloves

Premium quality, chemical and tear resistant nitrile gloves. Powder and latex free containing no allergic properties, ideal for sensitive skin. Supplied in dispenser box of 100.



AWD601	Powder-free small, box 100	P.O.A
AWD601/10	Powder-free small, case 10 x 100	P.O.A
AWD602	Powder-free medium, box 100	P.O.A
AWD602/10	Powder-free medium, case 10 x 100	P.O.A
AWD603	Powder-free large, box 100	P.O.A
AWD603/10	Powder-free large, case 10 x 100	P.O.A
AWD604	Powder-free extra large, box 100	P.O.A
AWD604/10	Powder-free extra large, case 10 x 100	P.O.A

Dracula - Universal Holder for tissue and Glove Boxes

- Dracula, the universal wall holder for all tissue and glove boxes
- Dracula's vertical spring-loaded clamp has little teeth that hold the box firmly in place
- Gloves and tissues can be dispensed single-handed
- Fits all sizes of gloves and tissues



AWD750 £6.10
Dracula tissue and glove box holder

Glove Box Holders



DG/1 £14.10
Wire single glove box holder, with wall mounting

DG/3 £17.90
Wire treble glove box holder, with wall mounting

Disposables & Practice Sundries Paper Products & Dispensers

Toilet Tissue: Toilet Rolls



AWD-162403 **£19.20**

Whisper soft conventional toilet rolls,
110mm x 110mm x 240 sheets, case 40 rolls (10 packs of 4)

AWD-T22006 **£12.00**

Essentials conventional toilet rolls,
112mm x 95mm x 200 sheets, case 36 rolls (18 packs of 2)

AWD-BP8150 **£19.30**

Bulk Pack Toilet Paper, flat fold,
200mm x 105mm x 250 sheets, case 36

AWD-DS926E **£13.80**

Bulk pack toilet paper dispenser, plastic, 275h x 150w x 130d

AWD-J26410 **£21.20**

Jumbo toilet rolls 2ply white, 92mm x 410m, case of 6

AWD-DS925E **£19.40**

Connect jumbo toilet roll dispenser, plastic, 375h x 340w x 145d

AWD-J26300 **£15.90**

Mini-jumbo toilet rolls 2ply white, 92mm x 300m, case of 6

AWD-DS924E **£16.80**

Connect mini-jumbo toilet roll dispenser, plastic, 235h x 280w x 145d



C-Fold System



AWD-HT1101 **£17.90**

C-fold hand towels green, 310 x 225mm x 172 sheets, 1 ply,
case of 15

AWD-HT2904 **£17.90**

C-fold hand towels blue, 310 x 225mm x 172 sheets, 1 ply,
case of 15

AWD-HT3000 **£23.00**

C-fold hand towels white deluxe 2 ply, 310 x 225mm x 157 sheets,
case of 15

AWD-DS923E **£18.90**

Connect C-fold hand towel dispenser, plastic, 425h x 290w x 145d

Hand Towel Rolls

10" / 25cm towel rolls, 2 ply with perforations.
50m per roll.

AWD-DS0911 **£37.40**

Wall Mountable 10" / 25cm hygiene roll
dispenser, lockable with serration

AWD320/1C **£25.50**

Towel Roll 10" white, case of 18

AWD320/2C **£46.50**

Towel Roll 10" white, 2 cases of 18

AWD320/4C **£87.80**

Towel Roll 10" white, 4 cases of 18

AWD330/1C **£25.50**

Towel Roll 10" blue, case of 18

AWD330/2C **£46.50**

Towel Roll 10" blue, 2 cases of 18

AWD330/4C **£87.80**

Towel Roll 10" blue, 4 cases



Your local medical supplier is just a phone call away. See cover for full details

Prices shown are exclusive of VAT and delivery

Couch Rolls

20" / 50cm couch rolls, 2 ply with perforations.
50m per roll.



AWD-DS0921



AWD-DS0921 Wall mountable 20" / 50cm couch roll dispenser, lockable with serration	£48.50
AWD302/1C Couch Roll 20" white, case of 9	£18.50
AWD302/2C Couch Roll 20" white, 2 cases of 9	£34.95
AWD302/4C Couch Roll 20" white, 4 cases of 9	£67.95

AWD312/1C Couch Roll 20" blue, case of 9	£18.50
AWD312/2C Couch Roll 20" blue, 2 cases of 9	£34.95
AWD312/4C Couch Roll 20" blue, 4 cases of 9	£67.95

Hand Towels



AWD-C2W065 Mini centre-feed hand towel rolls 197mm x 65m, 2 ply white, pack of 12	£17.80
AWD-DS9220 Mini centre-feed hand towel dispenser, plastic, 330h x 180w x 175d	£16.30
AWD-C2W150 Centre-feed hand towel rolls 197mm x 150m 2 ply white, pack of 6	£17.60
AWD-DS922E Connect Centre-feed hand towel dispenser, plastic, 350h x 230w x 235d.	£18.80

Your local medical supplier is just a phone call away. See cover for full details
Prices shown are exclusive of VAT and delivery

Disposables & Practice Sundries **Sutures**

B. Braun Medical Ltd

- Manufacturers of sutures for over 100 years
- Save up to 30% compared to alternative brands
- On NHS contract
- Prices are for boxes of 36
- 5 year shelf life
- High tensile strength
- Excellent knotting ability
- Smooth passage through tissue
- Easy handling
- See varieties available on Drug Tariff



Claimable Sutures (available on Drug Tariff)

Ethicon DT Code	B. Braun DT Code	Material	Needle	Length	Colour	Gauge	Description	Qty	Price
W9074	C0068150	SAFIL	18mm	70cm	violet	4/0	3/8 circle round bodied needle	36	£122.75
W1615T	C0936146	DAFILON	16mm	45cm	blue	6/0	3/8 circle reverse cutting needle with micro point	36	£65.20
W1618T	C0936227	DAFILON	19mm	45cm	blue	5/0	3/8 circle reverse cutting needle with micro point	36	£65.20
W319	C0933201	DAFILON	19mm	45cm	blue	4/0	3/8 circle reverse cutting needle	36	£38.40
W320	C0932353	DAFILON	24mm	45cm	blue	3/0	3/8 circle reverse cutting needle	36	£37.40
W3650	C0023285	MONOSYN	60mm	70cm	undyed	3/0	straight cutting needle	36	£106.00
W8020T	C2090655	PREMILENE	24mm	45cm	blue	4/0	3/8 circle reverse cutting needle with micro point	36	£99.10
W9918	C1046213	SAFIL QUICK	16mm	70cm	undyed	4/0	3/8 circle reverse cutting needle	36	£107.25
W9922	C1046420	SAFIL QUICK	19mm	70cm	undyed	4/0	3/8 circle reverse cutting needle	36	£99.25
W9923	C1046530	SAFIL QUICK	19mm	70cm	undyed	3/0	3/8 circle cutting needle with micro point	36	£123.65
W9932	C1046657	SAFIL QUICK	24mm	70cm	undyed	3/0	3/8 circle reverse cutting needle with micro point	36	£145.85
W9962	C1046651	SAFIL QUICK	37mm	90cm	undyed	2/0	1/2 circle round bodied needle with trocar point	36	£131.75

Non Claimable Sutures

Ethicon Code	B. Braun Code	Material	Needle	Length	Colour	Gauge	Description	Qty	Price
W9443	C1048513	SAFIL	16mm	70cm	violet	4/0	3/8 circle cutting needle	36	£92.00
W9525T	C0069656	SAFIL	24mm	45cm	undyed	3/0	3/8 circle cutting needle	36	£139.50
W9114	C0068030	SAFIL	22mm	70cm	violet	3/0	1/2 circle round bodied needle	36	£115.50
W1616T	C0936154	DAFILON	16mm	45cm	blue	5/0	3/8 circle cutting needle	36	£62.30
W1620T	C0936235	DAFILON	19mm	45cm	blue	3/0	3/8 circle cutting needle	36	£61.40
W506	C0932116	DAFILON	16mm	45cm	blue	6/0	3/8 circle reverse cutting needle	36	£68.00
W568	C0930601	DAFILON	30mm	100cm	blue	2/0	1/2 circle round bodied	36	£33.00
W321H	C0762369	SILKAM	24mm	75cm	black	2/0	3/8 circle reverse cutting needle	36	£53.00
W2511T	C0766275	SILKAM	24mm	45cm	black	3/0	3/8 circle needle with micro point	36	£71.00
W328H	C0760412	SILKAM	26mm	75cm	black	3/0	1/2 circle round bodied needle	36	£49.25
W501H	C0764132	SILKAM	16mm	75cm	black	4/0	3/8 circle cutting needle	36	£46.20
W3548	C0022094	MONOSYN	18mm	70cm	violet	4/0	3/8 circle round bodied	36	£105.00
W8025T	C2090656	PREMILENE	26mm	45cm	blue	3/0	3/8 circle cutting needle	36	£99.20
W9941	C1046236	SAFIL QUICK	24mm	70cm	undyed	2/0	3/8 circle cutting needle	36	£102.25

Your local medical supplier is just a phone call away. See cover for full details

Prices shown are exclusive of VAT and delivery

Spill Pak – Biohazard Kit

Single use pack for the safe disposal of body fluid spillages.



Contents:

- 100ml Haz-Tab granules
- 4 x Mini Haz tablets
- synthetic gloves
- apron
- paper towels
- scoop / scraper
- disposal bag
- instructions

AWD-GM8617/1	Spill Pak BH, each	£5.95
AWD-GM8617	Spill Pak BH x 10	£45.20

Spill Pak – Urine/Vomit Kit

Single use pack for the safe disposal of urine and vomit spillages.



Contents:

- 500ml absorbent granules
- alcohol surface wipes
- synthetic gloves
- apron
- paper towels
- scoop / scraper
- disposal bag
- instructions

AWD-GM8721/1	Spill Pak UV, each	£4.50
AWD-GM8721	Spill Pak UV x 10	£39.90

Spills Kit – Urine and Vomit Kit

Complete kit for the safe collection of urine and vomit spills. 15 applications per kit.

Contents:

- 6 tubs of NQ64 quaternary granules
- 15 scoops/scrapers
- 1 tube surface wipes
- 30 synthetic gloves
- 15 disposal bags
- 15 aprons
- instructions



AWD-G8625	Spills kit UV, 15 uses	£54.45
------------------	------------------------	---------------

Mercury Spills Kit

2 mercury spills collection units.

Contents:

- syringe
- absorbent powder
- disposal jar
- nitrile gloves
- apron
- instructions



AWD-G9512	Mercury spills kit	£57.20
------------------	--------------------	---------------

Cytotoxic Drug Spills Kit

For the safe removal of cytotoxic drug spills. The CT-Zorb granules quickly soak up the spillage, preventing further spread. Other items in the kit allow the fast, safe removal and disposal of the spill. Suitable for 15 uses.

Contents:

- 2 tubs CT-Zorb granules
- 15 scoops/scrapers
- 1 tub surface wipes
- 50 nitrile gloves
- 15 protective aprons
- 15 disposal bags
- 15 face masks
- instructions



AWD-G9612	Cytotoxic drug spills kit, 15 uses	£70.60
------------------	------------------------------------	---------------

Your local medical supplier is just a phone call away. See cover for full details
Prices shown are exclusive of VAT and delivery

Disposables & Practice Sundries Hand & Surface Cleaners

B Braun Meliseptol Foam Pure



- Surface disinfectant foam spray
- 750ml trigger spray bottle
- Only 20% alcohol
- Effective for 20 minutes

AWD-BMS750 Meliseptol Foam Pure 750ml **£6.90**

Sanicloth 70 Alcohol Wipes

- Bacterial surface wipes
- Dispenser pack 200



AWDSC00159 Sanicloths **£5.75**

NewGenn Anti-Microbial Disinfectant Solutions, Sprays, Rubs and Wipes

All NewGenn antimicrobial products are water based and derived from natural plant oils and are animal product and alcohol free.

Protect yourself, your environment and those you care for from bacteria and the many surface born viruses, prevalent on the skin, in the surgery or the care home.



Hand washes and rubs

Foam hand washes, standard or deep wash and foam hand rub in 500ml bottles or 50ml handy dispenser. 5 Litre refill containers are available on request.

AWD-NG12	£6.00
Foam hand wash, 500ml	
AWD-NG11	£6.00
Foam deep hand wash, 500ml	
AWD-NG10	£6.00
Foam hand rub, 500ml	
AWD-MF01	£2.60
Foam hand rub, 50ml	
AWD-MFC01	£5.10
Foam hand rub with belt clip, 50ml	

High level disinfectants

Concentrated disinfectant. Dilute to 1% in clean water. Available non-fragranced or fragranced with eucalyptus.

AWD-NG06	£25.50
Disinfectant 1 litre, non-fragranced	
AWD-NG05	£51.00
Disinfectant 5 litre, non-fragranced	
AWD-NGF05	£51.00
Disinfectant 5 litre, eucalyptus	
AWD-NGF06	£51.00
Disinfectant 5 litre, citrus	
AWD-NGF08	£51.00
Disinfectant 5 litre, raspberry	

Personal care

Skin foam protects against bacteria over the body and all-purpose wet wipes can be used for the body and surfaces.

AWD-PC500	£4.70
Personal care foam 500ml	
AWD-NG14	£2.60
All-purpose wet wipes, pack 15	
AWD-NG04	£3.50
All-purpose wet wipes, pack 52	

Hard and soft surface spray

Surface spray in 500ml trigger spray dispenser bottle.

AWD-NG01	£3.60
Surface spray 500ml	

Your local medical supplier is just a phone call away. See cover for full details

Prices shown are exclusive of VAT and delivery

Hand & Surface Cleaners Disposables & Practice Sundries



Alcohol Hand Rubs

Alcohol based hand-rub sanitisers, available in large dispenser bottles and 50ml clip-on 'tottle' spray bottles.



H8750	£5.00
GM alcohol rub 500ml	
AWD-GMAR02	£1.80
GM alcohol rub 50ml tottle, each	
AWD-GMAR02/10	£16.40
GM alcohol rub 50ml tottle x 10	
AWD-GJ9665	£5.70
Purell hand sanitiser 350ml	

Cutan Soap and Sanitiser



Receive a free wall dispenser worth £6.99 with every 6 Cutan hand soap or hand gel purchased

AWD-CHS01	£6.90
Cutan soap, 1 litre 'bag'	
AWD-CHS02	£7.20
Plastic wall dispenser for Cutan soap <i>FREE with 6 litres of Cutan soap</i>	
AWD-CHS03	£9.40
Cutan hand sanitiser, 1 litre 'bag'	
AWD-CHS04	£7.20
Plastic wall dispenser for Cutan sanitiser <i>FREE with 6 litres of Cutan sanitiser</i>	

B Braun – Complete Hand Care

Sponsors of the NHS clean your hands campaign, B Braun hand washes, rubs and creams offer a complete hand care solution. Supplied ready to use in handy 500ml dispenser bottles.



Softalind ViscoRub – alcohol based hand-cleansing rub

AWD-BBSL	£6.00
Softalind hand sanitiser 500ml, each	
AWD-BBSL/5	£27.60
Softalind hand sanitiser 500ml x 5	



Lifosan Pure – hand wash lotion

AWD-BBLP	£5.10
Lifosan wash lotion 500ml, price each	
AWD-BBLP/5	£19.40
Lifosan wash lotion 500ml x 5	
AWD-BBWD	£6.20
Wall mounted holder for 500ml bottles	

Trixo-lind Skin Cream – daily care for sensitive skin

AWD-BBTL	£8.70
Trixo skin cream 500ml, each	
AWD-BBTL/5	£41.90
Trixo skin cream 500ml x 5	
AWD-BBTLT	£4.50
Trixo skin cream 100ml tube, each	
AWD-BBTLT/5	£21.00
Trixo skin cream 100ml tube x 5	



TORK Soap Dispenser S-Box and Mevon Soaps

- Tough wall dispenser with easy action dispensing lever
- Durable construction
- Lockable with viewing window
- Can be used with TORK mild soap and anti-bacterial soaps
- All dispensers are drip and clog proof and have no corroding parts
- They are all fitted with quality key locks. Strong plastic body

061651	£38.45
TORK Soap Dispenser. S-Box	
061.046	£58.65
Mevon 88 Bactericidal Alcohol Free Soap. Pack of 6, 1 litre bottles	

Your local medical supplier is just a phone call away. See cover for full details

Prices shown are exclusive of VAT and delivery

Disposables & Practice Sundries Hand & Surface Cleaners

Hand Hygiene

Spirigel Complete - Alcohol Hand Disinfectant

Spirigel complete provides an extra level of protection in hospitals, GP surgeries, Veterinary surgeries and Dental practices.

- Contains seven skin care ingredients including Aloe vera, panathenol and glycerine
- Approved for both hygienic and surgical use
- Wide range of dispensing options specifically designed for all points of use
- Low viscosity formulation

3056230	800ml pouch	£5.00
3055090	500ml pump	£3.90
3056190	60ml pump	£1.95



Spirigel Alcohol Hand Gel

Spirigel is a clear, colourless and perfume-free alcohol hand gel which can be used to rapidly and effectively decontaminate hands without water.

- Contains glycerin emollients to moisturize the skin and helps to raise compliance levels
- Dermatologically tested

3034370	800ml pouch	£5.50
3030540	500ml pump	£5.50
3030550	500ml	£4.50
3030560	150ml flip top	£1.35
3030590	60ml pump	£1.40

Seraman Sensitive Hand Wash

Sensitive, gentle hand wash formulation

- PH5.5 maximises skin cleansing efficacy whilst maintaining excellent skin compatibility
- Fragrance and dye free
- Dermatologically tested

3029130	1 ltr	£5.50
3050330	1 ltr foam	£6.50
3029150	800ml	£4.50
3029070	500ml	£2.85
3029450	150ml	£2.00



Your local medical supplier is just a phone call away. See cover for full details

Prices shown are exclusive of VAT and delivery

Hand Hygiene Community Pack

- Contains alcohol hand gel (Spirigel -150ml, hand wash (Seraman sensitive -150ml) and moisturiser (Silonda Sensitive - 60ml)
- Reusable zip bag



3037620 £10.50
Hand Hygiene Community Pack

Hand Hygiene Dispensers

- Ecolab (Brightwell) fully lockable, tamperproof dispenser suitable for use with 800ml pouches
- Bracket dispenser for 500ml pumps



700090 £22.50
Ecolab (Brightwell) dispenser

401512 £8.50
Bracket dispenser

Silonda Sensitive Skin Care Lotion

Sensitive, non greasy water based lotion

- Designed to regenerate skin's natural barrier and aid hydration
- Light formulation for easy absorption
- Fragrance and dye free
- Dermatologically tested



3029090 £4.75
Silonda Sensitive 500ml

3029790 £2.50
Silonda Sensitive 60ml

Surface Hygiene

Actichlor Chlorine Releasing Tablets

Actichlor

- High level of disinfectant after cleaning
- Easy dilution calculations for all users Actichlor Plus
- Clean and disinfect in one easy step
- Easy dilution calculations for all users



3049670 Actichlor 2.5g x 100 £10.50

3030520 Actichlor Spill Kit £48.50

3037680 Actichlor granules 500g £8.00

3029060 Actichlor Plus 1.7g x 150 £11.50

Sani-Cloth Detergent Wipes

- Alcohol-free wipes for the disinfection of non-invasive devices and non porous surfaces
- 225 wipes per bucket dispenser



XP00192 £5.50
Sani-Cloth 225 Disinfectant Wipe bucket

Cliniwipe Alcohol Wipes



- Non-woven king size wipes impregnated with IPA 70% v/v
- 200 wipe canister

3036700 £5.50
Cliniwipe Alcohol Wipes

Your local medical supplier is just a phone call away. See cover for full details

Prices shown are exclusive of VAT and delivery

Disposables & Practice Sundries Syringes & Needles

BD Microlance Needles

AWD-BD304622	£9.70
18g / 1 1/2", box 100	
AWD-BD300300	£3.00
26g / 1", box 100	
AWD-BD300400	£3.00
25g / 1", box 100	
AWD-BD300700	£3.00
23g / 1 1/2", box 100	
AWD-BD300800	£3.00
23g / 1", box 100	
AWD-BD301000	£6.60
22g / 1 1/2", box 100	



BD Plastipak Syringes



AWD-BD300013	1ml syringe, box 50	£8.30
AWD-BD300185	2ml syringe, box 50	£7.00
AWD-BD302187	5ml syringe, box 50	£6.40
AWD-BD302188	10ml syringe, box 50	£8.90
AWD-BD300613	20ml syringe, box 50	£17.00

BD Vacutainer Blood Collection System

Blood collection needles:

AWD-VS360215	20g / 1 1/2", box 100	£10.70
AWD-VS360212	21g / 1", box 100	£10.70
AWD-VS360211	22g / 1 1/2", box 100	£10.70
AWD-VS360210	22g / 1", box 100	£10.70

Blood collection tubes:

AWD-VS366645	Tube ACD (A) 8.5ml, box 100	£25.20
AWD-VS367838	Tube EDTA (K2) 3ml, box 100	£12.30
AWD-VS367873	Tube EDTA (K2) 6ml, box 100	£12.30

Blood collection systems, Vacutainer safety lock:

AWD-VS367282	21g / 7" tube, box 50	£38.70
AWD-VS367284	23g / 7" tube, box 50	£38.70

BD Blunt Fill Needles

Not for skin injection



AWD-BD305180	18g x 1 1/2", box 100	£9.70
---------------------	-----------------------	--------------

Mediflex Infusion/Giving Set

- Infusion set for the administration of sterile solutions
- Filter size 15 micron
- Tubing internal diameter 3mm, length 1650mm
- Sold individually or in , box of 100



UN998606/1	Infusion set, each	£1.00
UN998606	Infusion set, box 100	£76.50

IV Cannula



AWD -1132214	Orange 14g, box 50	£64.30
AWD -1132216	Grey 16g, box 50	£64.30
AWD -1132218	Green 18g, box 50	£64.30
AWD -1132220	Pink 20g, box 50	£64.30
AWD -1132222	Blue 22g, box 50	£64.30

Your local medical supplier is just a phone call away. See cover for full details

Prices shown are exclusive of VAT and delivery

Provita Hygiene Centre

This unique and novel hygiene centre has been designed to help reduce the risk of hospital based cross infection between departments, patients, visitors and health care workers.

Manufactured from stainless steel the hygiene centre is portable and easy to clean with any long lived surface disinfectant. Major components can be colour coded for use in specific areas.

Components fitted are:

- 2 Glove box holder
- 500cc disinfectant dispenser (suitable for all proprietary disinfectants)
- Drip bowl, 2 litre
- Wire mesh utensils basket
- Wire mesh basket
- Mobile stand

Available in blue, yellow or silver finish



S02512PB	Hygiene centre, blue finish	£1239.00
S075012OL	Hygiene centre, yellow finish	£1239.00
S02512OS	Hygiene centre, silver finish	£1239.00



Rigi-Box Steri

- Safety box for the sterilisation and disposal of medical waste
- Large capacity Rigi-Box for steam sterilisation of class C infectious waste pre-disposal, or normal disposal of class A and B waste
- Locking lid with stable handle and 2 handle recesses in base of unit
- Steri box can be stacked if empty OR full
- Auto-vent device for safe autoclaving at 134 degrees
- Available in 35 litre and 60 litre capacities

AWDR35 **£10.80**
35 litre container, H330mm x W390mm x L390mm, weight 1.228g

AWDR60 **£13.10**
60 litre container, H520mm x W390mm x L390mm, weight 1.871g

Sharps containers

- Orange lids

AWD510	Mini Sharps Bin 0.6 Litre	£2.20
AWD520	Community Plus Sharps Bin 1 Litre	£1.90
AWD522S	Sharps Bin 2.5 Litre	£1.60
AWD525	Sharps Bin 3.75 Litre	£1.90
AWD530	Sharps Bin 5 Litre	£2.50
AWD532	Sharps Bin 7 Litre	£3.20
AWD535	Sharps Bin 11.5 Litre	£4.10
AWD540	Sharps Bin 22 Litre	£8.30

Alternative Colour-coded Sharps Bins are available on request.



Your local medical supplier is just a phone call away. See cover for full details

Prices shown are exclusive of VAT and delivery

Blood & Urine Analysis

Siemens Clinitek® STATUS+

The Clinitek Status+ analyzer from Siemens is the latest generation automated analyzer with touch-screen controls. It is designed to deliver accurate and reliable results using Siemens (Bayer) urinalysis strips or hCG tests, providing a printed report with interpretation of results.

The Status+ Analyser has advanced features that check the quality of each test undertaken and also the condition of each test strip used, checking for exposure to excessive humidity.

The Clinitek Status+ can be used with Multistix test strips, Microalbumin test strips and Clinitest hCG pregnancy tests.

The type of test strip being used is automatically recognised by the Status+ and the reporting process is simple and straightforward for the user.

- Touch screen interface – controls are simple and intuitive
- Internal memory – stores up to 200 tests
- Mains or battery operated (requires 6 x AA batteries, not included)
- Fast built-in printer – print results record
- Dimensions – 272 x 171 x 158mm
- Weight – 1.66kg



Accessories for Clinitek STATUS+

Clinitest hCG Pregnancy Test

- Qualitative hCG test for pregnancy
- Can be used with Clinitek Status+ Analyser
- Supplied in box of 25 cartridges



1037976 CLINITEK Status+ Analyser **£811.50**

Accessories for Clinitek STATUS+:

6484105	Clinitest hCG, box 25	£92.90
7043714	Clinitek Chek-Stix control sticks, box 25	£58.10
2924704	Clinitek Microalbumin, box 25	£61.80
6916863	Clinitek Microalbumin 9, box 25	£94.40
6352780	Clinitek paper rolls, pack of 5	£39.90

Your local medical supplier is just a phone call away. See cover for full details

Prices shown are exclusive of VAT and delivery

Siemens DCA Vantage™

The new DCA Vantage Analyser is the point-of-care diabetes system that gives you the most proven, clinically relevant menu available today, delivering enhanced HbA1C and Microalbumin testing results including A:C Ratio.

- HbA1C and A:C Ratio testing in just six and seven minutes, respectively
- Increases patient comfort by requiring a small blood sample (1uL) for HbA1C
- Provides HbA1C patient trend graph

Improved clinical confidence:

- Proven to provide accurate and precise lab-quality results
- Optional barcode patient data entry to reduce transcription errors

Enhanced productivity:

- Onboard printed results; eliminates transcription errors and saves time
- Large memory stores up to 4000 records, easily downloaded and transferred to a PC

Proven simplicity:

- Add sample to test cartridge, load, and walk away



- No sample or reagent preparation
- Colour touch screen display for easy menu navigation, data entry and recall
- Minimal maintenance required with automatic reminders

See Diabetes Care from a Whole New Perspective

6651932

DCA Vantage Analyser

£5295.00

Accessories for DCA Vantage Analyser:

3714363

DCA HBA1C Control Kit

£101.00

6162000

DCA HBA1C Reagent Kit

£152.00

6916803

DCA Microalbumin Control Kit

£99.90

1443699

DCA Microalbumin Reagent Kit

£150.50

6502880

DCA Barcode Reader Kit

£451.70

Blood Lancets

- Stainless steel
- Sterile
- Economically priced



1110101

Box of 200 single use, sterile, blood lancets

£6.00

Allergy Lancets

- Specially designed small tip for allergy testing
- 0.9mm tip length
- Stainless steel, single packed, sterile
- Economic box of 200



1110106

Allergy lancets with 0.9mm tip

£11.80

Lancing Device

- For painless blood sampling
- Easy regulation of penetration depth
- Use with 1110104 Blood Lancets



1110110

Lancing device - use with 1110104 lancets

£9.40

1110104

Sterile blood lancets, pack of 100

£4.60

Your local medical supplier is just a phone call away. See cover for full details

Prices shown are exclusive of VAT and delivery

Health Care Therapy

BoSo Pocket Laser 9000



boso
BOSCH + SOHN

- Active low output laser ideal for minor skin irritations
- Battery powered

BoSo 9000 £79.60
BoSo Pocket Laser

BoSo Infrared Therapy Lamps



boso
BOSCH + SOHN

- 100 or 150 watt IR bulb
- Functional design with stable platform
- 240v mains operation

BoSotherm 4000 £26.60

100w I.R. Therapy lamp

BoSotherm 4100 £39.80

150w I.R. Therapy lamp

BoSo Acupuncture 9100



boso
BOSCH + SOHN

- Needle free acupuncture
- Includes rechargeable batteries

BoSo 9100 £168.30
BoSo Acupuncture Laser

Hippo Humidifier - Steam Vaporiser



- Large capacity environmental humidifier
- Relieves bronchial disorders and promotes good respiratory health
- Stable and robust build quality
- The 5.5 litre tank is moulded from tough ABS plastic with hand-holds for manoeuvring
- Pull-out tray for aromatherapy oils
- External water level indicator
- Steam flow adjustment
- Safe to use with fused cut-out, complies with EN 60 335-2-98/A1 standard
- Up to 12 hours continuous use
- Substantial element system ensures the longevity of the unit
- Fitted with two pin plug only, requires adaptor

120.50.000 Hippo Humidifier £55.10

AW Medex Massager



- Large surface area massager for effective relief from muscular strain and injury
- Effective with all large muscle groups, especially back injuries
- Used by professionals and private patients alike
- Mains 240v powered
- Four-point vibration control ensures equal vibration across entire surface of pad
- Includes 2 hardwearing rubber pads, 1 x smooth and 1 x hyperaemisation
- Supplied in smart carrying case

100.10.000
AW Medex large surface area massager

£203.00

Your local medical supplier is just a phone call away. See cover for full details

Prices shown are exclusive of VAT and delivery

BoSo Heat Pads

A range of high quality heat pads ideal for localized heating, available in a range of sizes.

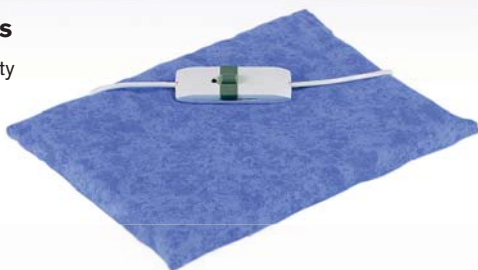

BoSoTherm 1200 30x40cm heat pad. 3 heat settings. 100w. Removable washable cover	£54.10
BoSoTherm 1400 33x44cm heat pad. 3 heat settings. 100w. Completely washable	£70.40
BoSoTherm 1500 30x40cm heat pad with timer control. 50w	£54.10

BoSo Back Pad



BoSo - 1300 Heated back pad with 60 minute timer. 56w	£64.30
---	---------------

BoSo Heated Blankets



BoSo 2000 130 x 75cm, 3 temperature positions. 50w	£56.10
BoSo 2100 150 x 80cm, large size. 60w	£78.60
BoSo 2200 150 x 80cm, large size with 90 minute timer. 60w	£100.00

AW Long Handled Nail Scissors

- Serrated nail scissors designed to cut tough nails that are difficult to reach
- Toe nails can be reached easier
- Serrated blades make light work of the thickest nails
- Made from stainless steel with autoclaveable plastic handles
- 20cm overall length
- Suitable for the elderly



99.05.070 AW Long Handled Nail Scissors	£6.10
--	--------------

Epicondylitis Clamps

- Safe and effective relief from the pain of tennis elbow
- Lightweight and comfortable to wear
- Allows instant relief and long-term healing
- Available in a large range of sizes



105.20.225 Epicondylitis Clamp 225mm - X-Small	£31.90
105.20.245 Epicondylitis Clamp 245mm - Small	£31.90
105.20.265 Epicondylitis Clamp 265mm - Med	£31.90
105.20.290 Epicondylitis Clamp 290mm - Large	£31.90
105.20.325 Epicondylitis Clamp 325mm - X-Large	£31.90

PRO-PIL-O

PRO-PIL-O Vario:

- Internationally known neck support pillow
- Soft contoured special foam keeps the head, neck and shoulders in a relaxed position during sleep

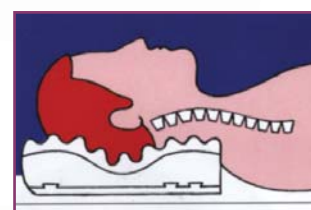
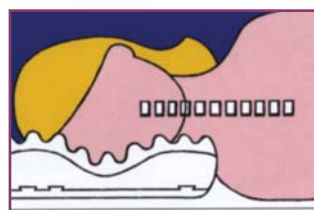

PPV1	£56.00
-------------	---------------

Clothing, Footwear & Aseptic Articles **Footwear**

Footwear

For more than 30 years the name of SCHÜRR has been associated with high quality, comfortable, footwear. Hand made in Germany for constant quality, we are proud to present just a small selection of Schurr Professional and Safety Shoes.

Ideal for the following areas:

- Operating theatres
- Laboratories
- Pharmacy
- Electronics departments

Chiro Clogs

Antistatic - with removable inner sole

- Crafted from polyurethane with a wide fitting for increased comfort
- Detachable and replaceable insoles makes this clog ideal for departmental use where large numbers of different people may use the same shoe body
- Individual users can be supplied with their own insoles for increased hygiene and reduce the risk of cross infection
- Worn, damaged or soiled insoles can be replaced quickly and cheaply
- Side ventilation holes ensure air circulation and prevent heat build up
- Available with or without heel strap
- Colour coding available for different areas
- All clogs can be marked with up to 6 letters or numbers
- Washable and disinfectable up to 70°C
- Shoe size embossed on heel for easy sorting and storing
- Tested to withstand all types of mechanical cleaning

Colours Available



White Green Blue Red Yellow

SCHÜRR®
PROFI SHOES

Handmade in Germany

Complete brochure available on request



Without heel strap



With heel strap

Chiro Clog *without* heel strap

Please state size required - sizes available 36 to 48

3 2250 00 80	White	£49.60
3 2251 00 80	Green	£49.60
3 2252 00 80	Blue	£49.60
3 2253 00 80	Red	£49.60
3 2254 00 80	Yellow	£49.60

Chiro Clog *with* heel strap

Please state size required - sizes available 36 to 48

3 2270 00 80	White	£49.60
3 2271 00 80	Green	£49.60
3 2272 00 80	Blue	£49.60
3 2273 00 80	Red	£49.60
3 2274 00 80	Yellow	£49.60

Individual marking 6 character maximum **£2.50**

3 0080 00 0 Replaceable insoles, please advise size **£12.30**

Shoe size comparison chart

Continental

36	37	37.5	38	39	39.5	40	40.5	41	42	42.5	43	43.5	44.5	45	46	47	48
3.5	4	4.5	5	5.5	6	6.5	7	7.5	8	8.5	9	9.5	10	10.5	11	12	13

United Kingdom

Your local medical supplier is just a phone call away. See cover for full details

Prices shown are exclusive of VAT and delivery

Chiro Clogs

Antistatic - with fixed inner sole

- The ideal comfortable clog for individual use
- Crafted from polyurethane with a wide fitting for increased comfort
- Integrated insole for the greatest comfort together with conductive stitching seams that are kind to the feet
- Side ventilation holes ensure air circulation and prevent heat build up
- Available with or without heel strap
- Colour coding available for different areas
- All clogs can be marked with up to 6 letters or numbers
- Washable and disinfectable up to 70°C
- Tested to withstand all types of mechanical cleaning
- Shoe size embossed on heel for easy sorting and storing



Chiro Clog with inner lining, without heel strap

Please state size required - sizes available 35 to 46

3 2350 00 80	White	£49.60
3 2351 00 80	Green	£49.60
3 2352 00 80	Blue	£49.60

Chiro Clog with inner lining, with heel strap

Please state size required - sizes available 35 to 46

3 2370 00 80	White	£49.60
3 2371 00 80	Green	£49.60
3 2372 00 80	Blue	£49.60

Individual marking 6 character maximum **£2.50**

Colours Available



Chiro Clogs - Antistatic - one piece without inner lining, washable and disinfectable up to 90°C

- Budget priced clog that is still very comfortable and durable
- Integrated non-slip sole for maximum wearing comfort
- Side ventilation holes ensure air circulation and prevent heat build up
- Only available without heel strap
- Colour coding available for different areas
- All clogs can be marked with up to 6 letters or numbers
- Washable and disinfectable up to 90°C
- Tested to withstand all types of mechanical cleaning
- Shoe size embossed on heel for easy sorting and storing

Washable and disinfectable up to 90°C

Colours Available



Chiro Clog, one piece construction without inner lining

Please state size required - sizes available 35 to 46

3 2450 00 80	White	£48.00
3 2451 00 80	Green	£48.00
3 2452 00 80	Blue	£48.00
3 2453 00 80	Red	£48.00
Individual marking	6 character maximum	£2.50

Your local medical supplier is just a phone call away. See cover for full details

Prices shown are exclusive of VAT and delivery

Clothing, Footwear & Aseptic Articles **Footwear**

Schurr Classic Safety and Style, Non Antistatic

Incorporating Schurr's unique 3 phase damping for improved comfort.

The heel area of any shoe generates enormous pressures which lead directly from the foot to the spine. Schurr's 3 phase damping incorporates:

- DRY TEC PUR insole to optimise the foot climate
- Technogel shock absorbing pad
- Latex pad in the midsole
- Very comfortable
- Leather inner lining
- Replaceable inner sole made from PUR foam



Slip on



With front fastening Velcro strap



Replaceable inner sole

Slip on with 3 phase damping

Please state size

1 1434 01 11 White only, size 36 - 40 **£89.40**

1 1334 01 11 White only, size 41 - 46 **£89.40**

With front fastening Velcro strap, with 3 phase damping

1 1433 01 11 White only, size 36 - 40 **£89.40**

1 1333 01 11 White only, size 41 - 46 **£89.40**

Replaceable inner soles

5 0017 00 00 Washable up to 30°C, size 36 - 40 **£7.70**

5 0027 00 00 Washable up to 30°C, size 41 - 46 **£7.70**

Classic

- Professional shoes certified to DIN EN347-1
- Comfortable with leather coated cork footbed
- Anti slip K4 sole

E class

- Safety shoes according to DIN EN 345-1 S1 and S2
- Tough upper leather
- Lining from genuine leather
- Comfortable formed steel toe cap
- Twice coated PU sole



Classic - with heel strap

Classic - with C1 anti slip sole



E class - slip on

E class - lace up

Classic with heel strap

Please state size

1 1410 09 24 Grey only, female, size 35 - 41 **£66.10**

1 1310 09 24 Grey only, male, size 39 - 47 **£66.10**

Classic with C1 anti slip sole and rear/front strap

Please state size

1 1404 01 11 White only, size 35 - 40 **£72.30**

1 1304 01 11 White only, size 41 - 48 **£72.30**

E class lace up

2 0352 01 00 White only, size 36 - 48 **£62.50**

E class slip on

2 0967 01 11 White only, size 36 - 48 **£62.50**

Shoe size comparison chart

Continental

36 37 37.5 38 39 39.5 40 40.5 41 42 42.5 43 43.5 44.5 45 46 47 48

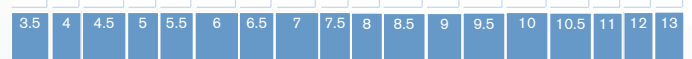

United Kingdom

Your local medical supplier is just a phone call away. See cover for full details

Prices shown are exclusive of VAT and delivery

Clothing

Standard Face Mask

- 3 layer surgical face mask with integral plastic brace for perfect anatomical shaping
- Non irritating, odourless soft material that is gentle to the skin
- Free from glass fibres, latex and other allergenic substances
- Bacterial filtration greater than 98.1%
- Supplied with loops or ties
- Standard colour blue; green or white available upon request



Standard Face Mask with ties 20270

M001 **£5.70**
Standard Face Mask with ties
Available in blue as standard, pack of 50



Standard Face Mask, with loops 20272

M005 **£11.50**
Standard Face Mask with loops
Available in blue as standard, pack of 100

Shoe Covers



- Made from plastic foil with elasticated edges and non slip surface

Shoe Covers
AW1131883 Shoe covers Pack of 100 **£8.00**



Protective Apron

- Simple impervious apron made from PE foil
- Ties at the rear
- Length 125cm

Protective Apron
AW1131833 **£9.20**
Apron in white Pack of 100

Aseptic Articles

Surgical Drapes Sterile - Plain

- Surgical drape made from hydrophobic non woven textile type SMS
- Used mainly for minor surgery with low fluid leak
- Single packed
- Sterile

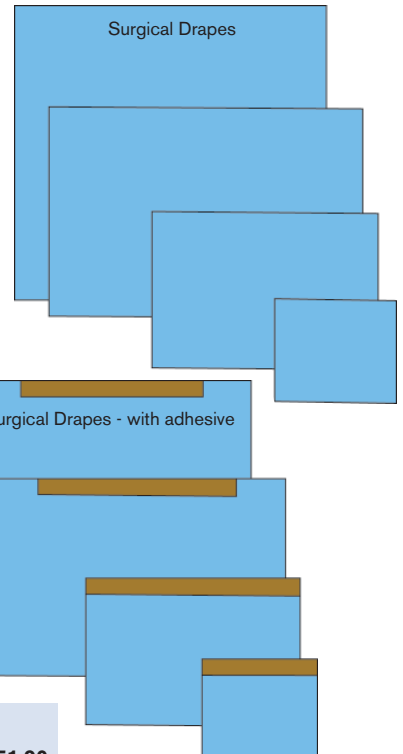

Surgical Drapes
10.0103.S **£51.90**
75 x 75cm Pack of 10
10.0203.S **£71.90**
75 x 75cm with adhesive
Pack of 10
10.0105.S **£57.90**
75 x 120cm Pack of 10
10.0205.S **£52.50**
75 x 120cm with adhesive
Pack of 10

10.0106.S **£98.20**
150 x 180cm Pack of 10
10.0206.S **£109.60**
150 x 180cm with adhesive
Pack of 10

Your local medical supplier is just a phone call away. See cover for full details

Prices shown are exclusive of VAT and delivery

Human Skeleton "Willi"

- Life-size male skeleton, cast from unbreakable plastic
- All fissures, foramina and other details are faithfully reproduced
- Skull can be dismantled into 3 pieces
- Special articulation of rib cage guarantees preservation of shape
- Joint movement can be demonstrated naturally
- Arms, legs and skull can be detached
- Includes mobile castor base and protective dust cover
- Height 176cm
- Weight 9.5kg



3001
Human Skeleton "Willi", life-size

£485.70

Human Skull



- Full size human skull cast from unbreakable plastic
- Can be separated into 3 parts: calvarium, base and mandible
- Particular attention is paid to the true-to-life reconstruction of the dentition
- It is practically impossible to distinguish between this model and natural dentition, largely due to the articulation of the Temporal-mandibular joint

4503
Human Skull, in 3 parts

£95.00

Dental Skull

- Skull can be dismantled in to 4 parts
- The teeth in the upper and lower mandible can be extracted and reinserted
- The lower mandible is open and shows roots, spongiosa, nerve canal and impacted wisdom tooth
- Size 22 x 13 x 17cm



4513
Dental Skull

£137.30

Mini Skeleton "Patrick"

- Miniature skeleton in fine detail
- Approx. one third life size
- All arm and leg joints are articulated for demonstration of joint movement
- Skull is divided into 3 parts
- Available with or without muscle attachments shown ("Little Jim")
- Supplied on stand for demonstration
- Height for Patrick and Jim 65cm
- Weight for Patrick and Jim each, 0.5kg

3030
Mini Skeleton "Patrick"

£298.00

3035
Mini Skeleton "Little Jim", showing muscle attachments

£468.30



Your local medical supplier is just a phone call away. See cover for full details

Prices shown are exclusive of VAT and delivery

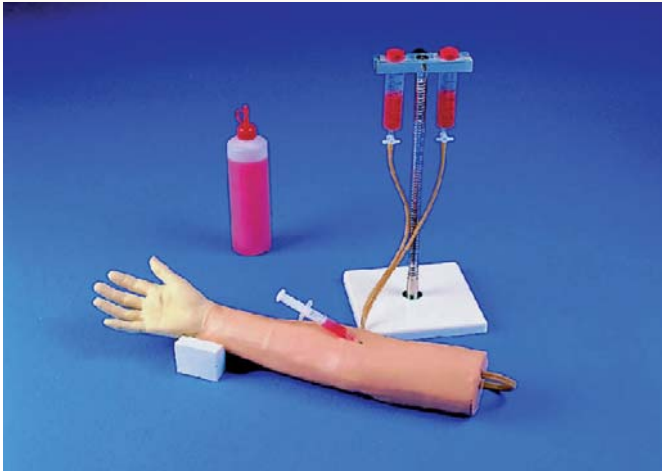

Injection Training Arm with Hand

- Invaluable training model for drawing blood, IV injections and infusion techniques
- Suitable when training medical students, nurses, anaesthetist etc.
- The model is a life-cast showing veins in fine detail
- Skin is made from plastic specially selected to allow natural palpation of the veins
- Includes: Injection training arm, powdered blood simulator, syringe and IV system, bottle and stands

7010	Injection Training Arm, complete	£213.40
7014	Replacement blood	£5.25
7022	Replacement veins	£12.90

Skin Acne Model

- Enlarged cross section of skin
- Relief detail shows acne pistula (pimple)
- Reverse detail shows open comedo (blackhead)
- Also shown are Epidermis, Dermis & Subcutaneous tissue details of normal skin
- 10 x 10 x 11.5cm

J50 Skin Acne Model **£80.00**



Skin Cancer Model

- This model shows three cancerous conditions;
- Nodular Basal Cell
- Malignant Melanoma
- Morpheic Basal Cell

And three non cancerous conditions;

- Dyplastic Nevi
- Keratoacanthoma
- Basal layer and dermal layer cross sectional detail
- 11.5 x 11.5 x 3cm



J55 Skin Cancer Model **£77.00**

Your local medical supplier is just a phone call away. See cover for full details
Prices shown are exclusive of VAT and delivery

Human Spine

- Life size human spine and pelvis in unbreakable plastic cast from a human spine for exact detail
- Spinal cord together with emerging spinal nerves and arteria vertebralis are all faithfully represented
- Incorporates an unbreakable flexible metal rod for demonstration of the cooperation between vertebrae, discs and nerves
- Life-like reaction of disks when articulating the spine in all directions
- Complete with demonstration stand
- Also available in a mini version



4009 Human Spine, on stand

£210.30

Shoulder Joint with Ligaments



- Natural casting of a human shoulder joint. Shoulder girdle (shoulder blade and clavicle) with upper arm stump
- The principal ligaments are represented in addition to sections of the joint capsule
- The main movements of the shoulder joint, such as anteversion, retroversion, outer and inner rotation and abduction can be demonstrated

4550 Shoulder Joint with Ligaments

£72.60

Knee with Ligaments

- Natural casting of a human knee joint, with stumps of femur and lower leg
- The insertion tendons of the straight muscle of the thigh, kneecap with patella tendons lateral ligaments, meniscae and cruciate ligaments are manufactured from elastic synthetic material
- The principal movements of the knee joint, such as flexion and extension and outer and inner rotation can be demonstrated
- On removable stand



4552 Knee Joint with Ligaments

£72.60

Miniature Joints with Joint Cross-Section



- Individual miniature joint models on stands, with cross section of the respective joint fixed to the stand
- Approximately half natural size
- Choose from hip, knee or shoulder
- Allows demonstration of the action of each particular joint and assists in the explanation of problems and conditions
- Each model's dimensions 160 x 120 x 200mm

4523 Miniature Hip Joint, on stand

£33.20

4522 Miniature Knee Joint, on stand

£33.20

4520 Miniature Shoulder Joint, on stand

£33.20

Your local medical supplier is just a phone call away. See cover for full details

Prices shown are exclusive of VAT and delivery

Eye Model



- Enlarged approx. 3 times and dissectible into 6 parts, this detailed model of the eye is ideal for demonstration of most ophthalmic conditions
- Includes: Sclera with cornea and muscle insertions, vascular tunic with iris, vitreous body with retina and lens
- Size 9 x 9 x 15cm
- Mounted on convenient stand, for demonstration and storage
- Also available mounted in complete orbita, showing the 5 muscles of the eyeball, on stand

F210 Eye Model in Orbit, 7 Parts **£52.00**

Shoulder with Ligaments and Muscles

- Natural size
- Ligamentary apparatus
- Infraspinatus muscle
- Teres minor muscle
- Teres major muscle
- Subscapular muscle
- Supraspinatus muscle
- Size 12.5 x 15.5 x 14cm
- Stand mounted



4661 Shoulder with Ligaments and Muscles **£91.50**

Hip with Attachments

- Natural size
- Ligamentary apparatus and obturator externus muscle
- Gluteus medius muscle
- Gemellus inferior and superior muscles
- Iliac muscle with portion of psoas major muscle
- Size 12 x 14.5 x 19cm

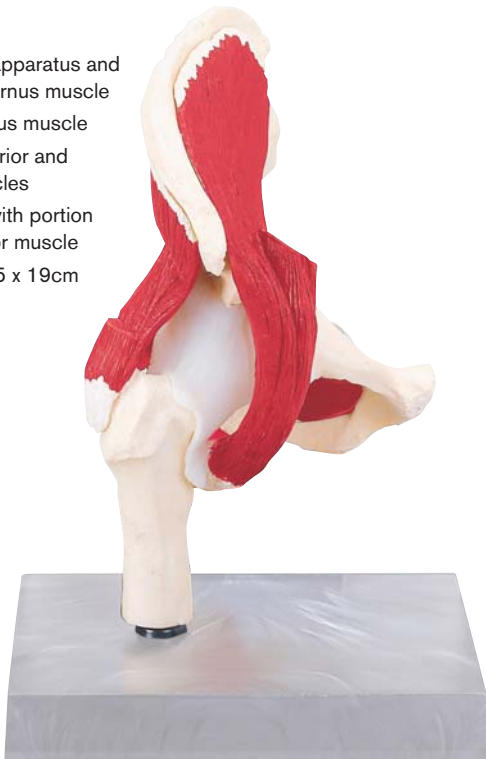

4663 Hip with Attachments **£91.10**

Hip Joint with Ligaments

- Natural casting of a human hip joint
- The femoral stump is retained in the hip joint by the ligamentary apparatus
- Allows demonstration of the hip joint
- On removable stand



4553 Hip with Ligaments **£79.00**

Your local medical supplier is just a phone call away. See cover for full details
 Prices shown are exclusive of VAT and delivery

Index

A		
Abi System	70, 242	
Acupuncture	288	
Adson Forceps	126	
Airways	225	
Airways - Guedal	225	
Alcohol Hand Rubs	281	
Alcohol Swabs	134	
Allergy Lancets	287	
Amplivox Audiometers	272	
Ampoule Holders	101	
Aneroids	64 - 69	
Ankle Brachial Index System	70, 242	
Antibacterial Wipes	134	
Applicators - Wooden	134	
Aprons	293	
Arm & Leg Supports	168	
Artery Forceps	127	
Artery Forceps - Crile	127	
Artery Forceps - Halstead Mosquito	127	
Artery Forceps - Spencer Wells	127	
Aseptic Articles	293	
Askina Skin Freezer	123	
Aspirators	210 - 213	
Asthma Monitors	261	
Audiocups	273	
Audiometers	272	
Aural Syringe	129	
Auxiliary Trolley	169 - 173	
Ayres Spatulas	115	
B		
Baby And Toddler Scales	194	
Baby Changing Units	174	
Baby Measures	201	
Baby Measuring Mat	201	
Back Pad	289	
Bags & Cases	94 - 101	
Bandage Applicators	137	
Bandage Scissors	124	
Banding Instruments	116	
Bands Ligator	116	
Basin Holder	182	
Bath Thermometers	90	
Batteries	38, 49, 58	
Bed Scales	197	
Bihex Ligator	116	
Bins - Sharps	285	
Biopsy - Blades	108	
Biopsy - Punches	109	
Block End Forceps	126	
Blood Analysis	286 - 287	
Blood & Urine Analysis	286 - 287	
Blood Collection	284	
Blood Lancets	287	
Blood Pressure Accessories	77	
Blood Pressure Cuffs	77	
Blood Pressure Monitors	64 - 77	
Blood Pressure Monitors - Boso	64 - 69, 71 - 77	
Blood Pressure Monitors - Guardian	64, 66 - 69, 74 - 75, 77	
Blood Tester	287	
Bollmann - Document Folder	101	
Bollmann Ampoule Holder - Clear View	101	
Bollmann Ampoule Holder - Compact	101	
Bollmann Ampoule Holder - Leather	101	
Bollmann Cases	94 - 101	
Bollmann Cases - Alternative	99	
Bollmann Cases - Assista	95	
Bollmann Cases - Care Case	98	
Bollmann Cases - Classic	97	
Bollmann Cases - Concertina	97	
Bollmann Cases - Easycare	99	
Bollmann Cases - Leather Instrument	101	
Bollmann Cases - Med 1 Gp	100	
Bollmann Cases - Med 16 Gp Supreme	100	
Bollmann Cases - Med 8 Gp Deluxe	100	
Bollmann Cases - Medica 2000	94	
Bollmann Cases - Medicare	98	
Bollmann Cases - Medicus	99	
Bollmann Cases - Medistar	95	
Bollmann Cases - Nova	96	
Bollmann Cases - Piccola	94	
Bollmann Cases - Practicus	95	
Bollmann Cases - Progress	96	
Bollmann Cases - Promed Bag	98	
Bollmann Cases - Visita	94	
Boso - Accupuncture	288	
Boso - Aneroid	64 - 69	
Boso - Back Pad	289	
Boso - Blood Pressure Monitors	64 - 69, 71 - 77	
Boso - Heated Blankets	289	
Boso - Heated Blankets	289	
Boso - Infrared Therapy Lamps	288	
Boso - Sphygmomanometers	64 - 69, 71 - 77	
Bowls - Kickabout	182	
Braun - Thermoscan	89	
Brushes - Cervical	114	
Brushes - Gynaecology	114 - 115	
Bulbs	50 - 51	
Bulbs - 2G Guardian Generica	51	
Bulbs - Generic Heine	50	
Bulbs - Generic Keeler	51	
Bulbs - Generic Welch Allyn	51	
C		
Cabinets - Drug Controlled	186	
Callipers	90	
Cannula	265	
Carbon Monoxide Testers	256 - 257	
Caretray Trolleys	184	
Cases - Bollmann	94 - 101	
Cases - Doctor	94 - 101	
Cases & Bags	94 - 101	
Cautery	118 - 121	
Cautery - Accessories	118 - 121	
Cautery - Battery Operated	120 - 121	
Cautery - Light Duty Model	120 - 121	
Cautery - Mains Units	118	
Cautery - Rechargeable Units	119	
Cervical Brushes	114 - 115	
Chairs - Arm & Leg Support	168	
Chairs - Gynaecology	164	
Chairs - Haemo	168	
Chairs - Minor Ops	164	
Chairs - Phlebotomy	168	
Chairs - Scales	196 - 197	
Chairs - Treatment	164	
Chairs & Stools	168, 175 - 176	
Changing Table	174	
Chiropody - Chisel	130	
Chiropody - Excavator	130	
Chiropody - File	130	
Chiropody - Gouge	130	
Chiropody - Probe	130	
Chiropody - Scoop	130	
Chiropody - Spatula	130	
Chiropody Instruments	130	
Clamps Epicondylitis	289	

Class III Scales	193 - 198	Desk Chargers - Standard	38	Disposable - Scissors	124 - 125
Cleaner - Surface	280 - 283	Devilbiss Vacuaide	212	Disposable - Shoe Covers	293
Cleaning Brushes	131	Diagnostic Sets 11, 13, 18, 20, 24 - 29, 33		Disposable - Skin Marking Pens	107
Clinitek Blood And Urine Analysis	286	Diagnostic Sets - Accessories 35, 37 - 43		Disposable - Sponge Forceps	113
Clogs	290 - 292	Diagnostic Sets - Battery 13, 18, 24, 28, 33		Disposable - Swabs	134
Clothing	293	Diagnostic Sets - Desktop 14, 25, 29, 34		Disposable - Thermometers	89
Co Monitors	256 - 257	Diagnostic Sets - Ent 28 - 29		Disposable - Thudichum Nasal Specula	129
Colour Blindness Test	45	Diagnostic Sets - Fibre Optic 11, 13, 18, 20, 24 - 29, 33		Disposable - Urine Cups	134
Column Scales	195, 198 - 199	Diagnostic Sets - Led 11, 13, 18, 20, 24 - 29, 33		Disposable - Vaginal Speculum 110 - 113	
Controlled Drugs Cabinet	186	Diagnostic Sets - Lithium Ion 24 - 25, 28 - 29, 32 - 33		Dissecting Forceps	126
Couch - Covers	166	Diagnostic Sets - Mini 11, 13, 18		Dissecting Instrument Set	135
Couch - Accessories	166	Diagnostic Sets - Ophthalmic 33 - 34		Dissector - Mcdonald	128
Couch - Electric	163	Diagnostic Sets - P1 18		Doctors Cases	94 - 101
Couch - Examination	156 - 163	Diagnostic Sets - P2 11, 13, 17		Document Folder	101
Couch - Fixed Height	156 - 161	Diagnostic Sets - Practice 24 - 27		Dopplers	243 - 245
Couch - Fold Away	161	Diagnostic Sets - Rechargeable 14, 24 - 25, 28 - 29, 33		Dressing Scissors	124
Couch - Gynaecology	164	Diagnostic Sets - S1 24 - 27		Dressing Trolley	169 - 173
Couch - Height Adjustable	162 - 163	Diagnostic Sets - Standard 24 - 27		Drip Poles	187 - 189
Couch - Roll Holder	166	Diagnostic Sets - Stations 17, 26 - 27, 34		Drip Stands	187 - 189
Couch - Rolls	277	Diagnostic Sets - USB 24, 28, 33		Drug Cabinets	186
Couch - Steps	166 - 167	Diagnostic Sets - Wall Mounted 17, 26 - 27, 34		Drug Dispensing Trolleys	184
Couches	156 - 163	Digital Thermometers	88 - 89	E	
Covers - Couch	166	Disinfectant	280 - 283	Ear Care Stations	9, 17, 35
Covers - Washable	166	Dispenser - Hand Towel	276 - 277	Ear Irrigator (Electric)	
Cryosurgery	123	Dispenser - Soap	281 - 282	Single Patient Ear Tips	135
Cuffs - Blood Pressure	77	Dispenser - Toilet Roll	276	Ear Noots Tank	135
Curettes	108	Disposable - Aprons	293	Ear Syringe (Electric)	
Cuscos - Disposable	110 - 113	Disposable - Cuscos	110 - 113	- Clean Tablets	135
Cuscos - Vaginal Speculum	110 - 113	Disposable - Drapes	293	Ear Syringe (Electric)	
Cylinder Trolley	183	Disposable - Ent	129	Single Patient Ear Tips	135
D		Disposable - Face Mask	293	Ear Thermometer	88 - 89
Defibrillators	220 - 221	Disposable - Finger Cots	134	Ear Thermometer - Braun	89
Dermatology	102 - 109	Disposable - Guedel Airways	225	Ear Tips	135
Dermatology Accessories	106 - 109	Disposable - Hegar Dilator	110	Ear Tips - 2G Guardian Generica	46 - 49
Dermatology Curettes	108	Disposable - Instruments	124 - 129	Ear Tips - Dispensers	9, 17
Dermatology Instrument Set	133	Disposable - Kidney Dish	135	Ear Tips - Kawe Generic	49
Dermatology Punches	109	Disposable - Laryngoscopes	208 - 209	Ear Tips - Keeler Generic	47
Dermatoscope Accessories	104	Disposable - Needle Holder	125	Ear Tips - Keeler Generic	47
Dermoscopes	102 - 105	Disposable - Noots Ear Tank	135	Ear Tips - Opticlar	35
Dessicator	122	Disposable - Pen Torch	91	Ear Tips - Riester Generic	49
Desk Chargers	14, 38	Disposable - Razors	134	Ear Tips - Welch Allyn Generic	48
Desk Chargers - Mini	14	Disposable - Resuscitators	222 - 223	Earlight	39
Desk Chargers - Ophthalmic Sets	38			ECG - Accessories	238 - 241
Desk Chargers - Ophthalmoscopes	38			ECG - Cardioline Machines	226 - 227, 230, 232, 236 - 237
Desk Chargers - Otopscopes	14, 38			ECG - Connectors And Clips	238 - 239
Desk Chargers - P2	14			ECG - Electrodes	238 - 239
				ECG - Gel	239

Index

ECG - Kenz Machines	228 - 229, 231, 233 - 235	Forceps - Allis Tissue	126	Gloves - Latex	274
ECG - Machines	226 - 237	Forceps - Artery	127	Gloves - Nitrile	275
ECG - Paper	240 - 241	Forceps - Block End	126	Gloves - Vinyl	274
ECG - Ruler	239	Forceps - Bozemann Swabs	113	Gouge - Chiropody	130
ECG - Trolleys	238	Forceps - Crile	127	Gross Hook	129
Electric Couch	163	Forceps - Dissecting	126	Guardian - Aneroids	64 - 69
Electronic Stethoscopes	85	Forceps - Dunhill	127	Guardian - Examination Gloves	274 - 275
Electrosurgery	122	Forceps - Epilation	126	Guardian - Guedel Airways	225
Emergency Eye Irrigation	217	Forceps - Gillies	126	Guardian - Pulse Oximeter	214 - 215
Epicondylitis Clamps	289	Forceps - Halstead Mosquito	127	Guardian - Resuscitation Kit	222
Epilation Forceps	126	Forceps - Hartmann Crocodile	129	Guardian - Resuscitators	222 - 223
Equipment Trolleys	169 - 173	Forceps - Hunter Splinter	126	Guardian - Stethoscopes	80 - 87
Examination Couches	156 - 163	Forceps - Iris	126	Guardian - Tourniquets	218 - 219
Examination Gloves	274 - 275	Forceps - Kocher	127	Guedel Airways	225
Examination Gloves - Box Holder	275	Forceps - Lane	126	Gynaecology Couches	164
Examination Gloves - Latex Free	275	Forceps - Lister Sinus	129	Gynaecology Scissors	113
Examination Gloves - Latex Powder Free	274	Forceps - Luer Vulsellum	113	Gynobrush Special	115
Examination Gloves - Latex Powdered	274	Forceps - Magill	129	H	
Examination Gloves - Nitrile	275	Forceps - Martin Splinter	126	Haemorrhoid Banding Instruments	116
Examination Gloves - Vinyl	274	Forceps - Mayo	127	Haemorrhoid Litagator	116
Examination Lamps	138 - 153	Forceps - McIndoe	126	Halstead Mosquito Forceps	127
Eye Test Charts	45	Forceps - Model USA	126	Hand And Wrist Splint	224
F		Forceps - Quire	129	Hand Held Aneroids	64 - 65
Face Masks	293	Forceps - Rampley Sponge Holding	113	Hand Soap	280 - 283
Face Shields	225	Forceps - Schroeder Vulsellum	113	Hand Towels - C Fold	276
Falk Pessary	114	Forceps - Sinus	129	Hand Towels - Dispensers	276 - 277
Fibre Optic - Diagnostic Sets	11, 13, 18, 20, 24 - 29, 33	Forceps - Spencer Wells	127	Hand Towels - Rolls	276
Fibre Optic - Headlights	60 - 61	Forceps - Sponge	113	Handles - Adapt Metal	37
Fibre Optic - Laryngoscopes	206 - 209	Forceps - Teale Vulsellum	113	Handles - Battery	37
Fibre Optic - Oscopes	8, 11, 15, 22 - 23	Forceps - Tilley	129	Handles - E Lithium	37
Fibre Optic - Proctoscopes	116	Forceps - Treves	126	Handles - Mini	37
File - Chiropody	130	Forceps - Tubing Clamp	127	Handles - Ophthalmoscope	37
Filters - Sigmoidoscope	117	Forceps - Turnover End	126	Handles - Oscope	37
Finger Cots	134	Forceps - Watchmaker	126	Handles - Standard	37
Finger Pulse Oximeters	214 - 215	Forceps - Wilde Aural	129	Handles - Usb	37
Floor Scales	192 - 193	Freezers	204	Hartmann Forceps	129
Flow Meters	260 - 261	Furniture	156 - 191	Head Mirror	129
Fob Watches	93	Furniture - Waiting Room	191	Headlamps	58 - 63
Foetal - Doppler	245	G		Headlight Systems	56 - 63
Foetal - Stethoscopes	86	Gel - ECG	239	Headlights	58 - 63
Fold Away Couch	161	Gillies Forceps	126	Headlights - Fibre Optic	60 - 61
Foot And Ankle Splint	224	Gillies Needle Holder	125	Headlights - Led	58 - 59
Footwear	290 - 292	Gillies Skin Hook	128	Headsets	273
Forceps	126 - 127	Glove Box Holders	275	Heat Pads	289
Forceps - Adson	126	Gloves - Examination	274 - 275	Heated Blankets	289
		Gloves - Holders	275	Hegar Dilator	110

Height Adjustable Couches	162 - 163	Kai Biopsy Punches	109	Lights - Loupe	56 - 59
Height Measures	198 - 200	Kai Curettes	108	Lights - Magnifying	154 - 155
Holloware - Plastic	136	Kawe Spares And Accessories	49, 51	Lights - Mobile	138 - 155
Holloware - Stainless Steel	137	Kawe Specula	49	Lights - Operating	140
Humidifier	288	Keeler Bulbs	51	Lights - Reading	151
Hyfrecator & Accessories	122	Keeler Specula	47	Lights - Surgery	140
Hygiene Centre	285	Kenz ECG Machines	228 - 229, 231, 233 - 235	Lister Forceps	129
I		Key Fob Face Mask	225	Lister Scissors	125
Illuminated Test Charts	45	Kickabout Bowl	182	Littmann Stethoscope - Accessories	87
Inflatable Splints	224	Kidney Dishes	136	Littmann Stethoscopes	80 - 87
Infrared Lamps	288	Kilner Needle Holder	125	Long Handled Scissor	289
Infrared Thermometers	88 - 89	L		Loupe Lights	56 - 59
Infusion Accessories	189	Lamps - Examination	138 - 153	Loupes	52 - 55
Infusion Stands	187 - 189	Lamps - Head	58 - 63	M	
Inhalers	259	Lamps - Magnifying	154 - 155	Magill Forceps	129
Injection Training Arm	295	Lancets - Allergy	287	Magnifiers - Hand Held	106
Instrument Cases	101	Lancets - Blood	287	Magnifying Lights	154 - 155
Instrument Cleaner	131	Lancets - Minilet	287	Massager	288
Instrument Pouch	101	Lancets - Safety	287	Mayo Needle Holder	125
Instrument Set - Cusco	112	Lancing Device	287	Mayo Scissors	124
Instrument Set - Dermatology	133	Lane Forceps	126	Mayo Table	182 - 183
Instrument Set - Dissecting	135	Laryngeal Mirror	129	McDonald Dissector	128
Instrument Set - I.U.C.D	112	Laryngoscopes	206 - 209	McGivney Ligator	116
Instrument Set - Minor Surgery	132	Latex Gloves - Powder Free	274	McIndoe Forceps	126
Instrument Set - Scissor	132	Latex Gloves - Powdered	274	Measure Tape	90
Instrument Set - Suture	133	LED - Diagnostic Sets	11, 13, 18, 20, 24 - 29, 33	Measures	198 - 200
Instrument Set - Vaginal Speculum	112	LED - Earlight	39	Measuring Jug	136
Instrument Tables	182 - 183	LED - Headlights	56 - 59	Measuring Mat	201
Instrument Tray	136	LED - Ophthalmology Sets	33 - 34	Medical Screens	177 - 179
Instrument Trolleys	182 - 183	LED - Ophthalmoscopes	11 - 12, 15, 23, 31	Metzenbaum Scissors	125
Instrument Warmer	131	LED - Otoroscopes	8 - 11, 15, 22	Microlab - Spirometry	246 - 247, 250 - 251, 254
Instruments	124 - 130	LED - Retinoscopes	32, 43	Microscope	44
Insufflation Bulb	117	Leg Splints	224	Minor Ops Chair	164
Insufflation Filters	117	Lens - Morgan	217	Minor Surgery Set	132
Interacoustic Audiometers	272	Ligator Sets	116	Mirror - Laryngeal	129
Internal And External Calliper	90	Light - Infrared	288	Mirror - Ziegler Head	129
Iris And Strabismus Scissors	125	Light - Laser	288	Mirror Warmer	131
Iris Forceps	126	Light - Therapy	288	Mobile Screens	177 - 178
Irrigation - Eye	217	Light Therapy	288	Model USA Forceps	126
Ishihara Tests	45	Lighting	138 - 155	Model USA Scissors	125
IUCD Instrument Set	112	Lights - Ceiling	145	Models	294 - 297
IV Poles (Intensive Care System)	189	Lights - Examination	138 - 153	Monitors - Asthma	261
J		Lights - Floor	138 - 153	Monitors - Co2	256 - 257
Jobson Horne Probe	129	Lights - Headlights	56 - 63	Morgan Lens	217
K				Mosquito Forceps	127
Kai Biopsy Blades	108			Mouthpieces	261 - 263

Index

N		
Nail Brushes	131	
Nail Nippers	130	
Nail Scissors	130	
Nasal Speculum	129	
Nebulisers	266 - 271	
Needle Holders	125	
Needle Holders - Crile Wood	125	
Needle Holders - Derf	125	
Needle Holders - Disposable	125	
Needle Holders - Gillies	125	
Needle Holders - Kilner	125	
Needle Holders - Mayo Hegar	125	
Needle Holders - Olsen Hegar	125	
Needles - Blunt Fill	284	
Needles - Microlance	284	
Noots Ear Tanks	135	
Nose Clips	262	
O		
Olsen Hegar Needle Holder	125	
Operating Lights	140	
Ophthalmic Sets	33 - 34	
Ophthalmoscopes	11 - 12, 15, 23, 30 - 31	
Opticlar - Batteries	38	
Opticlar - Dermatoscopes	102 - 104	
Opticlar - Diagnostic Sets	13, 18, 24 - 29, 32 - 33	
Opticlar - Ear Care Stations	9, 17, 35	
Opticlar - Earlight	39	
Opticlar - Examination Lights	138 - 139	
Opticlar - Handles	37	
Opticlar - Head Accessories	41	
Opticlar - Headlights	56 - 63	
Opticlar - Heads	39 - 40, 42 - 43	
Opticlar - Laryngoscopes	206 - 209	
Opticlar - Loupe Lights	52 - 55	
Opticlar - Loupes	52 - 55	
Opticlar - Mini Sets	11, 13, 18	
Opticlar - Ophthalmic Sets	31, 33 - 34	
Opticlar - Ophthalmoscopes	11 - 12, 15, 23, 30	
Opticlar - Oscopes	8 - 9, 11, 15, 22	
Opticlar - Power Supplies	37 - 38	
Opticlar - Rechargeable Sets	14	
Opticlar - Rechargers	14, 38	
Opticlar - Retinoscopes	30, 32	
Opticlar - Specula	35	
Opticlar - Standard Sets	24 - 25	
Opticlar - Tip Dispensers	17, 35	
Opticlar - Tips	17, 35	
Opticlar - Wall Units	26 - 27, 36	
Otoscopies	6 - 9, 11, 15, 22 - 23	
Otoscopies - Accessories	35, 37, 39, 41	
Otoscopies - Battery	8 - 9, 11, 15, 22	
Otoscopies - Conventional	8	
Otoscopies - Desktop	14, 22	
Otoscopies - Direct Illumination	8	
Otoscopies - Handles	37	
Otoscopies - Led	8 - 11, 15, 22	
Otoscopies - Lithium Ion	22	
Otoscopies - Mini	8 - 9, 11, 15	
Otoscopies - P1	15	
Otoscopies - P2	11	
Otoscopies - P3	8	
Otoscopies - Practice	22	
Otoscopies - Rechargeable	14, 22	
Otoscopies - S1	22	
Otoscopies - Standard	22	
Otoscopies - Stations	9	
Otoscopies - Tips	35, 46 - 49	
Otoscopies - Tips Dispensers	35	
Otoscopies - USB	22	
Otoscopies - Wall Mounted	22	
Otoscopies- Fibre Optic	8, 11, 15, 22 - 23	
Otoscopies- Heads	39	
Oximeters - Pulse	214 - 215	
Oxygen Administration Kit	216	
Oxygen Cannula	265	
Oxygen Concentrators	264	
Oxygen Cylinder Trolleys	183	
Oxygen Masks	216, 265	
P		
Paper - ECG	240 - 241	
Paper & Hand Towels	276	
Paramedic Pouches	224	
Patient Trolleys	165	
Peak Flow Meters	260 - 261	
Pen Torches - Disposable	91	
Pen Torches - Re-Usable	91	
Perasafe	262	
Percussors	92	
Pessary	114	
Pharmacy Cabinets	186	
Pharmacy Refrigeration	202 - 205	
Pharmacy Trolley	182 - 183	
Phlebotomy Chair	168	
Physiotherapy Instruments	92	
Pico + Smokerlyzer	257	
Pillows	289	
Pinard Foetal Stethoscopes	86	
Plastic Holloware	136	
Pocket Masks	223	
Portable Refrigeration	204	
Portable Suction Pumps	210 - 213	
Posture Stools	175 - 176	
Practitioner Stools	175	
Prameta Tourniquets	219	
Privacy Screens	177 - 179	
Probe Covers - Thermoscan	89	
Probrush Cervical Sampling Brush	114	
Probrush Spatula And Brush	114	
Proctology Instruments	116 - 117	
Proctoscopes	116 - 117	
Prospec Cuscos	110 - 111	
Prospec Disposable Hegar Dilators	110	
Prospec Disposable Proctoscope	116 - 117	
Prospec Disposable Vaginal Speculum	110 - 111	
Prospec Sims Disposable Uterine Sounds	110	
Prospec Sims Disposable Vaginal Speculum	110	
Prospec Thread Retriever	115	
Protective Apron	293	
Protective Clothing	293	
Provita - Infusion Stands	187 - 189	
Provita - Lights	140 - 153	
Provita Hygiene Centre	285	
Pulp Kidney Dish	135	
Pulse Oximeters	214 - 215	
Punches - Biopsy	109	
R		
Ramplly Sponge Forceps	113	
Razors	134	
Reading Charts	45	
Rechargeable Cautery	119	
Rechargers	14, 38, 65	
Rechargers - Dermatoscopes	103	
Rechargers - Diagnostic Sets	14, 38	
Rechargers - Ophthalmoscopes	14, 38	

Rechargers - Otosopes	14, 38	Scissors - Lister	125	Specula - Generic Kawe	49
Refrigeration	202 - 205	Scissors - Littauer	125	Specula - Generic Keeler	47
Refrigerator Thermometers	90	Scissors - Long Handled	289	Specula - Generic Riester	49
Refuse Bag Holders	185	Scissors - Mayo	124	Specula - Generic Welch Allyn	48
Respiratory Accessories	262 - 263	Scissors - Metzenbaum	125	Specula - Guardian Generica	46 - 49
Resuscitators	222 - 223	Scissors - Model USA	125	Specula - Opticlar	35
Resuscitation Kit	222	Scissors - Nail	130	Specula - Otosopes	35, 46 - 49
Resuscitation Mask	223	Scissors - Set	124	Speculum - Cusco	110 - 113
Retinoscope	32 - 33	Scissors - Sims	125	Speculum - Nasal	129
Retractors	128	Scissors - Spencer Stitch	125	Speculum - Thudicum	129
Retractors - Double Hook	128	Scissors - Strabismus	125	Speculum - Vaginal	110 - 113
Retractors - Kilner	128	Scissors - Tough Cut	125, 224	Sphygmomanometers	64 - 77
Retractors - Single Hook	128	Scissors - Umbilical	125	Sphygmomanometers - Accessories	77
Retriever - Coil	115	Scissors - Uterine	125	Sphygmomanometers - Boso	64 - 69, 71 - 77
Reusable ECG Electrodes	239	Screens - Mobile	177 - 178	Sphygmomanometers - Cuffs	77
Reusable Resuscitators	223	Screens - Privacy	177 - 179	Sphygmomanometers - Guardian	64, 66 - 69, 74 - 75, 77
Riester Specula	49	Screens - Wall Mounted	179	Spill Pak - Biohazard Kit	279
Rigi-Box	285	Screens - Ward	177 - 179	Spill Pak - Urine/Vomit Kit	279
Ring Cutter	128	Seive Pessary	114	Spills Kit - Cytotoxic Drug	279
Rolls - Couch	277	Sharps Bins	285	Spills Kit - Mercury	279
Rulers	90	Sharps Containers	285	Spills Kit - Urine And Vomit Kit	279
Rulers - ECG	239	Sharps Disposal	285	Spills Kits	279
Rusch Silkospray	131	Shoe Covers	293	Spirometers	246 - 255
Rydel Seiffert Tuning Fork	273	Sigmoidoscope Bellows	117	Spirometry Consumables	262 - 263
S		Sigmoidoscope Filters	117	Spirometry Paper	262
Safety Blood Lancets	287	Silkospray	131	Splinter Forceps	126
Safety Lancing Device	287	Sims Scissors	113	Splints	224
Sampling Brushes	114	Sims Uterine Curette	113	Stainless Steel Holloware	136
Scales	192 - 201	Sims Vaginal Speculum	113	Stainless Steel Rulers	90
Scales - Accessories	200	Sinus Forceps	129	Stainless Steel Trolleys	169 - 173
Scales - Baby & Toddler	194	Skeletons	294	Steps - Couch	166 - 167
Scales - Bed	197	Skin Freeze	123	Stethoscopes	80 - 87
Scales - Chair	196 - 197	Skin Hooks	128	Stethoscopes - Cardiology	80 - 81
Scales - Class Iii	193 - 198	Skin Markers	107	Stethoscopes - Child Friendly	84
Scales - Column	195, 198 - 199	Skin Marking Pens	107	Stethoscopes - Electronic	85
Scales - Floor	192 - 193	Skin Models	106, 295	Stethoscopes - Guardian	80 - 87
Scales - Health	192	Smoke Analysers	256 - 257	Stethoscopes - Littmann	80 - 87
Scales - Hoist	197	Soaps & Dispensers	280 - 283	Stethoscopes - Nurses	82 - 84
Scales - Wheelchair	196	Sonotrax Dopplers	243	Stools & Chairs	168, 175 - 176
Scissors	124 - 125	Spare Bulbs - Keeler	51	Strabismus Scissors	125
Scissors - Bandage	125	Spare Bulbs - Welch Allyn	51	Suction Pumps	210 - 213
Scissors - Chiroprody	130	Spatulas - Ayres	115	Surface Cleaning	280 - 283
Scissors - Dissecting	124	Spatulas - Cervical	114	Surface Wipes	280 - 283
Scissors - Dressing	124	Spatulas - Wooden	115	Sutures	278
Scissors - Iris	125	Specula	35, 46 - 49	Suturing Set	133
		Specula - 2G Guardian Generica	46 - 49		
		Specula - Generic Heine	46 - 47		

Index

Swabs	134	Tourniquets	218 - 219	Vaginal Speculum	110 - 113
Swan Freezers	204	Tourniquets - Disposable	219	Vaginal Speculum - Sims	110
Swan Refrigerators	202 - 205	Tourniquets - Guardian	218 - 219	Vaginal Speculum - Winterton	110
Syringe - Ear	135	Tourniquets - Prameta	219	Vaginal Speculum Set	112
Syringes	284	Tourniquets - Reusable	218 - 219	Vigorimeter	92
Syringes - Aural	129	Towel Clips	128	Vinyl Examination Gloves - Powder Free	274
T		Towel Dispenser	276 - 277	Vinyl Examination Gloves - Powdered	274
Tables - Baby Changing	174	Townley Calliper	90	Vitalograph - Spirometry	248 - 249, 252 - 254
Tables - Instrument	182 - 183	Training And Education	294 - 297	Volkman Curette	128
Tables - Mayo	182	Training Face Shields	225	Volkman Scoop	128
Tables - Treatment	182 - 183	Treatment - Trolleys	165, 169	Vusellum Forceps	113
Tape Measures	90	Treatment - Chairs	164	W	
Teale Forceps	113	Trial Frame	44	Waiting Room Furniture	191
Test Charts	45	Trial Lens Set	44	Wall Mounted - Diagnostic Sets	17, 20, 26 - 27
Theatre Lights	140	Trolleys - Auxiliary	169 - 173	Wall Mounted - Oscopes	17, 20, 26 - 27, 36
Therapy - Lamps	288	Trolleys - Care Tray	184	Wall Mounted - Screens	179
Therapy - Light	288	Trolleys - Dressing	169 - 173	Wall Rail Systems	179
Thermometers	88 - 90	Trolleys - Drug Dispensing	184	Wall Stations	22 - 23, 26 - 27, 31, 34, 36
Thermometers - Bath	90	Trolleys - ECG	238	Wall Thermometers	90
Thermometers - Clinical	90	Trolleys - Emergency	165	Wall Units - Diagnostic Sets	26 - 27
Thermometers - Dial	90	Trolleys - Equipment	169 - 173	Wall Units - Ophthalmic Sets	34
Thermometers - Digital	88 - 89	Trolleys - Instrument	169 - 173	Wall Units - Ophthalmoscopes	23, 26 - 27, 31
Thermometers - Dual Graduated	90	Trolleys - Oxygen Cylinder	183	Wall Units - Oscopes	22, 26 - 27
Thermometers - Ear	88 - 89	Trolleys - Patient	165	Wall Units - Retinoscopes	32
Thermometers - Infra Red	88 - 89	Trolleys - Pharmacy	184	Wall Units - Spare	36
Thermometers - Refrigerator	90	Trolleys - Stainless Steel	169 - 173	Ward Screens	177 - 179
Thermometers - Single Use Covers	89	Trolleys - Transport	165	Washable Covers	166
Thermometers - Wall	90	Trolleys - Treatment	165, 169 - 173	Waste - Bag Holder	185
Thermometers - Wooden	90	Trolleys - Under Couch	171	Watches	93
Thermoscan Braun	89	Tubing Clamp	127	Watchmaker Forceps	126
Thermoscan Probe Covers	89	Tubular Bandage Applicators	137	Welch Allyn - Bulbs	51
Thread Retriever	115	Tuning Forks	273	Welch Allyn - Specula	48
Thudicum Nasal Specula	129	Tuning Forks - Gardiner Brown	129, 273	Winterton Vaginal Speculum	111
Thudicum Specula	129	Tuning Forks - Guardian	273	Wooden Applicators	134
Tilley Forceps	129	Tuning Forks - Rydel Seiffert	273	Wooden Spatula	115
Tips	35, 46 - 49	Turnover End Forceps	126	X	
Tips - Dispensers	9, 17, 35	U		X-Ray Viewers	190
Tips - Ear	35, 46 - 49	Ultratech Dopplers	244 - 245	Z	
Tips - Ear Syringe	135	Urine Analysis	286 - 287	Ziegler Head Mirror	129
Tips - Hyfreator 2000	122	Urine Cups	134	Zoll Defibrillators	220 - 221
Tips - Oscope	35, 46 - 49	Uterine Curette	113		
Tips - Specula	35, 46 - 49	Uterine Dilator	113		
Toilet Paper	276	Uterine Scissors	113		
Toilet Paper Dispenser	276	Uterine Sound	113		
Tono Pen	44	UV Light	107		
Tonometer	44	V			
Tough Cut Scissors	125	Vacuaide	212		